



PRODUCTS CATALOG

MADE IN JAPAN SINCE 1923



CORPORATE PROFILE



Corporate name FUJIYA Co.,Ltd.
 Established September, 1923
 President Yasunobu Nozaki
 Capital 30 million yen
 Number of employees 210 people (as the group) (as of January,2020)
 Head Office 2-6-32, Matsubara, Higashi-Osaka City, Osaka Prefecture 578-0922, Japan
 e-mail global@fujiya-kk.com

Branch TOKYO / Ho Chi Minh (Viet Nam) / Ha Noi (Viet Nam)

FUJIYA group
 FUJIYA MANUFACTURING (Viet Nam) Co., Ltd.
 FUJIYA International Co., Ltd.
 VICTOR CO., LTD. (Osaka Japan)
 WISE CO., LTD. (Niigata Japan)

Description of business
 DIY stores, hardware stores, machine tool stores,
 electric facilities material stores

CRAFTSMANSHIP

It may be 'just' pliers—but it's pliers!

Tradition and innovation of FUJIYA, which has continued for more than 90 years
 With our skilled technology, we will continue to be committed to quality above all else.

Forging

The air gaps inside the metal are crushed, to enhance the strength and form the metal into the intended shape. This is the most important process that decides the quality of the product. By the fine-tuned checking of product quality, if there are products with poor quality, we immediately stop production to prevent poor-quality products from being sent to the next stage of the process. Additionally, when there are requests from the post-process, we always improve the forging to meet such requests.



Machining process

First, the metal is machined to make it closer to the shape of a final product. You might think it's 'nothing but pliers'. But we do process the metal, using many machines, to make a single pair of pincers. We make proper adjustments of individual machines, committing ourselves to making only the highest-quality products.



Assembly

After combining the right and left parts by inserting a pin, the operator manually makes adjustments. For the first time, the metal is formed into a pair of pliers. In this process, the left and right parts, sent separately from the machining process, are assembled into a single item. Since this process is the groundwork for the post-process, the operator checks each pair of pliers, individually, to make sure there is absolutely zero mis-alignment when the left and right parts are assembled, making delicate adjustments, if necessary.



Quenching

After quenching the entire part, the operator applies high-frequency induction quenching to increase the hardness of the tips. The operator applies quenching equally to the left and right blades to increase the hardness, in order to produce highly durable blades of equal hardness. However, if the metal is too hard, it becomes rather brittle. Therefore, we check the products with rigorous standards, by conducting tests on body hardness, blade hardness and impact resistance.



Edge sharpening

If the edges of right and left blades hit each other accurately, their durability becomes inferior, while if they are overlapped too much, the sharpness becomes inferior. This process decides the cutting sharpness, which is the most important for all types of pliers. The bottom ends of the blades are used for cutting, in the case of side cutting pliers, while the top ends of the blades are used for cutting, in the case of nippers. Therefore, the operator manually sharpens the edges of blades, one by one, by thinking about how the products will actually be used. In addition, since durability depends on how the edges are sharpened, the operator conducts the edge sharpening operation by being conscious, not only of its sharpness, but also its durability.



Polishing

In this finishing process, the products are carefully polished. This process is not directly related to the function of the product. However, if a product has a poor appearance, customers will be reluctant to pick them up from the shop counter. Therefore, we carefully polish our products by paying full attention to appearance, including the balance between the left and right parts, uniformity among each product and offer beautifully polished surfaces.



History of Fujiya

since 1923

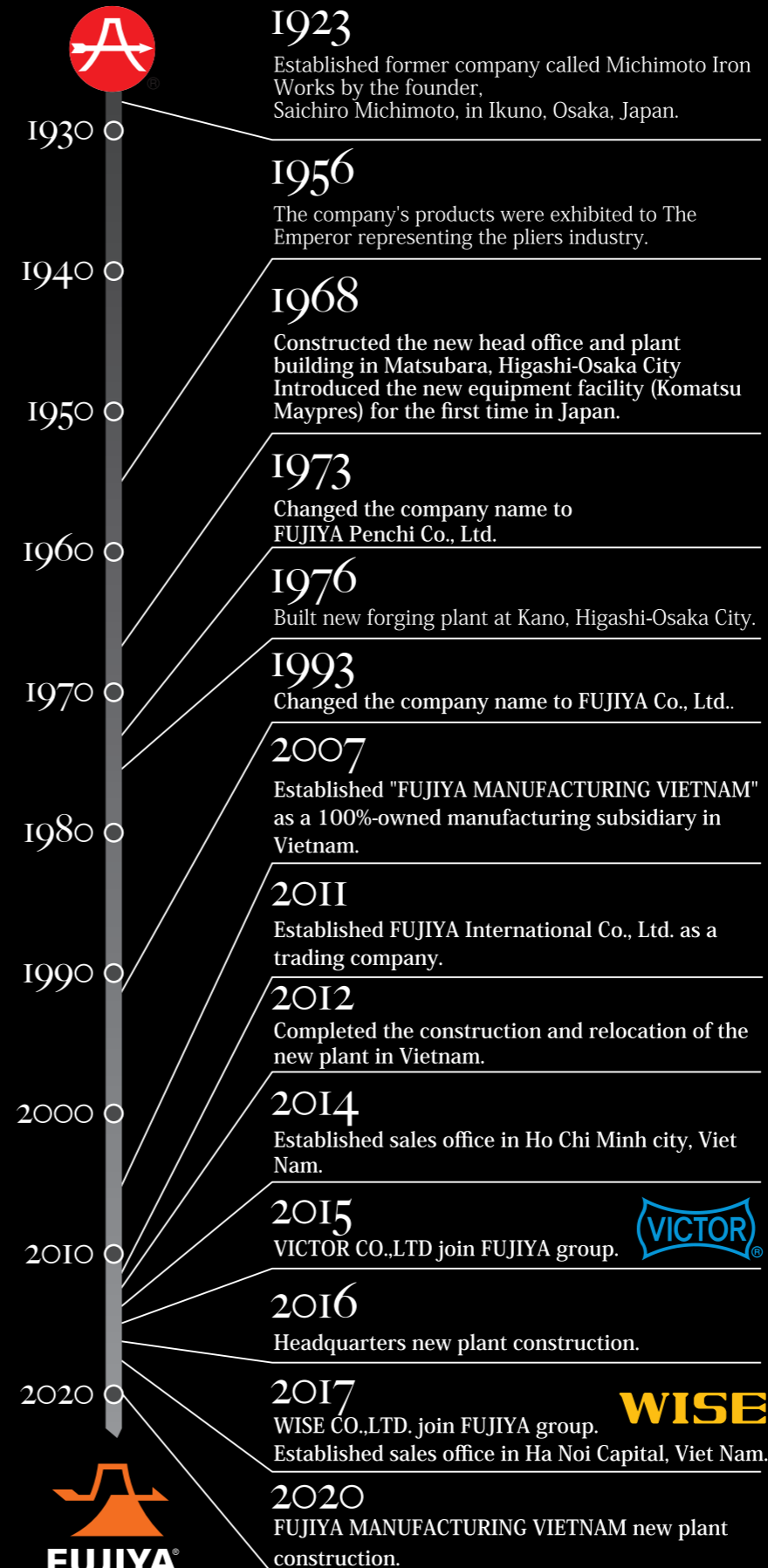

FUJIYA FACTORY



World wide

Fujiya has established a global supply system that comes from its three production facilities in Osaka, Japan, Niigata, Japan, and Fujiya Vietnam. We work hard to meet our customer's needs.

Headquarters & OSAKA Factory

The head production facility in Osaka is our machining center which focuses on product and technological development. We work on creating cutting edge tools through highly precise processing technology and our uniquely developed quenching process which involves laser heat treatment.



VIETNAM Factory

At Fujiya Vietnam, the same high-quality products from Japan are produced under the careful watch of skilled workers who underwent training in Japan.



NIIGATA Factory(WISE)

The Niigata production facility focuses on the production of ballpoint wrenches and screwdrivers which feature excellent rigidity and durability. These features are created via our uniquely developed heat treatment method.



PICTOGRAM

Strong Style

STRONG BLADES
Blades are at an obtuse angle and last exceptionally well.

Flat Type

STRAIGHT BLADES
Best for curved gate cuts.

ROUND BLADES
Suitable for flat gate cuts.

MICRO MIRROR BLADE
These blades feature Fujiya's own "Micro Mirror Blade" which was developed through polishing technology. They allow for simple cuts, and leave a beautiful cut cross section.

STANDARD MODEL
A popular standard model loved by many of our customers.

with SPRING MODEL
The spring makes these suitable for work involving repeated cutting.

ROHS COMPLIANT
This item is ROHS approved.

ELASTOMER GRIP HANDLE
Use an elastomer resin grip that is both gentle on the environment and fits perfectly in one's hand.

SAFETY APPLICABLE
Comes with a hole in the grip for attaching to a safety cord.

WIDTH of BLADE
Displays the blade width.

STAINLESS PRODUCT
Made with stainless steel and is rust-resistant.

ALUMINUM
Made stronger and lighter with an aluminum body and so the user doesn't tire out.

EASY CUTTING
Items are easier-to-cut with diagonal blades and by placing the rivet at point A.

SMALLHOLE on BLADES
Comes with stripping function for covered wires.

CRIMPING FUNCTION
Equipped with a convenient, simple crimping function that's helpful on worksites.

PLIER FUNCTION
There is a large indentation at the base of the jaws, leading the tool to function as pliers, too.

ESD APPLICABLE
The grips reduce static electricity for short periods of time and resist electrocution.

CUTTING FUNCTION
Comes with cutting function.

SOFT GRIP HANDLE
This grip design was created via ergonomics. It's soft, able to be used for long periods of time, and reduces stress on hand when in use.

with INDENTATION
Jaws are indented in order to assure that gripped items will not slip.

without INDENTATION
Jaws are flat in order to not damage anything gripped.

STOPPER FUNCTION
Comes with easy-to-use safety stopper and is secure when stored.

BENT TYPE
The nose is bent, making it more user-friendly.

CLIPPER
Blades are clipper-type.

DETACHABLE CLAW TYPE
Claw can be detached from the main body with one screw.

MICRO EDGE
The base of the jaws are indented in order to help secure the item being cut.

WIRE CUT FUNCTION
(Annealing) wires up to 2mm in diameter (max #14) can be cut with these. Tools with this icon can also cut up to three #18 (1.2mm diameter) wires at once.

NON SCATTERING DEVICE
Coated with a non-scattering plate so no fragments scatter when cut.

EXCLUSIVE TOOL
This item is Exclusive tool.

NEW INDENTATION SHAPE
Jaws hold a better grip than their original counterparts.

DETACHABLE BLADE TYPE
If the blade becomes dull, then it can be replaced with a new one to make it like-new.

JIS JQA
FUJIYA JAPAN (JQ0509059) SIDE CUTTING PLIERS 4623) ANGLE CUTTING NIPPERS 4625) FUJIYA VIETNAM (JQV09001) LONG NOSE PLIERS 4631) DIAGONAL CUTTING NIPPERS 4635)

A-SERIES

PLIERS, NIPPERS, LONG NOSE PLIERS

MINITECH PLASTIC NIPPERS.....	8
PLASTIC CUTTING NIPPERS	8
MINITECH SMALL NIPPERS	9
MINI NIPPERS	9
STANDARD NIPPERS	9
DIAGONAL CUTTING NIPPERS	10
SIDE CUTTING PLIERS.....	10
HIGH LEVERAGE LINEMAN'S PLIERS	10
MINITECH SHORT NOSE PLIERS	11
LONG NOSE PLIERS	11
MULTI-PURPOSE LONG NOSE PLIERS	11
MINITECH TWEEZER LONG NOSE PLIERS	12
MINITECH TWEEZER LONG NOSE PLIERS BENT TYPE	12
CABLE HANDY CUTTERS	12
LONG NOSE PLIERS for WELDING WORKS	12



MINITECH PLASTIC NIPPERS

APN-110FS



Small-type can fit in one's palm and is suitable for delicate work.

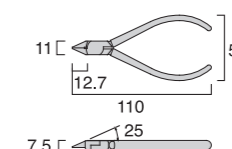

No.	SIZE mm	WEIGHT g/w	CUTTING PERFORMANCE		PACKAGE SIZE HxWxDmm	Quantity	JAN CODE
			RESIN mm				
APN-110FS	110	60	Φ3.0		170×73×15	6	341018

PLASTIC CUTTING NIPPERS

APN-125FS, 150FS



These are the golden standard of nippers. It makes it harder for springs to drop. Best for curved gate cuts.

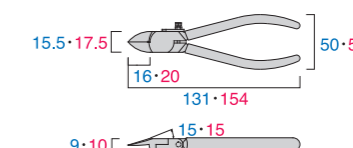

No.	SIZE mm	WEIGHT g/w	CUTTING PERFORMANCE		PACKAGE SIZE HxWxDmm	Quantity	JAN CODE
			RESIN mm				
APN-125FS	125	90	Φ3.0		170×73×15	6	340004
APN-150FS	150	125	Φ5.0		200×73×15	6	340011

PLASTIC CUTTING NIPPERS

APN-125RS, 150RS



These are the golden standard of nippers. It makes it harder for springs to drop. Suitable for flat gate cuts.

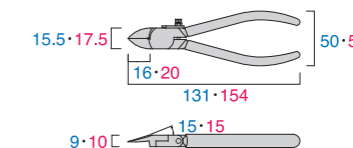

No.	SIZE mm	WEIGHT g/w	CUTTING PERFORMANCE		PACKAGE SIZE HxWxDmm	Quantity	JAN CODE
			RESIN mm				
APN-125RS	125	90	Φ3.0		170×73×15	6	340028
APN-150RS	150	125	Φ5.0		200×73×15	6	341001

※The last six digits of JAN (Japanese Article Numbering) Code are displayed with the manufacturer code [4952520] omitted.

MINITEC SMALL NIPPERS

AMN-110S



Very small blades part, most suitable to cutting work in narrow space and cut super thin wire.

No.	SIZE mm	WEIGHT g/w	CUTTING PERFORMANCE				PACKAGE SIZE H×W×Dmm	Quantity	JAN CODE
			SOFT STEEL WIRE mm	COPPER WIRE mm	TWISTED WIRE mm	PIANO WIRE mm			
AMN-110S	110	60	Φ1.0	Φ1.8	Φ2.0	—	170×73×15	6	341025

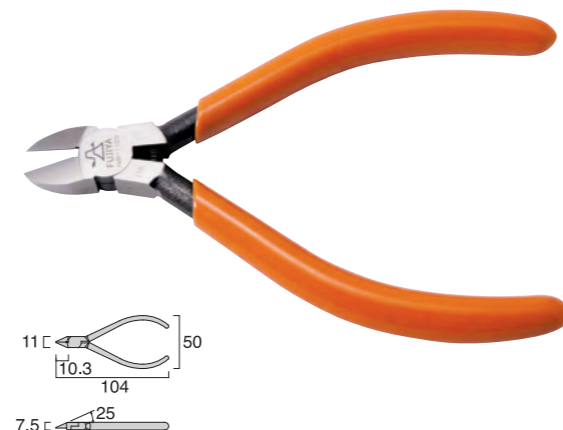

MINI NIPPERS

AMN-125S



Very small blades part, most suitable to cutting work in narrow space and cut super thin wire.

No.	SIZE mm	WEIGHT g/w	CUTTING PERFORMANCE				PACKAGE SIZE H×W×Dmm	Quantity	JAN CODE
			SOFT STEEL WIRE mm	COPPER WIRE mm	TWISTED WIRE mm	PIANO WIRE mm			
AMN-125S	125	70	Φ1.6	Φ2.0	—	—	170×73×15	6	341032

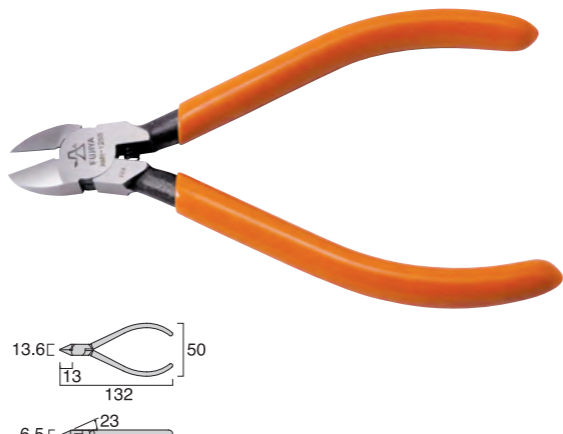

MINI NIPPERS

ATMN-120S



Ideal for cutting fine wire.

No.	SIZE mm	WEIGHT g/w	CUTTING PERFORMANCE				PACKAGE SIZE H×W×Dmm	Quantity	JAN CODE
			SOFT STEEL WIRE mm	COPPER WIRE mm	TWISTED WIRE mm	PIANO WIRE mm			
ATMN-120S	120	75	Φ0.8	Φ1.2	—	—	170×73×15	6	341049

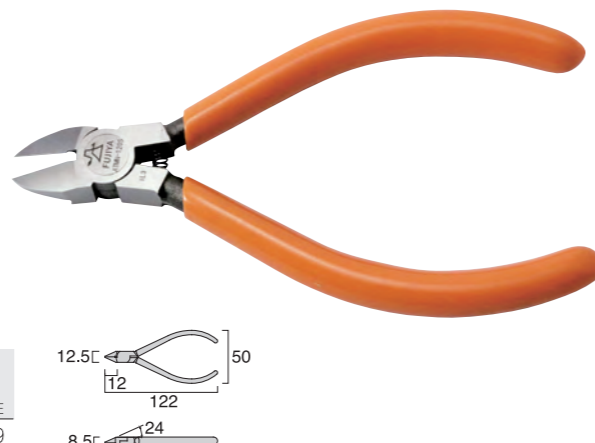

STANDARD NIPPERS

ASN-125S,150S



Very small blades part, most suitable to cutting work in narrow space and cut super thin wire.

No.	SIZE mm	WEIGHT g/w	CUTTING PERFORMANCE				PACKAGE SIZE H×W×Dmm	Quantity	JAN CODE
			SOFT STEEL WIRE mm	COPPER WIRE mm	VA-VVF CABLE	PIANO WIRE mm			
ASN-125S	125	80	Φ1.2	Φ2.0	—	—	170×73×15	6	341100
ASN-150S	150	110	Φ1.6	Φ2.6	—	—	200×73×15	6	341117

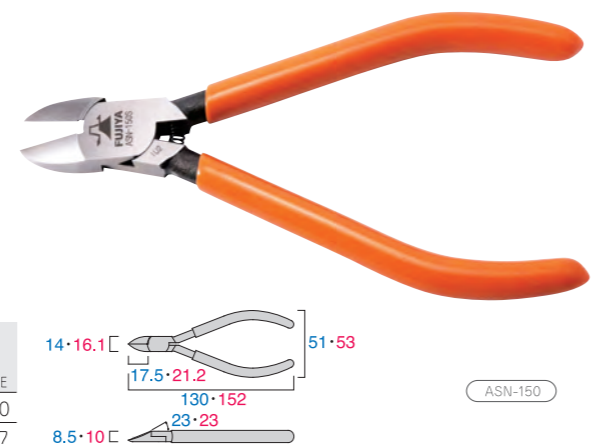

DIAGONAL CUTTING NIPPERS

AKN-150,175,200



Made of high grade alloy steel and specially heat-treated for the professional use. Longer and tougher cutting blade than before makes better cutting performance and durability.

No.	SIZE mm	WEIGHT g/w	CUTTING PERFORMANCE				PACKAGE SIZE H×W×Dmm	Quantity	JAN CODE
			SOFT STEEL WIRE mm	COPPER WIRE mm	TWISTED WIRE mm	PIANO WIRE mm			
AKN-150	150	190	Φ2.0	Φ3.0	—	Φ1.0	200×73×20	6	341056
AKN-175	175	240	Φ2.0	Φ3.0	—	Φ1.2	223×73×20	6	343036
AKN-200	200	320	Φ3.0	Φ3.5	—	Φ1.2	223×73×20	6	343043

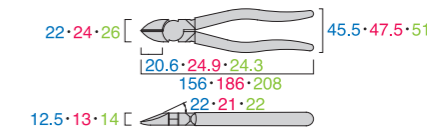

SIDE CUTTING PLIERS

AP-150,175,200



This model is lightweight and strong. It is toughness and sharpness, use specific iron. There is holding indentation so it is easy to grab objects.

No.	SIZE mm	WEIGHT g/w	CUTTING PERFORMANCE				PACKAGE SIZE H×W×Dmm	Quantity	JAN CODE
			SOFT STEEL WIRE mm	COPPER WIRE mm	VA-VVF CABLE	PIANO WIRE mm			
AP-150	150	180	Φ2.2	Φ3.0	—	—	200×73×18	6	342060
AP-175	175	285	Φ3.0	Φ3.5	—	—	223×73×20	6	342077
AP-200	200	365	Φ3.4	Φ4.0	—	—	253×73×20	6	342084



AP-200

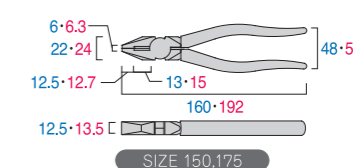

HIGH LEVERAGE LINEMAN'S PLIERS

APP-225



Thin and light model. Diagonal blades make it easier to smoothly cut piano wire.

No.	SIZE mm	WEIGHT g/w	CUTTING PERFORMANCE				PACKAGE SIZE H×W×Dmm	Quantity	JAN CODE
			SOFT STEEL WIRE mm	COPPER WIRE mm	VA-VVF CABLE	PIANO WIRE mm			
APP-225	225	340	Φ3.6	Φ4.0	2.6×3core	—	270×73×20	6	340035

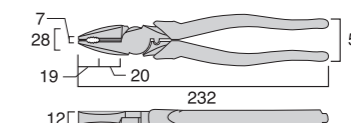

※The last six digits of JAN (Japanese Article Numbering) Code are displayed with the manufacturer code [4952520] omitted.

※The last six digits of JAN (Japanese Article Numbering) Code are displayed with the manufacturer code [4952520] omitted.

MINITEC SHORT NOSE PLIERS AR-110S



Thin and short nose tips are good for precision gripping and bending work.

No.	SIZE mm	WEIGHT g/w	CUTTING PERFORMANCE		PACKAGE SIZE HxWxDmm	Quantity	JAN CODE
			SOFT STEEL WIRE mm	COPPER WIRE mm			
AR-110S	110	57	Φ1.0	Φ1.5	170×73×12	6	342039

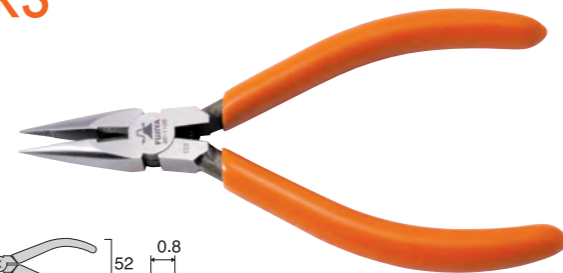
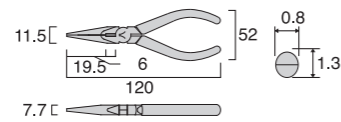

LONG NOSE PLIERS AR-125S,150S



Thin and short nose tips are good for precision gripping and bending work.

No.	SIZE mm	WEIGHT g/w	CUTTING PERFORMANCE		PACKAGE SIZE HxWxDmm	Quantity	JAN CODE
			SOFT STEEL WIRE mm	COPPER WIRE mm			
AR-125S	125	95	Φ1.5	Φ2.6	170×73×12	6	342015
AR-150S	150	120	Φ1.5	Φ2.6	200×73×15	6	342022

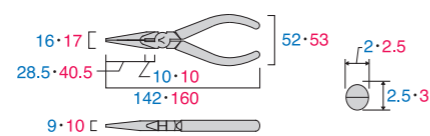

MULTI-PURPOSE LONG NOSE PLIERS AMR-150S



Six different functions are integrated into this single tool.
Hold/Turn/Crack/Strippe/Crimping/Cut

No.	SIZE mm	WEIGHT g/w	CUTTING PERFORMANCE		PACKAGE SIZE HxWxDmm	Quantity	JAN CODE
			SOFT STEEL WIRE mm	COPPER WIRE mm			
AMR-150S	150	120	Φ1.5	Φ2.6	200×73×15	6	342008

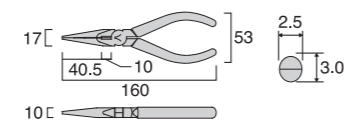

MINITECH TWEEZER LONG NOSE PLIERS ATR-150S



Specially suitable for precision works due to the head of thin and long without holding indentation.

No.	SIZE mm	WEIGHT g/w	CUTTING PERFORMANCE		PACKAGE SIZE HxWxDmm	Quantity	JAN CODE
			SOFT STEEL WIRE mm	COPPER WIRE mm			
ATR-150S	150	50	Φ0.8	Φ1.2	200×73×15	6	342046

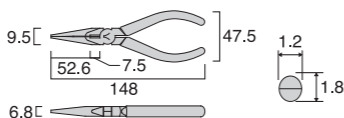

MINITECH TWEEZER LONG NOSE PLIERS(BENT) ATR-150SB



The nose part is a bent-type.
Specially suitable for precision works due to the head of thin and long without holding indentation.

No.	SIZE mm	WEIGHT g/w	CUTTING PERFORMANCE		PACKAGE SIZE HxWxDmm	Quantity	JAN CODE
			SOFT STEEL WIRE mm	COPPER WIRE mm			
ATR-150SB	150	50	Φ0.9	Φ1.3	200×73×15	6	342053

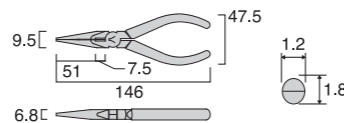

CABLE HANDY CUTTERS ACC-150



Cutting for rubber and urethane.
Heat treatment process at our own standard provides outstanding sharpness and durability.

No.	SIZE mm	WEIGHT g/w	CUTTING PERFORMANCE			PACKAGE SIZE HxWxDmm	Quantity	JAN CODE
			SOFT STEEL WIRE mm	COPPER WIRE mm	IV CABLE			
ACC-150	150	150	—	—	22mm ² φ9.2	6	343005	

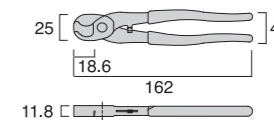

CABLE HANDY CUTTERS ACC-200



Cutting for rubber and urethane.
Heat treatment process at our own standard provides outstanding sharpness and durability.

No.	SIZE mm	WEIGHT g/w	CUTTING PERFORMANCE			PACKAGE SIZE HxWxDmm	Quantity	JAN CODE
			SOFT STEEL WIRE mm	COPPER WIRE mm	IV CABLE			
ACC-200	200	285	—	—	38mm ² φ11.4	6	343012	

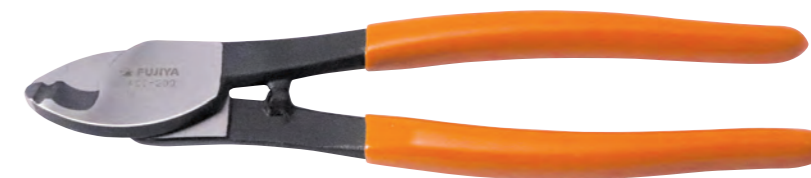
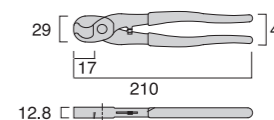

LONG NOSE PLIERS for WELDING WORK(STRAIGHT) AWS-150S



For welding work
Spatter at the tip of the nozzle can be removed.
For welding nozzle tip attachment / detachment work
Pull out the wire and cut it.

No.	SIZE mm	WEIGHT g/w	CUTTING PERFORMANCE			PACKAGE SIZE HxWxDmm	Quantity	JAN CODE
			SOFT STEEL WIRE mm	COPPER WIRE mm	IV CABLE			
AWS-150S	160	140	Φ1.5	Φ2.6	—	6	342206	

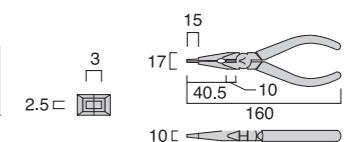

LONG NOSE PLIERS for WELDING WORK(BENT) AWB-150S



For welding work
Spatter at the tip of the nozzle can be removed.
For welding nozzle tip attachment / detachment work
Pull out the wire and cut it.

No.	SIZE mm	WEIGHT g/w	CUTTING PERFORMANCE			PACKAGE SIZE HxWxDmm	Quantity	JAN CODE
			SOFT STEEL WIRE mm	COPPER WIRE mm	IV CABLE			
AWB-150S	160	140	Φ1.5	Φ2.6	—	6	342213	

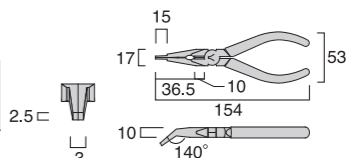

※The last six digits of JAN (Japanese Article Numbering) Code are displayed with the manufacturer code [4952520] omitted.

※The last six digits of JAN (Japanese Article Numbering) Code are displayed with the manufacturer code [4952520] omitted.

KUROKIN



HIGH LEVERAGE SIDE CUTTING PLIERS	14
HIGH LEVERAGE DIAGONAL CUTTING NIPPERS	14
DIAGONAL CUTTING NIPPERS	14
ADJUSTABLE WRENCH	15
ADJUSTABLE WRENCH SHORT TYPE	15
ADJUSTABLE WRENCH THIN TIP TYPE	15
ADJUSTABLE WRENCH with RACHET WRENCH	16
QUICK ADJUSTABLE WRENCH	16
SLIP JOINT COMBINATION PLIERS <BENT TYPE>	17
LIGHTWEIGHT SLIP JOINT COMBINATION PLIERS	17
LIGHTWEIGHT WATER PUMP PLIERS	17
WATER PUMP PLIERS	17
PLIERS WRENCHES	18
REVERSIBLE JAW PIPE WRENCH	18
VA(VVF) CABLE STRIPPERS	19
HEAVY DUTY DIAGONAL CLIPPERS	19
SAFETY CODE with LOCK FUNCTION 5kg	20
SAFETY CODE 5kg	20
SAFETY CODE 3kg	20
SAFETY CODE SLIM TYPE 3kg	20
SAFETY CODE SLIM TYPE 1kg	20
SAFETY CODE TWIN HOOK TYPE 3kg	20
WAIST HOLDER BAG	21
PLIER HOLDER	21
SUPPORT BELT	21
WORK BELT	21

HIGH LEVERAGE SIDE CUTTING PLIERS

3000N-200BG, 225BG



Diagonal blades make it easier to smoothly cut piano wire.



No.	SIZE mm	WEIGHT g/w	CUTTING PERFORMANCE				PACKAGE SIZE HxWxDmm	Quantity	JAN CODE
			STEEL WIRE mm	COPPER WIRE mm	PIANO WIRE mm	VA-VVF mm			
3000N-200BG	200	270	Φ3.4	Φ4.0	Φ1.6	Φ2.0×3core	253×73×20	6	030882
3000N-225BG	225	340	Φ3.6	Φ4.1	Φ2.0	Φ2.6×3core	270×73×20	6	030899

HIGH LEVERAGE DIAGONAL CUTTING NIPPERS

700N-175BG, 200BG



Diagonal blades make it easier to smoothly cut piano wire.

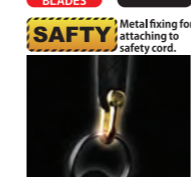

No.	SIZE mm	WEIGHT g/w	CUTTING PERFORMANCE				PACKAGE SIZE HxWxDmm	Quantity	JAN CODE
			STEEL WIRE mm	COPPER WIRE mm	PIANO WIRE mm	VA mm			
700N-175BG	175	270	Φ3.6	Φ4.2	Φ2.0	Φ1.6×3core	223×73×20	6	077177
700N-200BG	200	330	Φ4.0	Φ5.0	Φ2.5	Φ2.0×3core	251×73×22	6	077184

HIGH LEVERAGE DIAGONAL CUTTING NIPPERS

7700N-175BG, 200BG



These nippers are designed for VVF and VA cables with a Fujiya record-setting sharpness. They are diagonal and feature Fujiya's own "Micro Mirror Blade" developed through polishing technology.

*Due to the blade being thin, these nippers will not cut through piano wire, spring wire, and wire cable.



No.	SIZE mm	WEIGHT g/w	CUTTING PERFORMANCE				PACKAGE SIZE HxWxDmm	Quantity	JAN CODE
			STEEL WIRE mm	COPPER WIRE mm	PIANO WIRE mm	VA mm			
7700N-175BG	175	250	—	Φ3.5	—	Φ2.6×3core	225×75×20	6	077191
7700N-200BG	200	320	—	Φ3.5	—	Φ2.6×3core	250×75×22	6	077207

DIAGONAL CUTTING NIPPERS

770N-175BG, 200BG



Recommended the most for cutting VVF cables (VA Cables and F Cables), copper wire, and soft steel wire.

*These nippers will not cut through piano wire, spring wire, and wire cable.

*The spring is removable.

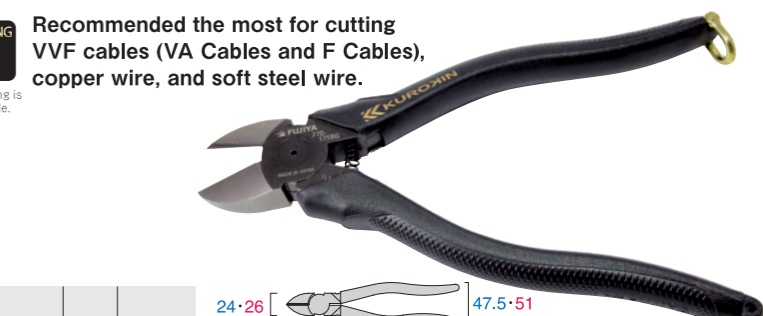

No.	SIZE mm	WEIGHT g/w	CUTTING PERFORMANCE				PACKAGE SIZE HxWxDmm	Quantity	JAN CODE
			STEEL WIRE mm	COPPER WIRE mm	PIANO WIRE mm	VA mm			
770N-175BG	175	240	Φ2.0	Φ3.0	—	Φ2.0×3core	224×76×21	6	077214
770N-200BG	200	320	Φ2.5	Φ3.5	—	Φ2.6×3core	252×77×25	6	077221

HIGH-LEVERAGE MECHANISM POWER UP!

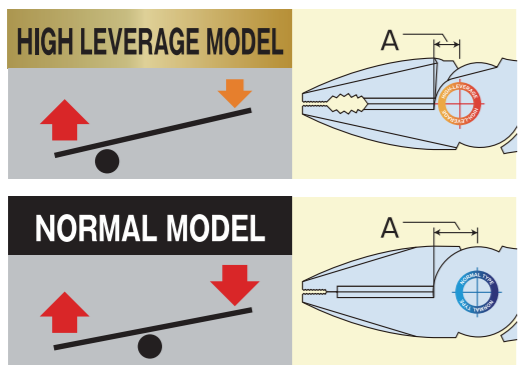

Having rivet placed closer to the cutting edges to provide more leverage.

Rivet placed further to the cutting edges requires more force when cutting.



ADJUSTABLE WRENCH

FLA-28-BG,FLA-32-BG
FLA-43-BG,FLA-53-BG



The teeth feature a unique design so as to not damage bolts. The blade is thin and these are light, however, it's powerful enough to have cleared the Strength Class of the Japanese Industrial Standards.

No.	SIZE mm	MAXIMUM OPENING mm	WEIGHT g/w	Quantity	JAN CODE
FLA-28-F	155	0~28	114	6	852000
FLA-32-F	205	0~32	191	6	852217
FLA-43-F	256	0~43	277	6	852224
FLA-53-F	306	0~53	490	6	852231

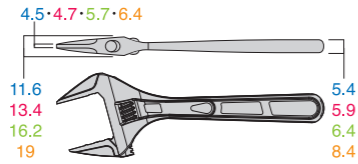

ADJUSTABLE WRENCH SHORT TYPE

FLS-28-BG,FLS-32-BG
FLS-43-BG,FLS-53-BG



Shorter style for easy rotation in narrow locations.

No.	SIZE mm	MAXIMUM OPENING mm	WEIGHT g/w	Quantity	JAN CODE
FLS-28G-F	118	0~28	103	6	852262
FLS-32G-F	139	0~32	154	6	852279
FLS-43G-F	156	0~43	235	6	852286
FLS-53G-F	185	0~53	398	6	852293

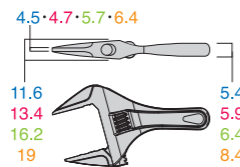

ADJUSTABLE WRENCH THIN TIP TYPE

FLT-34-BG,FLT-38-BG



The nose is 3.5mm in thickness and thin. As such, it is able to be used to rotate nuts with narrow parts such as when securing casters.

※FLT-34-BG



For caster fittings.

For double nut fittings.

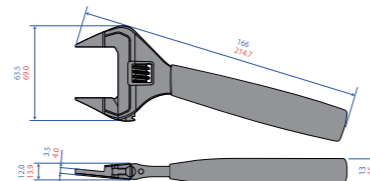

No.	SIZE mm	MAXIMUM OPENING mm	WEIGHT g/w	PACKAGE SIZE HxWxDmm	Quantity	JAN CODE
FLT-34-BG	166	0~34	154	235x106x13	6	852330
FLT-38-BG	214	0~38	284	288x114x16	6	852316

※The last six digits of JAN (Japanese Article Numbering) Code are displayed with the manufacturer code [4952520] omitted.

ADJUSTABLE WRENCH with RATCHET WRENCH

FGL-38-BG



This monkey wrench offers a mouth with a maximum opening of 38mm, and makes an excellent construction site scaffolding companion as it is combined with a 17mm socket wrench. The handle also has a 10mm and 13mm offset wrench mouth.



38mm WIDE OPEN



17mm Ratchet wrench

No.	SIZE mm	MAXIMUM OPENING mm	WEIGHT g/w	PACKAGE SIZE HxWxDmm	Quantity	JAN CODE
FGL-38-BG	220	0~38	280	270x122x15	6	852255

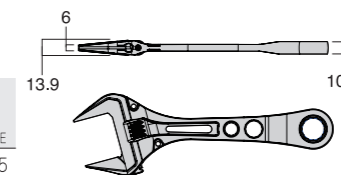

QUICK ADJUSTABLE WRENCH

FGP-32-BG



For all nuts and bolts from M3 to M10 size, the wrench can be used repeatedly to loosen or tighten. It's perfect for maintenance work.

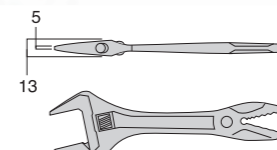

No.	SIZE mm	MAXIMUM OPENING mm	WEIGHT g/w	PACKAGE SIZE HxWxDmm	Quantity	JAN CODE
FGP-32-BG	203	0~32	245	272x117x15	6	852248

※The last six digits of JAN (Japanese Article Numbering) Code are displayed with the manufacturer code [4952520] omitted.

SLIP JOINT COMBINATION PLIERS <BENT TYPE>

210-190-BG



A better grip is provided for pipes and nuts due to the jaws being diamond-shaped. Perfect for working on cars and farm equipment, as well as joining two box connectors.

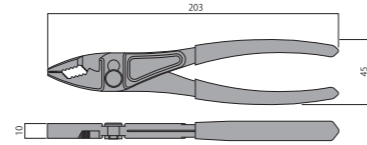

No.	SIZE mm	WEIGHT g/w	CUTTING PERFORMANCE		PACKAGE SIZE HxWxDmm	Quantity	JAN CODE
			STEEL WIRE mm				
210-190-BG	193	246	Φ2.0		232×75×15	6	853085

LIGHTWEIGHT SLIP JOINT COMBINATION PLIERS

230-165-BG, 230-200-BG



A better grip is provided for pipes and nuts due to the jaws being diamond-shaped. Perfect for working on cars and farm equipment, as well as joining two box connectors.

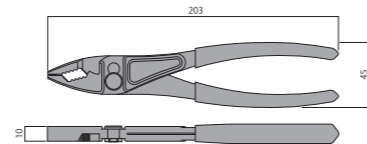

No.	SIZE mm	WEIGHT g/w	CUTTING PERFORMANCE		PACKAGE SIZE HxWxDmm	Quantity	JAN CODE
			STEEL WIRE mm				
230-165-BG	168	125	Φ2.0		205×75×7	6	853061
230-200-BG	203	200	Φ2.6		243×75×7	6	853078

LIGHTWEIGHT WATER PUMP PLIERS

130-200-BG, 130-250-BG



A better grip is provided for pipes and nuts due to the jaws being diamond-shaped.

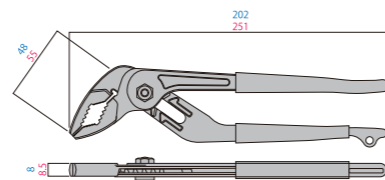

No.	SIZE mm	WEIGHT g/w	WORKING CAPACITY		PACKAGE SIZE HxWxDmm	Quantity	JAN CODE
			PIPE	NUT			
130-200-BG	202	172	Φ42~8.5	Φ27~5	267×75×15	6	853047
130-250-BG	251	294	Φ48~9	Φ30~6	315×75×17	6	853054

WATER PUMP PLIERS

110-250S-BG, 110-250SD-BG



Press the handle to the bottom to release the spring. This makes for compact storage when done. Raise the handle, and the coil will move. This reduces burden while working.



110-250SD-BG

110-250S-BG

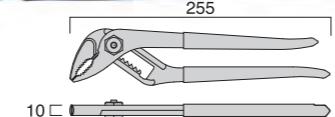

No.	SIZE mm	WEIGHT g/w	MAXIMUM OPENING mm	PACKAGE SIZE HxWxDmm	Quantity	JAN CODE
110-250S-BG	255	320	47	290×80×20	6	853009
110-250SD-BG	255	320	47	290×80×20	6	853016

※The last six digits of JAN (Japanese Article Numbering) Code are displayed with the manufacturer code [4952520] omitted.

PLIERS WRENCH pliers and a wrench in a single tool

FLM-45-BG



This is the "Grip Monkey Wrench" which has been designed to overcome the flaws of the original monkey wrench. With the press of a single button, the wrench will grip onto the target perfectly and adjust as necessary. Thus leading to a powerful grip.



The width of the wrench can be adjusted quickly with the press of a single button. The gripping surface moves at the same time to grip, allowing for a perfect adjustment and powerful grip.

It allows for repeated use, including tightening and loosening.

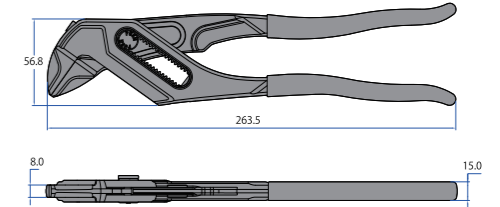

No.	SIZE mm	MAXIMUM OPENING mm	WEIGHT g/w	PACKAGE SIZE HxWxDmm	Quantity	JAN CODE
FLM-45-BG	263.5	0~45	522	334×76×18	6	852309

REVERSIBLE JAW PIPE WRENCH

FLP-38-BG



By replacing the jaw parts, this can serve as both a monkey wrench and a pipe wrench.

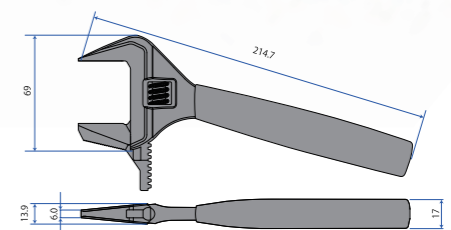
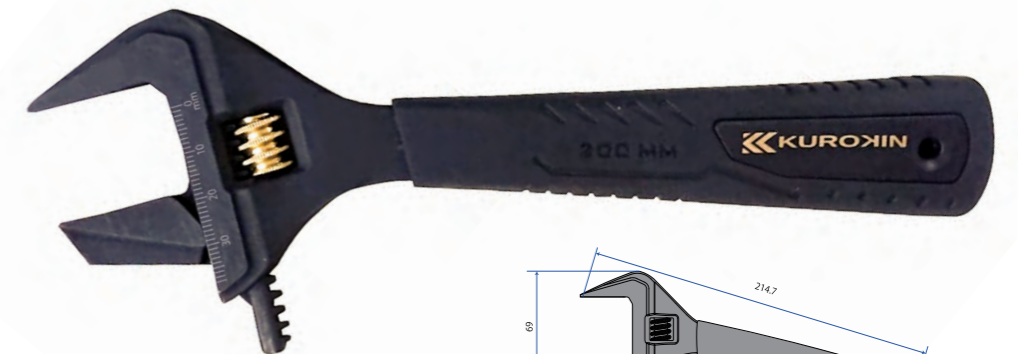

No.	SIZE mm	MAXIMUM OPENING mm	WEIGHT g/w	PACKAGE SIZE HxWxDmm	Quantity	JAN CODE
FLP-38-BG	214	0~38.5	316	290×112×17	6	852323

※The last six digits of JAN (Japanese Article Numbering) Code are displayed with the manufacturer code [4952520] omitted.

VA CABLE STRIPPERS

FVA101-BG



Easily strip VA Cables.
Produces incredibly effective work for the ECEE.
Comes with gauge estimator.



Outer cable sheath



Inner cable sheath



No.	SIZE mm	WEIGHT g/w	WIRE SIZE				PACKAGE SIZE HxWxDmm	Quantity	JAN CODE
			VVF, EM600V	EEF/F					
FVA101-BG	180	350	Φ1.6×2core	Φ1.6×3core	Φ2.0×2core	Φ2.0×3core	245×115×60	6	083437

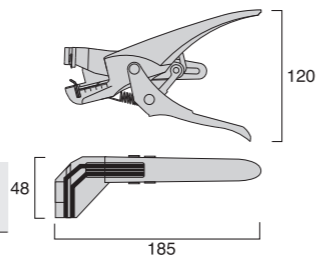

HEAVY DUTY DIAGONAL CLIPPERS

PC11-200BG, PC12-200BG



Best for cutting piano wires!



PC11-200BG

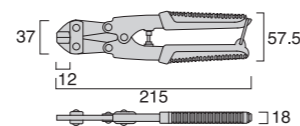

PC12-200BG

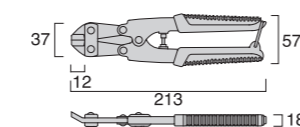

No.	SIZE mm	WEIGHT g/w	CUTTING PERFORMANCE		PACKAGE SIZE HxWxDmm	Quantity	JAN CODE
			STEEL WIRE mm	PIANO WIRE mm			
PC11-200BG	200	160	Φ4.0	Φ2.0	290×80×20	6	065099
PC12-200BG	200	165	Φ4.0	Φ2.0	290×80×20	6	065105

※The last six digits of JAN (Japanese Article Numbering) Code are displayed with the manufacturer code [4952520] omitted.



By connecting tools to a safety belt, accidents, such as dropping one's tools from high places, can be avoided.

Work efficiency is increased because specially woven fibers have rubber sewn into them and allow for expansion and contraction.

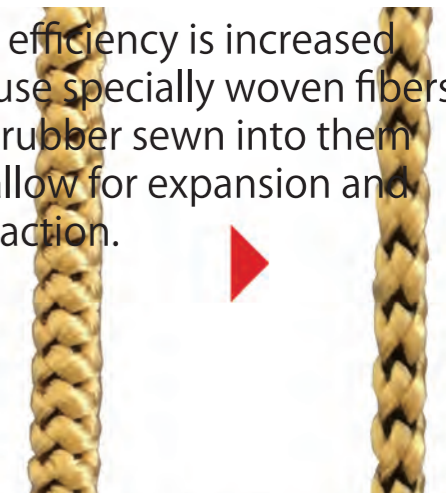

SAFETY CODE with LOCK FUNCTION 5kg

FSC-5BK-SR, FSC-5BK-GD

This model comes with a carabiner with a lock on one side.

No.	WEIGHT g/w	SIZE mm	USE WEIGHT g/w	Quantity	JAN CODE
FSC-5BK-SR	150	840~1500	5kg	10	411971
FSC-5GD-SR	150	840~1500	5kg	10	411964



SAFETY CODE 5kg/ 3kg

FSC-5BK, FSC-5GD, FSC-3BK, FSC-3GD

No.	WEIGHT g/w	SIZE mm	USE WEIGHT g/w	Quantity	JAN CODE
FSC-5BK	135	840~1500	5kg	10	411995
FSC-5GD	135	840~1500	5kg	10	411988
FSC-3BK	78	840~1500	3kg	10	412602
FSC-3GD	79	840~1500	3kg	10	412619



SAFETY CODE SLIM TYPE 3kg/1kg

FSC-3S-BK, FSC-3S-GD, FSC-1S-BK, FSC-1S-GD

This is a slim-type model which can be worn in narrow workspaces.

No.	WEIGHT g/w	SIZE mm	USE WEIGHT g/w	Quantity	JAN CODE
FSC-3S-BK	63	840~1400	3kg	10	412701
FSC-3S-GD	63	840~1400	3kg	10	412718
FSC-1S-BK	38	840~1340	1kg	10	412725
FSC-1S-GD	38	840~1340	1kg	10	412732



SAFETY CODE TWIN HOOK TYPE 3kg

FSC-3SW-BK, FSC-3SW-GD

Up to two tools can be attached to one cable at the same time.

No.	WEIGHT g/w	SIZE mm	USE WEIGHT g/w	Quantity	JAN CODE
FSC-3SW-BK	60	840~1400	3kg	10	412749
FSC-3SW-GD	60	840~1400	3kg	10	412756



※The last six digits of JAN (Japanese Article Numbering) Code are displayed with the manufacturer code [4952520] omitted.



Kurokin Storage Series

PVC vinyl fabric is used on the surface to repel both water and dirt. Perfect for those who work frequently on rooftop construction, or jobs where cleanliness is essential, like carpentry and remodeling.



Using water-shedding fabric

Ample Storage Space



Comes with a band on the front for securing pens and small nippers.



There's also a pocket inside for storing smaller items.

WAIST HOLDER BAG

PS-22BG / PS-23BG / PS-32BG



No.PS-22BG



No.PS-23BG



No.PS-32BG

No.	WEIGHT g/w	PACKAGE SIZE HxWxDmm	Quantity	JAN CODE
PS-22BG	451	255x190x105	20	412350
PS-23BG	503	255x190x130	20	412367
PS-32BG	407	255x160x105	20	412374

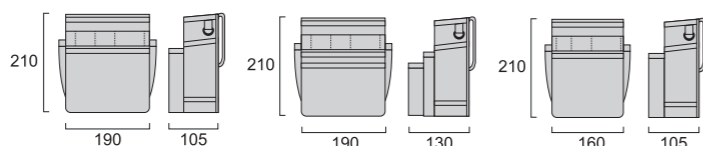

PLIER HOLDER

PS-51BG / PS-62BG / PS-72BG / PS-92BG

CLIPPER ×1



No.PS-51BG

PLIER or NIPPER ×2



No.PS-62BG

PLIER or NIPPER ×2,
Screw driver ×2



No.PS-72BG

Construction ratchet wrench ×1,
Adjustable wrench ×1



No.PS-92BG

No.	WEIGHT g/w	PACKAGE SIZE HxWxDmm	Quantity	JAN CODE
PS-51BG	70	320x91x29	50	412381
PS-62BG	88	320x91x68	50	412398
PS-72BG	108	320x91x78	50	412404
PS-92BG	100	320x91x72	50	412411

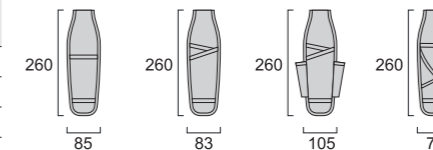

SUPPORT BELT

PS-SMBG / PS-SLBG

The inside is made with a body heat-resistant mesh. There's also an internal pocket for ice packs.



No.PS-SMBG

No.	WEIGHT g/w	PACKAGE SIZE HxWxDmm	Quantity	JAN CODE
PS-SMBG	330	820x130x45	25	412428
PS-SLBG	350	895x130x45	25	412435

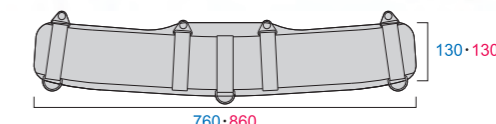

WORK BELT B-02BG

Work Belt made of robust, synthetic leather. (8 Belt Holes)



No.	WEIGHT g/w	SIZE LxWmm	PACKAGE SIZE HxWxDmm	Quantity	JAN CODE
B-02BG	235	130x50	270x91x85	100	412459

WORK BELT B-01BG

Clip-style that's easy to attach or detach.



No.	WEIGHT g/w	SIZE LxWmm	PACKAGE SIZE HxWxDmm	Quantity	JAN CODE
B-01BG	150	120 (MAXIMUM) x50	252x91x53	100	412442

※The last six digits of JAN (Japanese Article Numbering) Code are displayed with the manufacturer code [4952520] omitted.

※The last six digits of JAN (Japanese Article Numbering) Code are displayed with the manufacturer code [4952520] omitted.

PLASTIC CUTTING NIPPERS

CATCH NIPPERS	24
PLASTIC CUTTING NIPPERS	24
PLASTIC CUTTING NIPPERS(MATERIAL:STAINLESS)	24
PLASTIC CUTTING NIPPERS	24
PLASTIC CUTTING NIPPERS(MATERIAL:STAINLESS)	25
PLASTIC CUTTING NIPPERS	25
MINITECH PLASTIC NIPPERS	25
PROTECH NIPPERS	26
END PLASTIC CUTTING NIPPERS	26
ANGLE PLASTIC CUTTING NIPPERS	26
PLASTIC CUTTING NIPPERS	27,28

CATCH NIPPERS 90CS-125,150



Cut piece is caught by two plates on the blades and is surely hold without missing, which makes workers efficiency better.



When cutting a cable tie, no fragments will scatter.

Items are inserted in-between two blades, successfully catching fragments. This prevents loss of fragments and has the possibility to increase worker efficiency.

No.	SIZE mm	WEIGHT g/w	CUTTING PERFORMANCE		SHATTERPROOF ABILITY mm	PACKAGE SIZE H×W×Dmm	Quantity	JAN CODE
			RESIN mm	SOFT RESIN mm				
90CS-125	125	85	Φ2.0	Φ0.8~2.0 (Cable tie:100~300mm)	170×73×17	6	009277	
90CS-150	150	135	Φ2.0	Φ0.8~2.0 (Cable tie:100~300mm)	200×73×18	6	009338	

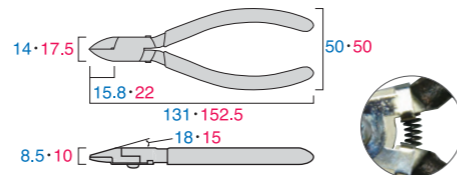

Hard resin

PLASTIC CUTTING NIPPERS HP940-125XF,150XF



A single-edge blade that cuts like it's slicing and reduces burrs on a cut cross section.



No.HP940-150XF

No.	SIZE mm	WEIGHT g/w	CUTTING PERFORMANCE		PACKAGE SIZE H×W×Dmm	Quantity	JAN CODE
			RESIN mm	SOFT RESIN mm			
HP940-125XF	125	90	Φ3.0	Φ3.0	170×73×14	6	009284
HP940-150XF	150	125	Φ5.0	Φ5.0	200×73×14	6	009291

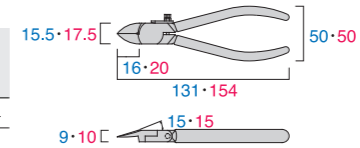

PLASTIC CUTTING NIPPERS HP940-125XR,150XR



A single-edge blade that cuts like it's slicing and reduces burrs on a cut cross section.



No.HP940-150XR

No.	SIZE mm	WEIGHT g/w	CUTTING PERFORMANCE		PACKAGE SIZE H×W×Dmm	Quantity	JAN CODE
			RESIN mm	SOFT RESIN mm			
HP940-125XR	125	90	Φ3.0	Φ3.0	170×73×14	6	009307
HP940-150XR	150	125	Φ5.0	Φ5.0	170×73×14	6	009314

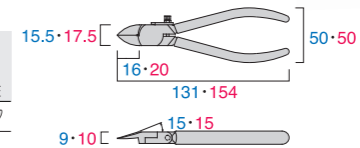

Soft resin

PLASTIC CUTTING NIPPERS(MATERIAL : STAINLESS) HP813-120X



With a sharp blade, this is suitable for cutting out pieces to go on a plastic model. It has a single-edge blade which leaves less burrs on a cut cross section and reduces whitening.



No.	SIZE mm	WEIGHT g/w	CUTTING PERFORMANCE		PACKAGE SIZE H×W×Dmm	Quantity	JAN CODE
			RESIN mm	SOFT RESIN mm			
HP813-120X	120	68	Φ3.0	Φ3.0	176×76×19	6	082492

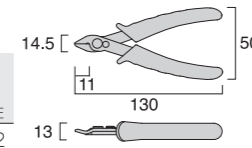

PLASTIC CUTTING NIPPERS HP925-125



Leaves a cleaner cut than regular plastic nippers, reduces frictional resistance on cut object, and allows for a simple, clean cut.

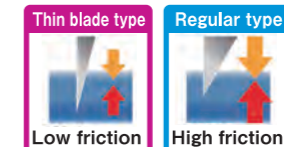

No.	SIZE mm	WEIGHT g/w	CUTTING PERFORMANCE		PACKAGE SIZE H×W×Dmm	Quantity	JAN CODE
			RESIN mm	SOFT RESIN mm			
HP925-125	125	90	Φ3.0	Φ3.0	170×73×15	6	009321

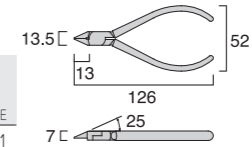

※The last six digits of JAN (Japanese Article Numbering) Code are displayed with the manufacturer code [4952520] omitted.

※The last six digits of JAN (Japanese Article Numbering) Code are displayed with the manufacturer code [4952520] omitted.

PLASTIC CUTTING NIPPERS (MATERIAL : STAINLESS)

HP845-125,150



Uses new grip which allows for long-time use while reducing burden on hand.

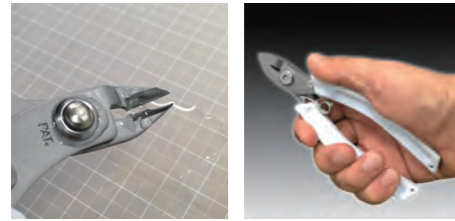

Water-resistant stainless steel

Easy-to-hold grips

No.	SIZE mm	WEIGHT g/w	CUTTING PERFORMANCE RESIN mm	PACKAGE SIZE H×W×Dmm	Quantity	JAN CODE
HP845-125	125	72	Φ3.0	200×73×14	6	082508
HP845-150	150	92	Φ5.0	200×73×14	6	082515

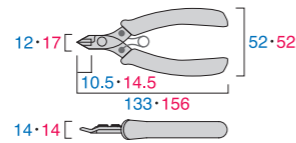

HP845-125

PLASTIC CUTTING NIPPERS

90PMA-150



Most suitable to cutting works in narrow and deep space because of super-fine shape of blades part.

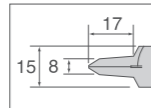

Special design allows for working in narrow spaces, too.

No.	SIZE mm	WEIGHT g/w	CUTTING PERFORMANCE RESIN mm	PACKAGE SIZE H×W×Dmm	Quantity	JAN CODE
90PMA-150	150	110	Φ2.0	200×73×14	6	009369

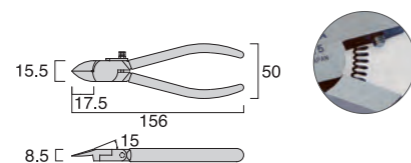

MINITECH PLASTIC NIPPERS

MP5-110



Small-type can fit in one's palm and is suitable for delicate work.



Excellent for using with plastic models and other cutting tasks due to its small head.

No.	SIZE mm	WEIGHT g/w	CUTTING PERFORMANCE RESIN mm	PACKAGE SIZE H×W×Dmm	Quantity	JAN CODE
MP5-110	110	60	Φ3.0	170×73×15	6	082447

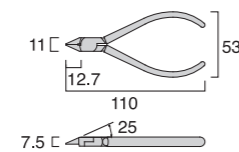

PROTECH NIPPERS

PP90-125,150



Suitable for cutting through soft resin (plastic).

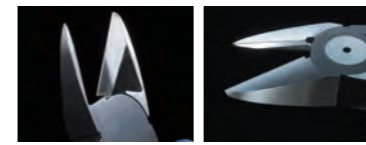

Blades part are processed by "Micro Mirror Blade", the leading edge of polishing technology developed by Fujiya, which achieve very keen blade and beautiful cut cross section.

No.	SIZE mm	WEIGHT g/w	CUTTING PERFORMANCE RESIN mm	PACKAGE SIZE H×W×Dmm	Quantity	JAN CODE
PP90-125	125	70	Φ3.0	170×73×17	6	083154
PP90-150	150	120	Φ5.0	200×73×17	6	083161

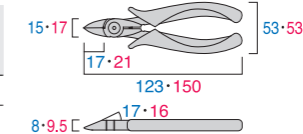

No.PP90-150

END PLASTIC CUTTING NIPPERS

910-125,150



The pointed nose comes with a blade inside which is excellent for dealing with deeper pin gates and the like.

Excellent for working with pin gates and submarine (tunnel) gates.

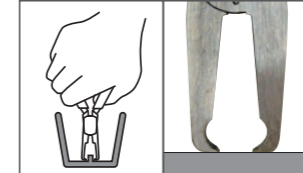

No.910-150

No.	SIZE mm	WEIGHT g/w	CUTTING PERFORMANCE RESIN mm	PACKAGE SIZE H×W×Dmm	Quantity	JAN CODE
910-125	125	70	Φ3.0	170×73×14	6	091005
910-150	150	100	Φ3.0	200×73×14	6	091012

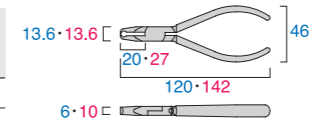

ANGLE PLASTIC CUTTING NIPPERS

920-125



The diagonal blade is beneficial for cutting in narrow spaces.

Excellent for working with pin gates and submarine (tunnel) gates.

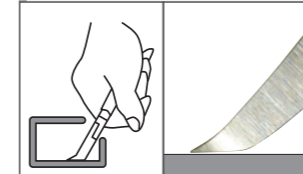

No.	SIZE mm	WEIGHT g/w	CUTTING PERFORMANCE RESIN mm	PACKAGE SIZE H×W×Dmm	Quantity	JAN CODE
920-125	125	70	Φ3.0	170×73×14	6	091029

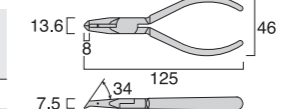

ANGLE PLASTIC CUTTING NIPPERS

50P-150



The diagonal blade is beneficial for cutting in narrow spaces.

Excellent for working with pin gates and submarine (tunnel) gates.

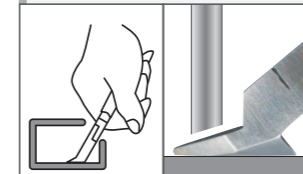

No.	SIZE mm	WEIGHT g/w	CUTTING PERFORMANCE RESIN mm	PACKAGE SIZE H×W×Dmm	Quantity	JAN CODE
50P-150	150	135	Φ5.0	200×73×20	6	005965

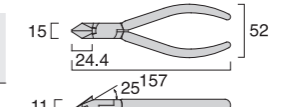

※The last six digits of JAN (Japanese Article Numbering) Code are displayed with the manufacturer code [4952520] omitted.

※The last six digits of JAN (Japanese Article Numbering) Code are displayed with the manufacturer code [4952520] omitted.

Straight blades Best for curved gate cuts.

PLASTIC CUTTING NIPPERS
GPN-125FS,150FS



These are the golden standard of nippers. It makes it harder for springs to drop.



No.GPN-150FS

No.	SIZE mm	WEIGHT g/w	CUTTING PERFORMANCE RESIN mm	PACKAGE SIZE HxWxDmm	Quantity	JAN CODE
GPN-125FS	125	90	Φ3.0	170×73×14	6	330333
GPN-150FS	150	125	Φ5.0	200×73×14	6	330340

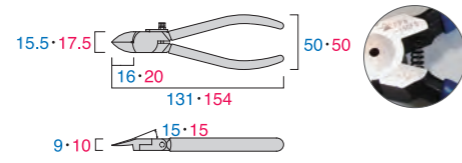

PLASTIC CUTTING NIPPERS
90A-150,175,200



*为部種面仕はNo.90A-175,200です。



No.90A-150

No.	SIZE mm	WEIGHT g/w	CUTTING PERFORMANCE RESIN mm	PACKAGE SIZE HxWxDmm	Quantity	JAN CODE
90A-150	150	140	Φ5.0	200×73×14	6	009154
90A-175	175	190	Φ6.0	223×73×17	6	009178
90A-200	200	270	Φ8.0	251×73×22	6	009185

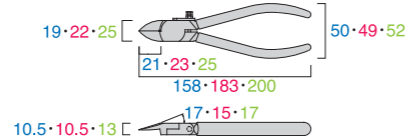

PLASTIC CUTTING NIPPERS
90AS-150,175,200

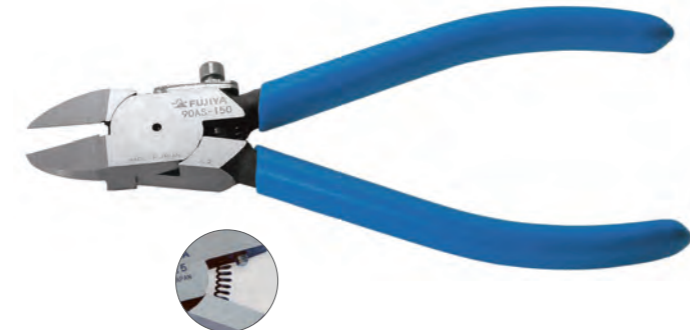

90AS-175,200

No.	SIZE mm	WEIGHT g/w	CUTTING PERFORMANCE RESIN mm	PACKAGE SIZE HxWxDmm	Quantity	JAN CODE
90AS-150	150	140	Φ5.0	200×73×14	6	009161
90AS-175	175	190	Φ6.0	223×73×17	6	009123
90AS-200	200	270	Φ8.0	251×73×22	6	009130

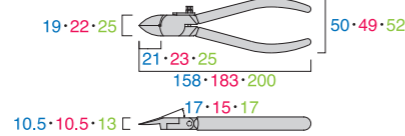

*The last six digits of JAN (Japanese Article Numbering) Code are displayed with the manufacturer code [4952520] omitted.

Round blades Suitable for flat gate cuts.

PLASTIC CUTTING NIPPERS
GPN-125RS,150RS



These are the golden standard of nippers. It makes it harder for springs to drop.



No.GPN-150RS

No.	SIZE mm	WEIGHT g/w	CUTTING PERFORMANCE RESIN mm	PACKAGE SIZE HxWxDmm	Quantity	JAN CODE
GPN-125RS	125	90	Φ3.0	170×73×14	6	330364
GPN-150RS	150	125	Φ5.0	200×73×14	6	330371

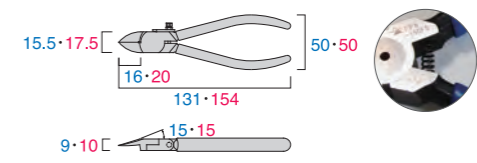

PLASTIC CUTTING NIPPERS
90-150,175



No.90-150

No.	SIZE mm	WEIGHT g/w	CUTTING PERFORMANCE RESIN mm	PACKAGE SIZE HxWxDmm	Quantity	JAN CODE
90-150	150	140	Φ5.0	200×73×14	6	009062
90-175	175	190	Φ6.0	223×73×17	6	009079

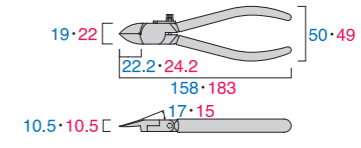

PLASTIC CUTTING NIPPERS
90S-110,125,150



*90S-150 only
**With stopper screw* and *Micro mirror blade finish* only 90S-150



This photo is only 90S-110

No.90S-150

No.	SIZE mm	WEIGHT g/w	CUTTING PERFORMANCE RESIN mm	PACKAGE SIZE HxWxDmm	Quantity	JAN CODE
90S-110	110	80	Φ3.0	170×73×14	6	009246
90S-125	125	90	Φ3.0	170×73×14	6	009253
90S-150	150	140	Φ5.0	200×73×14	6	009260

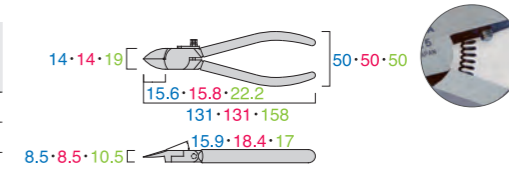

*The last six digits of JAN (Japanese Article Numbering) Code are displayed with the manufacturer code [4952520] omitted.

CUTTING NIPPERS

MICRO DIAGONAL CUTTING NIPPERS	29
PROTECH NIPPERS	30
STAINLESS STANDARD NIPPERS	30
MINITECH SMALL NIPPERS	30
MINITECH MINI NIPPERS	30
MINI NIPPERS	30
STANDARD NIPPERS	31
MINI NIPPERS	31
MINITECH BOARD NIPPERS	31
STRAIGHT NIPPERS	32
STRIPPING NIPPERS	32
ANGLE CUTTING NIPPERS	32
HEAVY DUTY STANDARD NIPPERS with CARBIDE BLADE	33
PROTECH NIPPERS with CARBIDE BLADE	33
STAINLESS STANDARD NIPPERS	29

MICRO DIAGONAL CUTTING NIPPERS FCN-05



Comes with "micro mirror blade." The high precision process gives these nippers excellent durability. Small blades make these excellent for working in narrow spaces.

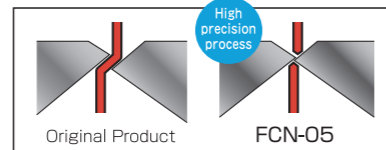

Blades part are processed by "Micro Mirror Blade", the leading edge of polishing technology developed by Fujiya, which achieve very keen blade and beautiful cut cross section.

With the introduction of cutting-edge machinery, these have an even greater machining accuracy. Even the most fine of cables are left with a clean cut.



No.	SIZE mm	WEIGHT g/w	CUTTING PERFORMANCE			PACKAGE SIZE HxWxDmm	Quantity	JAN CODE
			STEEL WIRE mm	COPPER WIRE mm	STRANDED WIRE mm			
FCN-05	125	70	Φ1.6	Φ0.15~2.0	Φ2.0	170×76×15	6	003077

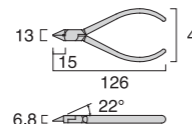

PROTECH NIPPERS PP60-125,150



Micro mirror blade model.



No.	SIZE mm	WEIGHT g/w	CUTTING PERFORMANCE		PACKAGE SIZE HxWxDmm	Quantity	JAN CODE
			STEEL WIRE mm	COPPER WIRE mm			
PP60-125	125	70	Φ1.2	Φ2.0	170×73×17	6	083055
PP60-150	150	120	Φ1.6	Φ2.6	200×73×17	6	083062

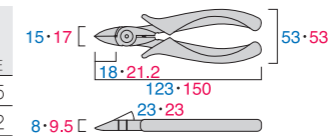

STAINLESS STANDARD NIPPERS HP855-125,150



Uses new grip which allows for long-time use while reducing burden on hand.



No.	SIZE mm	WEIGHT g/w	CUTTING PERFORMANCE		PACKAGE SIZE HxWxDmm	Quantity	JAN CODE
			STEEL WIRE mm	COPPER WIRE mm			
HP855-125	125	72	Φ1.2	Φ2.0	170×73×15	6	082522
HP855-150	150	92	Φ1.6	Φ2.6	200×73×15	6	082539

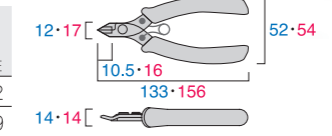

MINITECH SMALL NIPPERS GMN-110



Small-type can fit in one's palm and is suitable for delicate work.



No.	SIZE mm	WEIGHT g/w	CUTTING PERFORMANCE			PACKAGE SIZE HxWxDmm	Quantity	JAN CODE
			STEEL WIRE mm	COPPER WIRE mm	STANDARD WIRE mm			
GMN-110	110	60	Φ1.0	Φ1.8	Φ2.0	170×73×15	6	082348

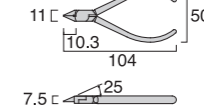

MINITECH MINI NIPPERS MP11-100



Excellent for dealing with very delicate cuts due to small, narrow blades.



No.	SIZE mm	WEIGHT g/w	CUTTING PERFORMANCE		PACKAGE SIZE HxWxDmm	Quantity	JAN CODE
			STEEL WIRE mm	COPPER WIRE mm			
MP11-100	100	40	Φ0.6	Φ1.0	170×73×15	6	080153

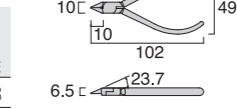

MINI NIPPERS FMN-125S



No.	SIZE mm	WEIGHT g/w	CUTTING PERFORMANCE		PACKAGE SIZE HxWxDmm	Quantity	JAN CODE
			STEEL WIRE mm	COPPER WIRE mm			
FMN-125S	125	70	Φ1.6	Φ2.0	170×73×15	6	003060

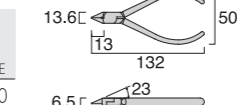

※The last six digits of JAN (Japanese Article Numbering) Code are displayed with the manufacturer code [4952520] omitted.

※The last six digits of JAN (Japanese Article Numbering) Code are displayed with the manufacturer code [4952520] omitted.

STANDARD NIPPERS

60-125,150



No.	SIZE mm	WEIGHT g/w	CUTTING PERFORMANCE		PACKAGE SIZE H×W×Dmm	Quantity	JAN CODE
			STEEL WIRE mm	COPPER WIRE mm			
60-125	125	85	Φ1.2	Φ2.0	170×73×15	6	006054
60-150	150	115	Φ1.6	Φ2.6	200×73×15	6	006061

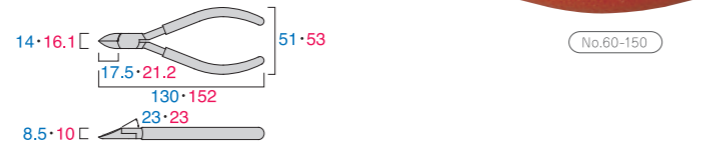

STANDARD NIPPERS

60S-125,150



No.	SIZE mm	WEIGHT g/w	CUTTING PERFORMANCE		PACKAGE SIZE H×W×Dmm	Quantity	JAN CODE
			STEEL WIRE mm	COPPER WIRE mm			
60S-125	125	80	Φ1.2	Φ2.0	170×73×15	6	006252
60S-150	150	120	Φ1.6	Φ2.6	200×73×15	6	006269

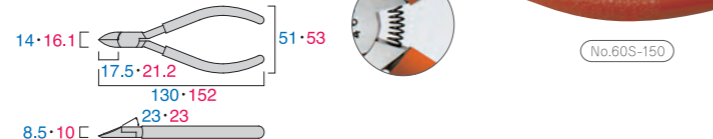

MINI NIPPERS

12S-120



Thin blade design that can easily cut through wire rods. Thin blade design makes these nippers suitable for cutting in narrow places.

No.	SIZE mm	WEIGHT g/w	CUTTING PERFORMANCE		PACKAGE SIZE H×W×Dmm	Quantity	JAN CODE
			STEEL WIRE mm	COPPER WIRE mm			
12S-120	120	75	Φ0.8	Φ1.2	170×73×15	6	001257

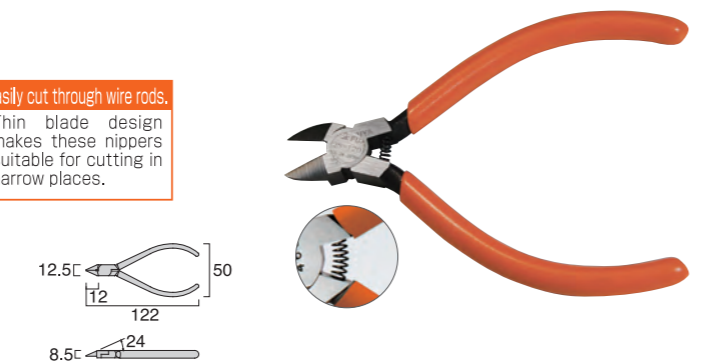

MINITECH BOARD NIPPERS

MTN03-135



Thin and light to reduce burden on hands. Excellent for cutting in narrow places.

No.	SIZE mm	WEIGHT g/w	CUTTING PERFORMANCE		PACKAGE SIZE H×W×Dmm	Quantity	JAN CODE
			STEEL WIRE mm	COPPER WIRE mm			
MTN03-135	135	65	Φ0.8	Φ1.3	200×73×17	6	080160

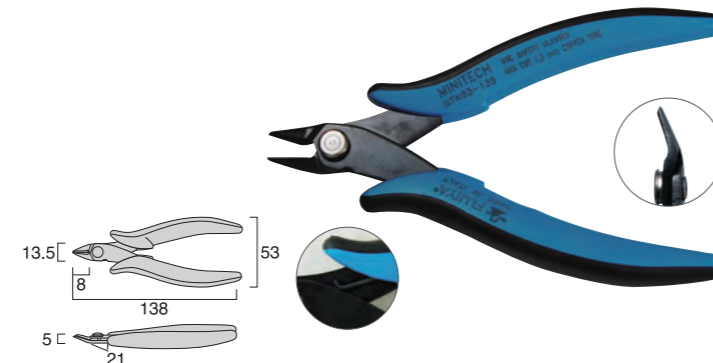

ELASTOMER Electro-static discharge model

MINITECH BOARD NIPPERS

MTN03E-135



Comes with an electrostatic discharge resistant resin grip for working with electronics, too.

No.	SIZE mm	WEIGHT g/w	CUTTING PERFORMANCE		PACKAGE SIZE H×W×Dmm	Quantity	JAN CODE
			STEEL WIRE mm	COPPER WIRE mm			
MTN03E-135	135	65	Φ0.8	Φ1.3	200×73×17	6	080177

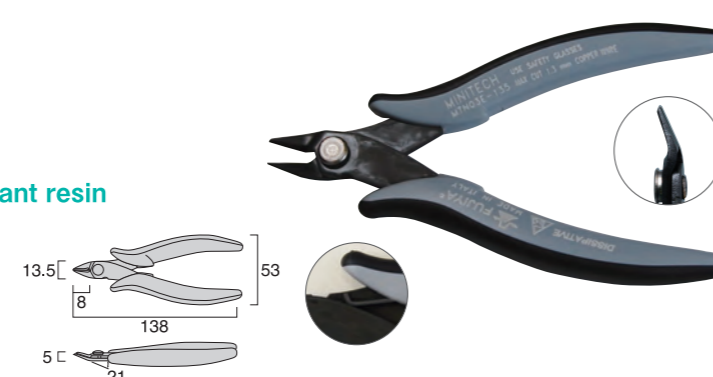

STRAIGHT NIPPERS

01-150



No.	SIZE mm	WEIGHT g/w	CUTTING PERFORMANCE		PACKAGE SIZE H×W×Dmm	Quantity	JAN CODE
			STEEL WIRE mm	COPPER WIRE mm			
01-150	150	120	Φ1.6	Φ2.6	200×73×15	6	000168



STRIPPING NIPPERS

10-125,150



Comes with stripping function for covered wires. Comes with stripping function for covered wires 0.8/1.5mmΦ.

No.	SIZE mm	WEIGHT g/w	CUTTING PERFORMANCE		PACKAGE SIZE H×W×Dmm	Quantity	JAN CODE
			STEEL WIRE mm	COPPER WIRE mm			
10-125	125	90	Φ1.2	Φ2.0	170×73×15	6	001059
10-150	150	110	Φ1.6	Φ2.6	200×73×15	6	001066



ANGLE CUTTING NIPPERS

50AP-100



No.	SIZE mm	WEIGHT g/w	CUTTING PERFORMANCE		PACKAGE SIZE H×W×Dmm	Quantity	JAN CODE
			STEEL WIRE mm	COPPER WIRE mm			
50AP-100	100	60	Φ1.0	Φ1.2	170×73×15	6	005040

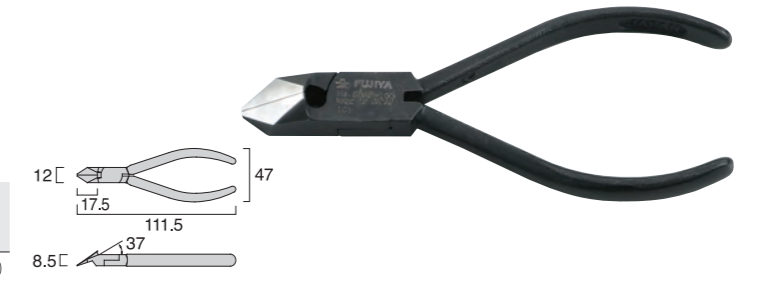

ANGLE CUTTING NIPPERS

50A-100,125,150,175



No.	SIZE mm	WEIGHT g/w	CUTTING PERFORMANCE		PACKAGE SIZE H×W×Dmm	Quantity	JAN CODE
			STEEL WIRE mm	COPPER WIRE mm			
50A-100	100	60	Φ1.0	Φ1.2	170×73×15	6	005033
50A-125	125	100	Φ1.2	Φ2.0	170×73×20	6	005057
50A-150	150	140	Φ1.2	Φ2.6	200×73×20	6	005064
50A-175	175	210	Φ1.5	Φ3.0	223×73×29	6	005071

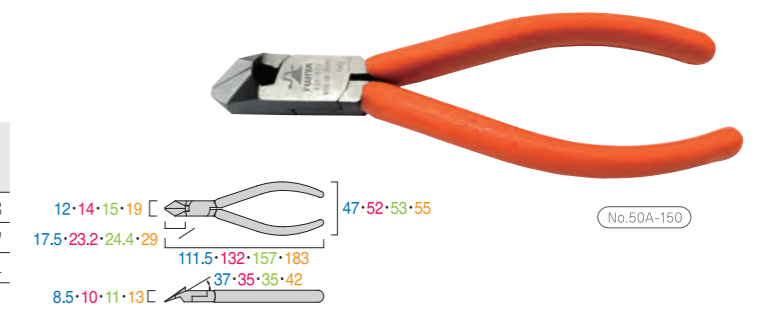

ANGLE CUTTING NIPPERS

GNN-150



Comes with stripping function for covered wires. Comes with stripping function for covered wires 0.8/1.5mmΦ.

No.	SIZE mm	WEIGHT g/w	CUTTING PERFORMANCE		PACKAGE SIZE H×W×Dmm	Quantity	JAN CODE
			STEEL WIRE mm	COPPER WIRE mm			
GNN-150	125	100	Φ1.2	Φ2.0	170×73×20	6	330418

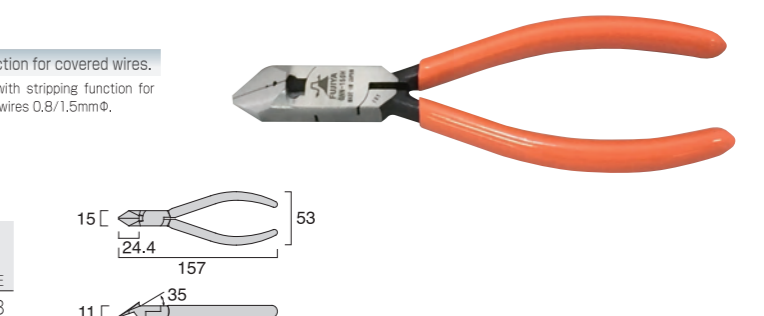

※The last six digits of JAN (Japanese Article Numbering) Code are displayed with the manufacturer code [4952520] omitted.

※The last six digits of JAN (Japanese Article Numbering) Code are displayed with the manufacturer code [4952520] omitted.

DIAGONAL CUTTING NIPPERS

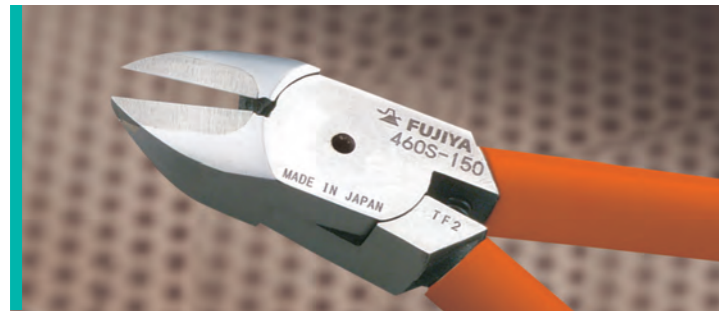

Able to cut piano wires with the carbide blade!

The blades have a carbide chip inserted in them leading to both superior cutting power and durability (three times more than the original product), and are excellent for cutting through piano and tungsten wires.

HEAVY DUTY STANDARD NIPPERS with CARBIDE BLADE 460S-125,150



Compared to regular nippers, the blades are much stronger.

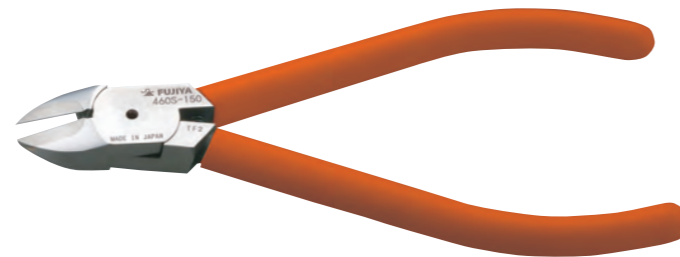

No.	SIZE mm	WEIGHT g/w	CUTTING PERFORMANCE			PACKAGE SIZE H×W×Dmm	Quantity	JAN CODE
			STEEL WIRE mm	COPPER WIRE mm	PIANO WIR mm			
460S-125	125	80	Φ1.2	Φ2.0	Φ0.5	170×73×15	6	046050
460S-150	150	120	Φ1.6	Φ2.6	Φ0.5	200×73×15	6	046067

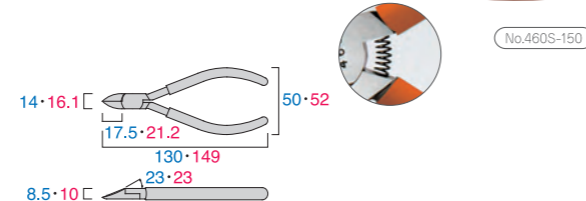

PROTECH NIPPERS with CARBIDE BLADE PP460-125,150



Compared to regular nippers, the blades are much stronger.



No.	SIZE mm	WEIGHT g/w	CUTTING PERFORMANCE			PACKAGE SIZE H×W×Dmm	Quantity	JAN CODE
			STEEL WIRE mm	COPPER WIRE mm	PIANO WIRE mm			
PP460-125	125	70	Φ1.2	Φ2.0	Φ0.3	170×73×17	6	083253
PP460-150	150	120	Φ1.6	Φ2.6	Φ0.5	200×73×17	6	083260

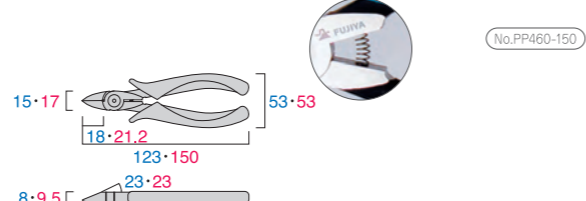

STAINLESS STANDARD NIPPERS 60H-150



Comes with rust-resistant, high-grade stainless steel!



Made with our internally developed high-grade stainless steel (SUS420J2). Made to be light, yet tough, these nippers have excellent durability and sharpness.

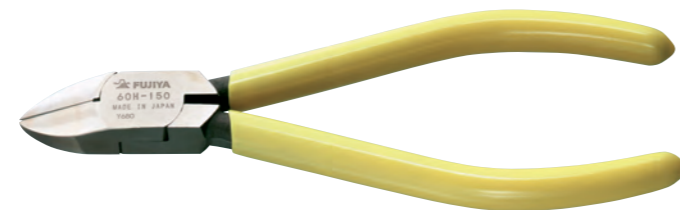

No.	SIZE mm	WEIGHT g/w	CUTTING PERFORMANCE		PACKAGE SIZE H×W×Dmm	Quantity	JAN CODE
			STEEL WIRE mm	COPPER WIRE mm			
60H-150	150	110	Φ0.8	Φ1.2	200×73×15	6	006368

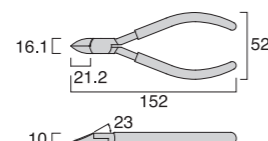

HIGH LEVERAGE DIAGONAL CUTTING NIPPERS	35
DIAGONAL CUTTING NIPPERS	36~38
HIGH LEVERAGE DIAGONAL CUTTING NIPPERS	37
HIGH POWER NIPPERS	37
ELECTRICAL WORK DIAGONAL CUTTING NIPPERS	38
HEAVY DUTY DIAGONAL CUTTING NIPPERS with CARBIDE BLADE	38



Diagonal cutting nippers

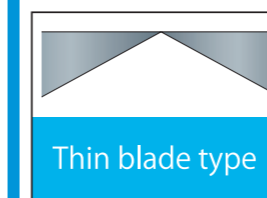

Suitable for cutting VVF (VA) cables.

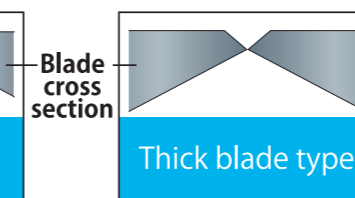

Suitable for cutting piano wires and soft steel wire.

Cutting materials					Please use the tools as indicated below.
RESIN	VVF CABLE	COPPER WIRE	SOFT STEEL WIRE	PIANO WIRE	
Thin blade type			Thick blade type		

※The last six digits of JAN (Japanese Article Numbering) Code are displayed with the manufacturer code [4952520] omitted.

MICRO MIRROR BLADE **Micro Mirror Blade**

Blades part are processed by "Micro Mirror Blade", the leading edge of polishing technology developed by Fujiya, which achieve very keen blade and beautiful cut cross section.

Regular type

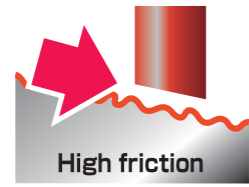

Micro Mirror Blade

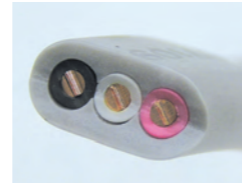
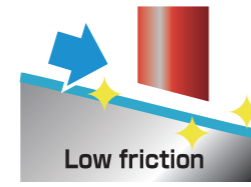
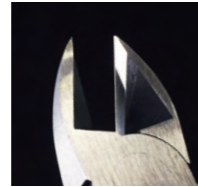

HIGH LEVERAGE DIAGONAL CUTTING NIPPERS

7700N-175,200



※Due to the blade being thin, these nippers will not cut through piano wire, spring wire, and wire cable.

These nippers are designed for VVF and VA cables with a Fujiya record-setting sharpness. They are diagonal and feature Fujiya's own "Micro Mirror Blade" developed through polishing technology.



No.7700N-175

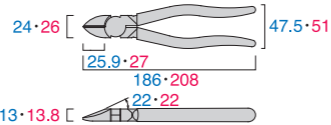

No.	SIZE mm	WEIGHT g/w	CUTTING PERFORMANCE			PACKAGE SIZE HxWxDmm	Quantity	JAN CODE
			COPPER WIRE mm	VA-VVF mm				
7700N-175	175	250	Φ3.5	Φ2.6×3core	223×73×20	6	077139	
7700N-200	200	320	Φ3.5	Φ2.6×3core	251×73×22	6	077146	

DIAGONAL CUTTING NIPPERS

770-150,175,200



※Due to the blade being thin, these nippers will not cut through piano wire, spring wire, and wire cable. ※Detachable

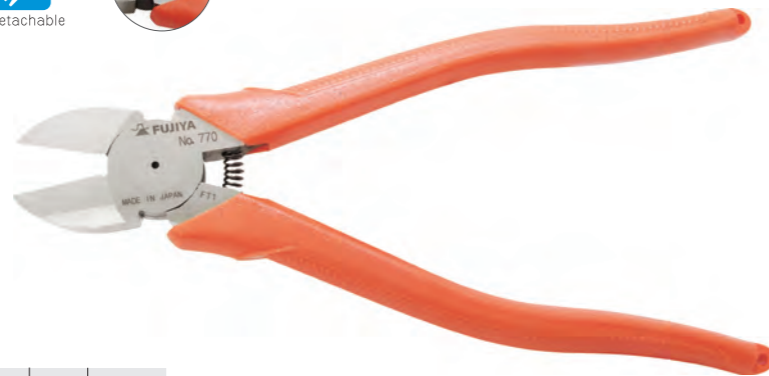

No.770-200

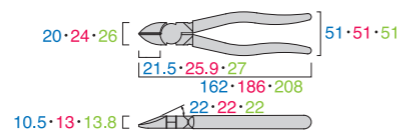

No.	SIZE mm	WEIGHT g/w	CUTTING PERFORMANCE			PACKAGE SIZE HxWxDmm	Quantity	JAN CODE
			STEEL WIRE mm	COPPER WIRE mm	VA-VVF mm			
770-150	150	170	Φ2.0	Φ3.0	Φ1.6×3core	200×73×15	6	077061
770-175	175	240	Φ2.0	Φ3.0	Φ2.0×3core	223×73×20	6	077078
770-200	200	320	Φ2.5	Φ3.5	Φ2.6×3core	251×73×22	6	077085

※The last six digits of JAN (Japanese Article Numbering) Code are displayed with the manufacturer code [4952520] omitted.

⚠ Do not use any of these products on anything that has an electrical current. There is a risk of electrical shock. ⚠ Be sure to thoroughly read the [Safety Warning] that is listed with each product's description.

DIAGONAL CUTTING NIPPERS

790-175,200



※Due to the blade being thin, these nippers will not cut through piano wire, spring wire, and wire cable.

The blade is thinner than the standard model and has a specialized cut.



No.790-200

No.	SIZE mm	WEIGHT g/w	CUTTING PERFORMANCE		PACKAGE SIZE HxWxDmm	Quantity	JAN CODE
			COPPER WIRE mm	VA-VVF mm			
790-175	175	240	Φ3.0	Φ2.0×3core	223×73×20	6	077153
790-200	200	310	Φ3.5	Φ2.6×3core	251×73×22	6	077160

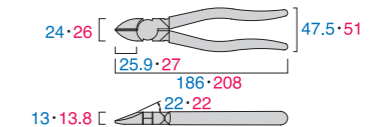

DIAGONAL CUTTING NIPPERS

77A-175,200/77R-175

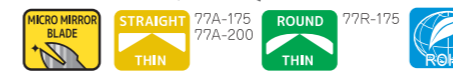

※Due to the blade being thin, these nippers will not cut through piano wire, spring wire, and wire cable.

This style is light and thin.

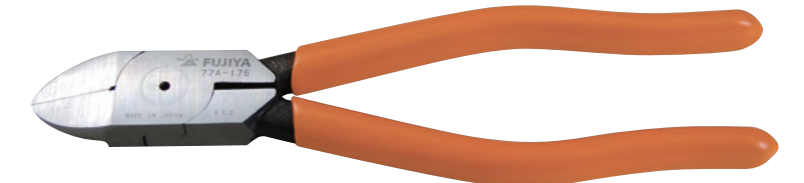

No.77A-175

No.	SIZE mm	WEIGHT g/w	CUTTING PERFORMANCE			PACKAGE SIZE HxWxDmm	Quantity	JAN CODE
			STEEL WIRE mm	COPPER WIRE mm	VA-VVF mm			
77A-175	175	200	Φ2.0	Φ3.0	Φ2.0×3core	223×73×17	6	007129
77A-200	200	270	Φ2.5	Φ3.5	Φ2.6×3core	251×73×22	6	007143
77R-175	175	200	Φ2.0	Φ3.0	Φ2.0×3core	223×73×17	6	007112

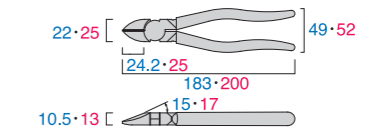

DIAGONAL CUTTING NIPPERS

707S-150



※Due to the blade being thin, these nippers will not cut through piano wire, spring wire, and wire cable.

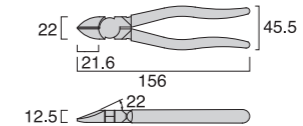

No.	SIZE mm	WEIGHT g/w	CUTTING PERFORMANCE		PACKAGE SIZE HxWxDmm	Quantity	JAN CODE
			STEEL WIRE mm	COPPER WIRE mm			
707S-150	150	170	Φ2.0	Φ3.0	200×73×15	6	070758

※The last six digits of JAN (Japanese Article Numbering) Code are displayed with the manufacturer code [4952520] omitted.

HIGH LEVERAGE DIAGONAL CUTTING NIPPERS

700N-175,200



Useable on a wide variety of items from piano wires and other hard wires, to VA cables.



No.700N-175

No.	SIZE mm	WEIGHT g/w	CUTTING PERFORMANCE			VA mm	PACKAGE SIZE HxWxDmm	Quantity	JAN CODE
			STEEL WIRE mm	COPPER WIRE mm	PIANO WIRE mm				
700N-175	175	270	Φ3.6	Φ4.0	Φ2.0	Φ1.6×3core	223×73×20	6	077092
700N-200	200	330	Φ4.0	Φ5.0	Φ2.5	Φ2.0×3core	251×73×22	6	077108

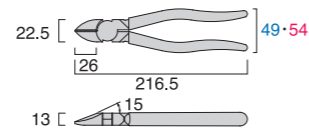

HIGH POWER NIPPERS

700-175,200



Size works with crimp terminal.1.25・2・5.5mm

Crimping function



No.700-200

No.	SIZE mm	WEIGHT g/w	CUTTING PERFORMANCE			PACKAGE SIZE HxWxDmm	Quantity	JAN CODE
			STEEL WIRE mm	COPPER WIRE mm	PIANO WIRE mm			
700-175	175	240	Φ2.2	Φ3.0	Φ1.2	223×73×20	6	070079
700-200	200	300	Φ3.0	Φ3.5	Φ1.2	251×73×22	6	070086

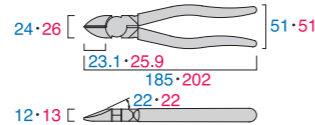

DIAGONAL CUTTING NIPPERS

7-200



No.	SIZE mm	WEIGHT g/w	CUTTING PERFORMANCE			PACKAGE SIZE HxWxDmm	Quantity	JAN CODE
			STEEL WIRE mm	COPPER WIRE mm	PIANO WIRE mm			
7-200	200	330	Φ2.5	Φ3.5	Φ1.2	251×73×22	6	000786

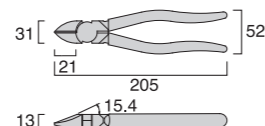

DIAGONAL CUTTING NIPPERS

70-125,150,175



*70-150,175only



No.70-150

No.	SIZE mm	WEIGHT g/w	CUTTING PERFORMANCE			PACKAGE SIZE HxWxDmm	Quantity	JAN CODE
			STEEL WIRE mm	COPPER WIRE mm	PIANO WIRE mm			
70-125	125	80	Φ1.2	Φ2.0	Φ0.3	170×73×15	6	007051
70-150	150	160	Φ2.0	Φ3.0	Φ1.0	200×73×15	6	007068
70-175	175	230	Φ2.0	Φ3.0	Φ1.2	223×73×20	6	007075

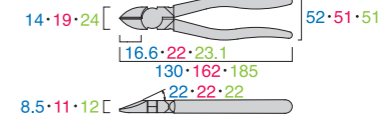

DIAGONAL CUTTING NIPPERS

GKN-150,175,200



A large, sturdy body.

*GKN-150only



No.70H-175

No.	SIZE mm	WEIGHT g/w	CUTTING PERFORMANCE			PACKAGE SIZE HxWxDmm	Quantity	JAN CODE
			STEEL WIRE mm	COPPER WIRE mm	PIANO WIRE mm			
GKN-150	150	190	Φ2.0	Φ3.0	Φ1.0	200×73×15	6	330326
GKN-175	175	240	Φ2.0	Φ3.0	Φ1.2	223×73×20	6	330425
GKN-200	200	320	Φ3.0	Φ3.5	Φ1.2	251×73×22	6	330432

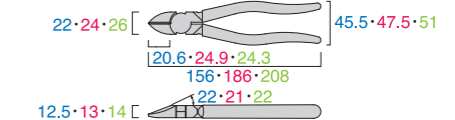

ELECTRICAL WORK DIAGONAL CUTTING NIPPERS

70Z-175



Composite Resin Cover

Made to withstand up to 1000V (AC). The interior layer is yellow, while the exterior is blue. When the yellow is visible, it indicates "danger".

*Note: These aren't insulated.



No.	SIZE mm	WEIGHT g/w	CUTTING PERFORMANCE			PACKAGE SIZE HxWxDmm	Quantity	JAN CODE
			STEEL WIRE mm	COPPER WIRE mm	PIANO WIRE mm			
70Z-175	175	260	Φ2.0	Φ3.0	Φ1.2	223×73×20	6	007679

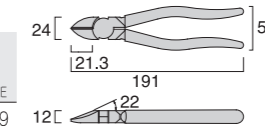

HEAVY DUTY DIAGONAL CUTTING NIPPERS with CARBIDE BLADE

470-150,175



Compared to regular nippers, the blades are much stronger.

The blades have a carbide chip inserted in them leading to both superior cutting power and durability (three times more than the original product), and are excellent for cutting through piano and tungsten wires.



No.470-150

No.	SIZE mm	WEIGHT g/w	CUTTING PERFORMANCE			PACKAGE SIZE HxWxDmm	Quantity	JAN CODE
			STEEL WIRE mm	COPPER WIRE mm	PIANO WIRE mm			
470-150	150	160	Φ2.0	Φ3.0	Φ1.2	200×73×15	6	047064
470-175	175	230	Φ2.0	Φ3.0	Φ1.2	223×73×20	6	047071

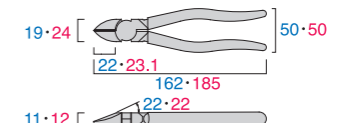

*The last six digits of JAN (Japanese Article Numbering) Code are displayed with the manufacturer code [4952520] omitted.

*The last six digits of JAN (Japanese Article Numbering) Code are displayed with the manufacturer code [4952520] omitted.

LONG NOSE PLIERS



- SCREW PLIERS 39
- SCREW PLIERS 40
- MECHANIC PLIERS STRAIGHT 40
- MECHANIC PLIERS ERGO GRIP 40
- LONG NOSE PLIERS 41
- BENT LONG NOSE PLIERS 41
- SIDE BENT LONG NOSE PLIERS 41
- MULTI-PURPOSE LONG NOSE PLIERS 41
- LONG NOSE PLIERS 42
- LONG FLAT NOSE PLIERS 42
- STAINLESS LONG NOSE PLIERS 42
- STAINLESS BENT NEEDLE NOSE PLIERS 42
- MINITECH SHORT NOSE PLIERS 43
- MINITECH BENT SHORT NOSE PLIERS 43
- MINITECH SUPER MICRO LONG NOSE PLIERS 43
- MINITECH TWEEZER LONG NOSE PLIERS 44
- TWEEZER LONG NOSE PLIERS 44

Easy to turn broken and special screw.
Possible to hold correctly even though rust and special screw and to exert removal and control of Screw powerfully.



For rusty screw For Stripped screw Wide ones also can be cut



Offers grip that goes in the direction of loosening the screw.

adaptive screw type		Adaptive screw size							
	Pan head screw	screw size	M2	M2.3	M2.5	M2.6	M3	M4	M5
	Head Diameter:	3.5	4	4.5	4.5	5.5	7	9	
	Truss head screw	screw size	M2	M2.3	M2.5	M2.6	M3	M4	
	Head Diameter:	4.5	-	5.7	-	6.9	9.4		

SCREW PLIERS NSP01-150



No.	SIZE mm	WEIGHT g/w	CUTTING PERFORMANCE		PACKAGE SIZE HxWxDmm	Quantity	JAN CODE
			STEEL WIRE mm	COPPER WIRE mm			
NSP01-150	150	180	Φ1.0	Φ1.5	200×73×15	6	002698

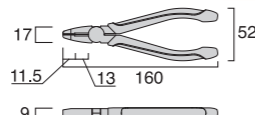

※The last six digits of JAN (Japanese Article Numbering) Code are displayed with the manufacturer code [4952520] omitted.

Easy to turn broken and special screw.
Possible to hold correctly even though rust and special screw and to exert removal and control of Screw powerfully.



For rusty screw For stripped screw

SCREW PLIERS SP26-175

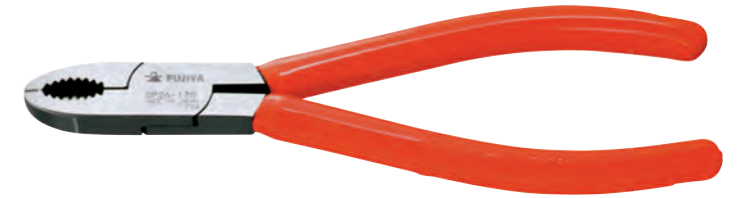
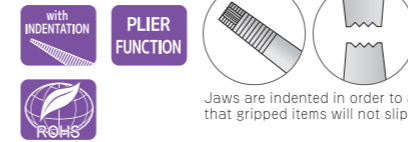

No.	SIZE mm	WEIGHT g/w	APPLICABLE SCREW SIZE	PACKAGE SIZE HxWxDmm	Quantity	JAN CODE
SP26-175	175	150	M2~M6	223×73×12	6	002674

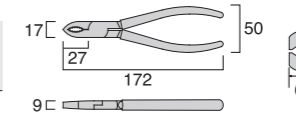

The grip is at a 40° curve, making it easier to see the nose.



No obstructions to one's view, making it easy to see what's being worked on.



Easily grippable



LONG NOSE PLIERS

MECHANIC PLIERS STRAIGHT 330-200



Stripping function Bolt cutting function (M3, M4) Crimping function (0.5~5.5mm²)



No.	SIZE mm	WEIGHT g/w	AWG	WIRE SIZE							PACKAGE SIZE HxWxDmm	Quantity	JAN CODE
				22	20	18	16	14	12	10			
330-200	215	190		0.3	0.5	0.9	1.3	2.0	3.5	5.5	280×80×16	10	032176

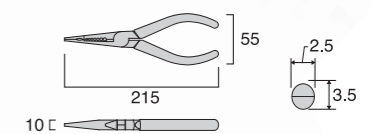

MECHANIC PLIERS ERGO GRIP 330E-200



Stripping function Bolt cutting function (M3, M4) Crimping function (0.5~5.5mm²)



No.	SIZE mm	WEIGHT g/w	AWG	WIRE SIZE					PACKAGE SIZE HxWxDmm	Quantity	JAN CODE
				20	18	16	14	12			
330E-200	185	186		0.5	0.9	1.3	2.0	3.5	255×98×16	10	032183

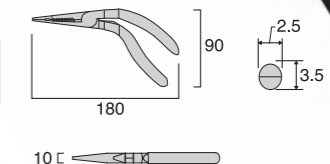

※The last six digits of JAN (Japanese Article Numbering) Code are displayed with the manufacturer code [4952520] omitted.

LONG NOSE PLIERS GR-125S,150S



No.	SIZE mm	WEIGHT g/w	CUTTING PERFORMANCE		PACKAGE SIZE HxWxDmm	Carton Box	JAN CODE
			STEEL WIRE mm	COPPER WIRE mm			
GR-125S	125	95	Φ1.5	Φ2.6	170×73×13	6	330388
GR-150S	150	120	Φ1.5	Φ2.6	200×73×15	6	330302

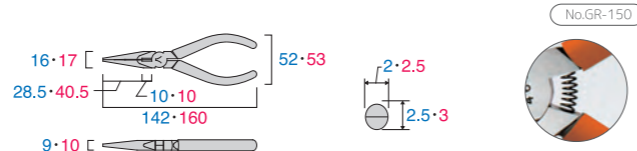

LONG NOSE PLIERS 350-125,150,200



No.	SIZE mm	WEIGHT g/w	CUTTING PERFORMANCE		PACKAGE SIZE HxWxDmm	Carton Box	JAN CODE
			STEEL WIRE mm	COPPER WIRE mm			
350-125	125	95	Φ1.5	Φ2.6	170×73×13	6	035054
350-150	150	120	Φ1.5	Φ2.6	200×73×15	6	035061
350-200	200	230	Φ2.0	Φ3.0	251×73×20	6	035085

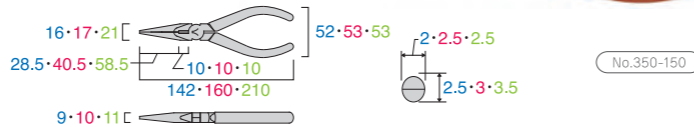

BENT LONG NOSE PLIERS 350T-150



No.	SIZE mm	WEIGHT g/w	CUTTING PERFORMANCE		PACKAGE SIZE HxWxDmm	Carton Box	JAN CODE
			STEEL WIRE mm	COPPER WIRE mm			
350T-150	150	120	Φ1.5	Φ2.6	170×73×15	6	035108

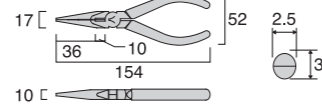

SIDE BENT LONG NOSE PLIERS 350Y-150

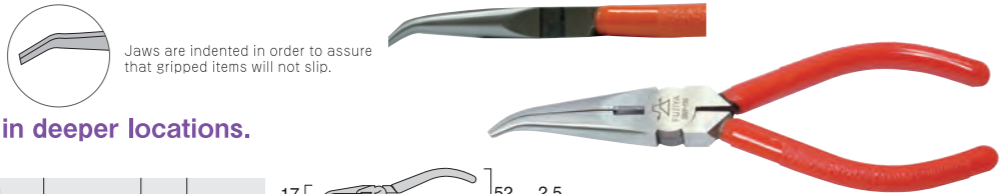

No.	SIZE mm	WEIGHT g/w	CUTTING PERFORMANCE		PACKAGE SIZE HxWxDmm	Carton Box	JAN CODE
			STEEL WIRE mm	COPPER WIRE mm			
350Y-150	150	120	Φ1.5	Φ2.6	200×73×15	6	035115

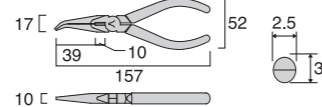

Six different functions are integrated into this single tool.

*1: Can crimp terminals up to 1.25mm ϕ .
 *2: Can strip vinyl wire where interior cable is up to 1.2mm in diameter.
 *3:

MULTI-PURPOSE LONG NOSE PLIERS GMR-150S



No.	SIZE mm	WEIGHT g/w	CUTTING PERFORMANCE		PACKAGE SIZE HxWxDmm	Carton Box	JAN CODE
			STEEL WIRE mm	COPPER WIRE mm			
GMR-150S	150	120	Φ1.5	Φ2.6	200×73×15	6	330319

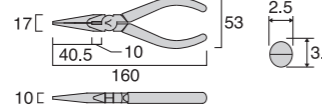

LONG NOSE PLIERS 380-170

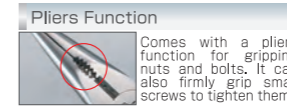

The nose is designed to be long and thin. Convenient when used to work in deeper locations, such as with precision machinery.

No.	SIZE mm	WEIGHT g/w	CUTTING PERFORMANCE		PACKAGE SIZE HxWxDmm	Carton Box	JAN CODE
			STEEL WIRE mm	COPPER WIRE mm			
380-170	170	110	Φ1.5	Φ2.6	223×73×16	6	038079

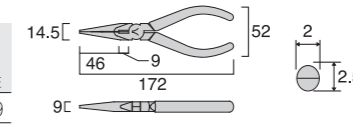

LONG FLAT NOSE PLIERS 360A-150

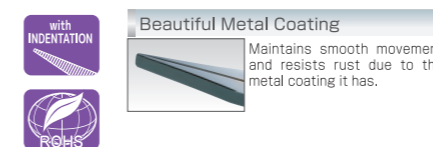

No.	SIZE mm	WEIGHT g/w	PACKAGE SIZE HxWxDmm	Carton Box	JAN CODE

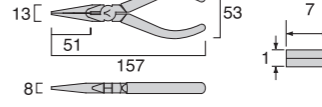

Made with stainless steel (SUS 420J2). The nose has a tough blade giving it exceptional durability in any holding work. The blade has superior cutting ability and durability.

STAINLESS LONG NOSE PLIERS 350H-150

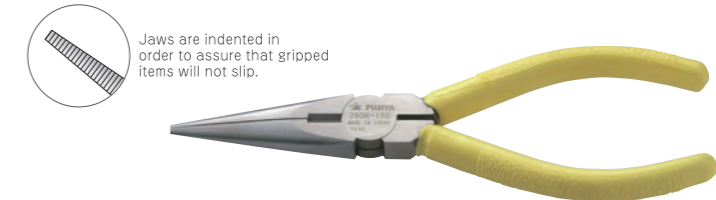
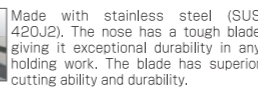

No.	SIZE mm	WEIGHT g/w	CUTTING PERFORMANCE		PACKAGE SIZE HxWxDmm	Carton Box	JAN CODE
			STEEL WIRE mm	COPPER WIRE mm			
350H-150	150	120	Φ1.2	Φ2.6	200×73×15	6	035368

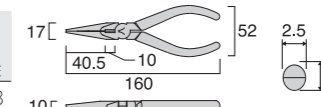

STAINLESS BENT NEEDLE NOSE PLIERS 350L-150

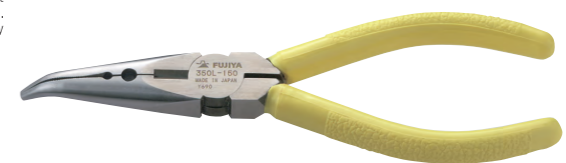
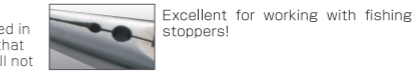
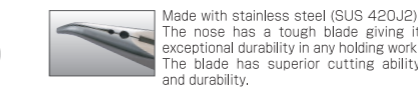

No.	SIZE mm	WEIGHT g/w	CUTTING PERFORMANCE		PACKAGE SIZE HxWxDmm	Carton Box	JAN CODE
			STEEL WIRE mm	COPPER WIRE mm			
350L-150	150	120	Φ1.2	Φ2.6	200×73×15	6	035467

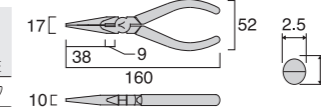

*The last six digits of JAN (Japanese Article Numbering) Code are displayed with the manufacturer code [4952520] omitted.

*The last six digits of JAN (Japanese Article Numbering) Code are displayed with the manufacturer code [4952520] omitted.



Minitch radio pliers are small, which makes them great for women and individuals with small hands who are working on making accessories. They can also be used with one's hobbies.

MINITECH SHORT NOSE PLIERS MP9-110



With a thin, short nose, these are excellent for precision work.

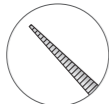

Jaws are indented in order to assure that gripped items will not slip.



No.	SIZE mm	WEIGHT g/w	CUTTING PERFORMANCE		PACKAGE SIZE HxWxDmm	Quantity	JAN CODE
			STEEL WIRE mm	COPPER WIRE mm			
MP9-110	110	57	Φ1.0	Φ1.5	170x73x12	6	033340

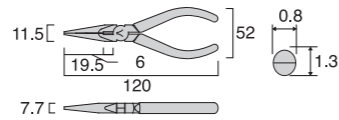

MINITECH SHORT NOSE PLIERS MP9A-110



Because the nose is thin and short, these are excellent for precision and gripping work.



Jaws are flat in order to not damage anything gripped.

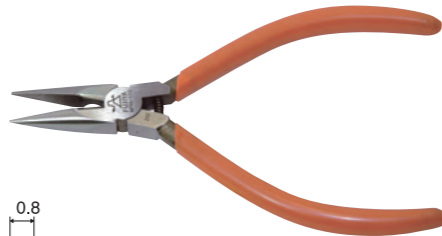

No.	SIZE mm	WEIGHT g/w	CUTTING PERFORMANCE		PACKAGE SIZE HxWxDmm	Quantity	JAN CODE
			STEEL WIRE mm	COPPER WIRE mm			
MP9A-110	110	57	Φ1.0	Φ1.5	170x73x12	6	033357

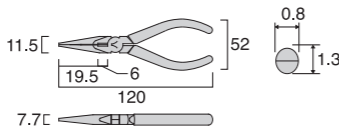

MINITECH BENT SHORT NOSE PLIERS MP9AT-110



Jaws are flat in order to not damage anything gripped.



No.	SIZE mm	WEIGHT g/w	CUTTING PERFORMANCE		PACKAGE SIZE HxWxDmm	Quantity	JAN CODE
			STEEL WIRE mm	COPPER WIRE mm			
MP9AT-110	110	57	Φ1.0	Φ1.5	170x73x12	6	033364

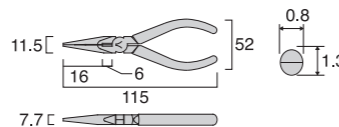

MINITECH SUPER MICRO LONG NOSE PLIERS MP6-150



These come with a tough blade which runs all the way to the nose and is difficult to bend.

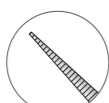

Jaws are indented in order to assure that gripped items will not slip.



No.	SIZE mm	WEIGHT g/w	CUTTING PERFORMANCE		PACKAGE SIZE HxWxDmm	Quantity	JAN CODE
			STEEL WIRE mm	COPPER WIRE mm			
MP6-150	150	100	Φ1.5	Φ2.6	200x73x15	6	302262

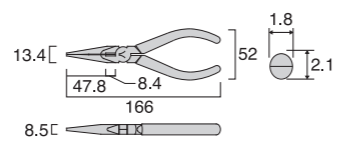

MINITECH TWEEZER LONG NOSE PLIERS MP7-150

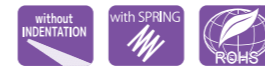

With a thin, short nose, these are excellent for precision work.



No.	SIZE mm	WEIGHT g/w	CUTTING PERFORMANCE		PACKAGE SIZE HxWxDmm	Quantity	JAN CODE
			STEEL WIRE mm	COPPER WIRE mm			
MP7-150	150	50	Φ0.8	Φ1.2	200x73x15	6	303269

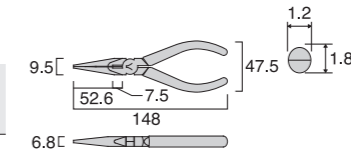

MINITECH TWEEZER LONG NOSE PLIERS MP8-150

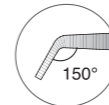
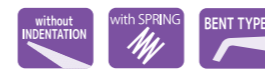

No.	SIZE mm	WEIGHT g/w	CUTTING PERFORMANCE		PACKAGE SIZE HxWxDmm	Quantity	JAN CODE
			STEEL WIRE mm	COPPER WIRE mm			
MP8-150	150	50	Φ0.8	Φ1.2	200x73x15	6	323267

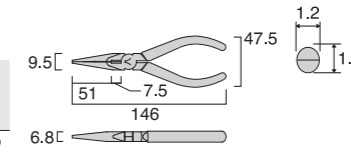

With Blade Type

When gripped, the blades touch, so force is dispersed.



Without Blade Type

When gripped, the blades do not touch, meaning that there is a perfect grip!

Perfect grip!

TWEEZER LONG NOSE PLIERS without Blade Type 303-150



No.	SIZE mm	WEIGHT g/w	PACKAGE SIZE HxWxDmm	Quantity	JAN CODE

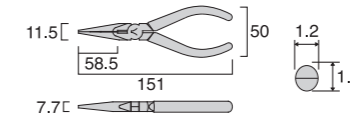

TWEEZER LONG NOSE PLIERS without Blade Type 303T-150

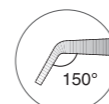

No.	SIZE mm	WEIGHT g/w	PACKAGE SIZE HxWxDmm	Quantity	JAN CODE

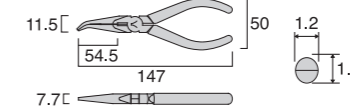

*The last six digits of JAN (Japanese Article Numbering) Code are displayed with the manufacturer code [4952520] omitted.

*The last six digits of JAN (Japanese Article Numbering) Code are displayed with the manufacturer code [4952520] omitted.

SIDE CUTTING PLIERS

HIGH LEVERAGE LINEMAN'S PLIERS "ZERO BLACK"	46
HIGH LEVERAGE LINEMAN'S PLIERS	46
HIGH LEVERAGE SIDE CUTTING PLIERS	47
HIGH LEVERAGE LINEMAN'S CRIMP PLIERS	47
ELECTRICAL WORK LINEMAN'S PLIERS	47
LINEMAN'S PLIERS	47
SIDE CUTTING PLIERS	48
ELECTRICAL WORK SIDE CUTTING PLIERS	48
LINEMAN'S CRIMP PLIERS	48



HIGH-LEVERAGE MECHANISM POWER UP!

High leverage type

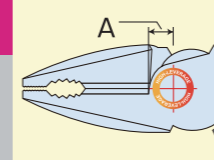

Having rivet placed closer to the cutting edges to provide more leverage.

Original Product

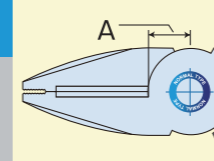

Rivet placed further to the cutting edges requires more force when cutting

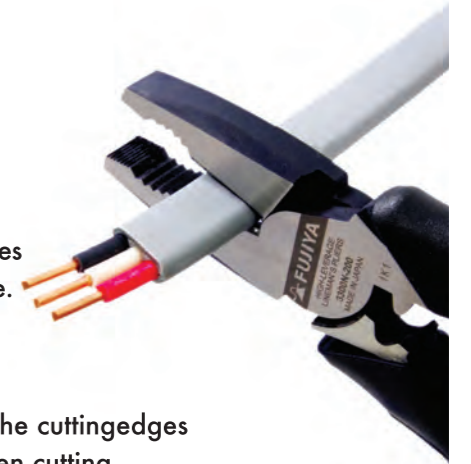

HIGH LEVERAGE LINEMAN'S PLIERS "ZERO BLACK" 3300N-200,225



Thin and light model



No.3300N-200

No.	SIZE mm	WEIGHT g/w	CUTTING PERFORMANCE				PACKAGE SIZE HxWxDmm	Quantity	JAN CODE
			STEEL WIRE mm	COPPER WIRE mm	PIANO WIRE mm	VA-VVF mm			
3300N-200	200	270	Φ3.4	Φ4.0	Φ1.6	Φ2.0×3core	253×73×20	6	030925
3300N-225	225	340	Φ3.6	Φ4.0	Φ2.0	Φ2.6×3core	270×73×20	6	030912

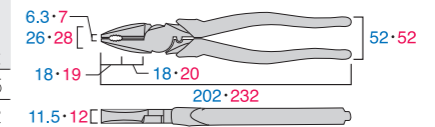

HIGH LEVERAGE LINEMAN'S PLIERS 3000TP-200,225



Thin and light model



No.3000TP-225

No.	SIZE mm	WEIGHT g/w	CUTTING PERFORMANCE				PACKAGE SIZE HxWxDmm	Quantity	JAN CODE
			STEEL WIRE mm	COPPER WIRE mm	PIANO WIRE mm	VA-VVF mm			
3000TP-200	200	270	Φ3.4	Φ4.0	Φ1.6	Φ2.0×3core	253×73×20	6	030745
3000TP-225	225	340	Φ3.6	Φ4.0	Φ2.0	Φ2.6×3core	270×73×20	6	030721

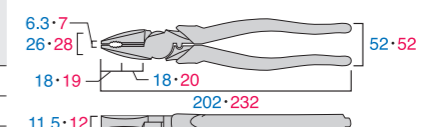

HIGH LEVERAGE LINEMAN'S PLIERS 3000SPT-225



Utilizes a diagonally cut nose allowing for both closing and removing cable clips.

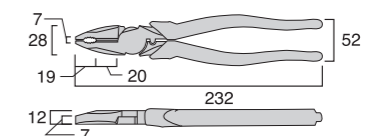

No.	SIZE mm	WEIGHT g/w	CUTTING PERFORMANCE				PACKAGE SIZE HxWxDmm	Quantity	JAN CODE
			STEEL WIRE mm	COPPER WIRE mm	PIANO WIRE mm	VA-VVF mm			
3000SPT-225	225	347	Φ3.6	Φ4.0	Φ2.0	Φ2.6×3core	270×73×35	6	030837

※The last six digits of JAN (Japanese Article Numbering) Code are displayed with the manufacturer code [4952520] omitted.

⚠ Do not use any of these products on anything that has an electrical current. There is a risk of electrical shock. ⚠ Be sure to thoroughly read the [Safety Warning] that is listed with each product's description.

CABLE HANDY CUTTERS SCISSORS

CABLE HANDY CUTTERS50
 ELECTRICAL WORK SCISSORS51
 PRO ELECTRICAL WORK SCISSORS51
 ELECTRICAL WORK SCISSORS51
 MINI AVIATION SNIPS51



CABLE HANDY CUTTERS GCC-150,200



No.	SIZE mm	WEIGHT g/w	CUTTING PERFORMANCE		PACKAGE SIZE HxWxDmm	Quantity	JAN CODE
			IV mm				
GCC-150	150	170	22mm ²	φ9.2	200×73×18	6	061008
GCC-200	200	320	38mm ²	φ11.4	251×73×15	6	061015

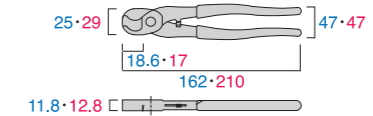

CABLE HANDY CUTTERS 600-240



No.	SIZE mm	WEIGHT g/w	CUTTING PERFORMANCE		PACKAGE SIZE HxWxDmm	Quantity	JAN CODE
			IV mm				
600-240	240	465	60mm ²	φ13.6	280×73×20	6	060100

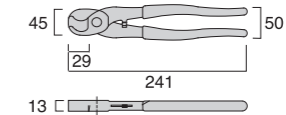

CABLE HANDY CUTTERS 600-500

ALUMINUM

Light thanks to its aluminum handles.



No.	SIZE mm	WEIGHT g/w	CUTTING PERFORMANCE		PACKAGE SIZE HxWxDmm	Quantity	JAN CODE
			IV mm	VVR mm			
600-500	500	1,030	250mm ²	100mm ²	570×140×30	6	060117

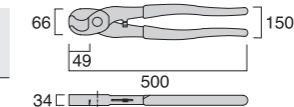

Easily cut through thick cables!

A dedicated tool for cutting through thick electrical cables during electrical work.

How to Speed Up the Blade or Release Partway Through

In the event that while cutting, the blade needs to be released, pull the stopper toward you to release.

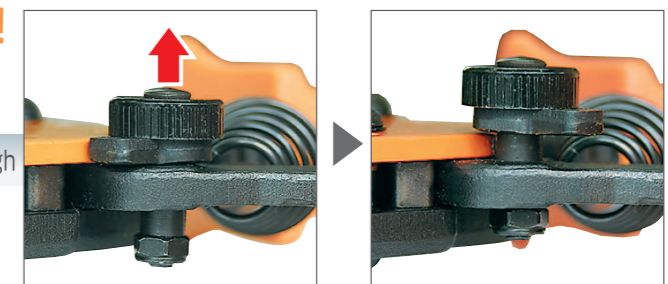





CABLE HANDY CUTTERS FRC-32A,45A

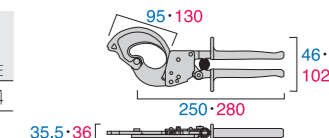

No.	SIZE mm	WEIGHT g/w	CUTTING PERFORMANCE					CUTTING PERFORMANCE CV 1CORE WIRE	PACKAGE SIZE HxWxDmm	Quantity	JAN CODE
			CV 1CORE WIRE mm	CV 3CORE WIRE mm	IV 1CORE WIRE mm	VVR 1CORE WIRE mm	VV 3CORE WIRE mm				
FRC-32A	260	610	250mm ²	60mm ² ×3core	325mm ²	325mm ²	50mm ² ×3core	325mm ²	360×117×35	6	060124
FRC-45A	300	800	400mm ²	100mm ² ×3core	500mm ²	500mm ²	100mm ² ×3core	500mm ²	415×140×35	6	060131

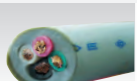

Types of cables and explanations.

VA·VVF Cable  2-core and 3-core coated cables which are primarily used in internal wiring within buildings.	IV Cable  A coated cable which is primarily used in internal wiring within buildings.	KIV Cable  The most common insulated cable used for internal wiring within buildings.
KIV Cable  Vinyl Cabtire Cable. Coated cable that comes with 2-cores, 3-cores, 4-cores, and more.	VVR Cable 3core  A coated cable which is primarily used in internal wiring within buildings.	CV Cable single core  A strengthened cable which has a polyethylene coating surrounding an electric cable.

*The last six digits of JAN (Japanese Article Numbering) Code are displayed with the manufacturer code [4952520] omitted.

⚠ Do not use any of these products on anything that has an electrical current. There is a risk of electrical shock. ⚠ Be sure to thoroughly read the [Safety Warning] that is listed with each product's description.

ALMIGHTY ELECTRICAL WORK SCISSORS

FM02-200

- STANDARD MODEL
- with SPRING
- STOPPER FUNCTION
- Able to cut through wiring molding, too!



No.	SIZE mm	WEIGHT g/w	CUTTING PERFORMANCE			PACKAGE SIZE HxWxDmm	Quantity	JAN CODE
			RESIN mm	VA-VVF mm	VCT mm			
FM02-200	200	155	Φ20			265×80×20	6	002087

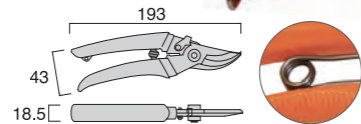

ELECTRICAL WORK SCISSORS

FM03-180

- with SPRING
- ELASTOMER
- SAFETY
- STOPPER FUNCTION
- ROHS



No.	SIZE mm	WEIGHT g/w	CUTTING PERFORMANCE			PACKAGE SIZE HxWxDmm	Quantity	JAN CODE
			RESIN mm	VA-VVF mm	VCT mm			
FM03-180	180	120	Φ20	Φ2.0×3core	Φ3.0×5.5mm ²	234×73×20	6	002094

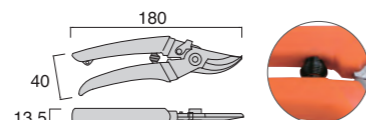

ELECTRICAL WORK SCISSORS

FM04-180N

- with SPRING
- STOPPER FUNCTION
- ROHS
- Excellent for when needing to cut through a wide variety of items, such as cables and papers, in the course of electrical work.



No.	SIZE mm	WEIGHT g/w	CUTTING PERFORMANCE			STEEL PLATE mm	PACKAGE SIZE HxWxDmm	Quantity	JAN CODE
			RESIN mm	VA-VVF mm	VCT mm				
FM04-180N	180	108	Φ20	Φ2.0×3core	Φ3.0×5.5mm ²	0.5	245×70×20	6	002247

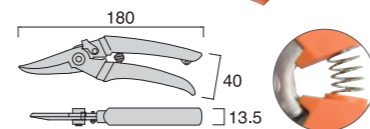

From electrical work involving cutting through VA and VFF cables, to cutting through wiring covers (molding), other resin materials, and rubber cable wires, these cutters are excellent.

Able to cut through wires, as well.

ELECTRICAL WORK SCISSORS

FM06-210

- with SPRING
- SAFETY
- STOPPER FUNCTION
- MICRO EDGE
- STAINLESS



No.	SIZE mm	WEIGHT g/w	CUTTING PERFORMANCE			PACKAGE SIZE HxWxDmm	Quantity	JAN CODE
			VCT mm	VA-VVF mm	SOFT RESIN mm			
FM06-210	210	175	Φ3.0×5.5mm ²	Φ2.0×3core	Φ20	251×73×20	6	002124

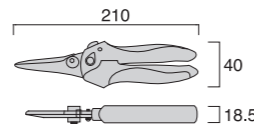

- Able to cut through wires, as well.
- The high precision process allows these to cut through fabric and paper, too.
- The lever mechanism makes for an easier time cutting.

Comes with a quick open function.



Grip and open to release the lock.

MINI AVIATION SNIPS

BKB-180M, 180MR, 180ML

- with SPRING
- STOPPER FUNCTION



No.	SIZE mm	WEIGHT g/w	CUTTING PERFORMANCE			PACKAGE SIZE HxWxDmm	Quantity	JAN CODE
			COPPER PLATE mm	STEEL PLATE mm	STAINLESS PLATE mm			
BKB-180M	180	185	1.5	1.2	0.7	250×88×28	6	002308
BKB-180MR	180	185	1.5	1.2	0.7	250×88×28	6	002315
BKB-180ML	180	185	1.5	1.2	0.7	250×88×28	6	002322



※The last six digits of JAN (Japanese Article Numbering) Code are displayed with the manufacturer code [4952520] omitted.

ADJUSTABLE WRENCH PLIERS

- ADJUSTABLE WRENCH53
- ADJUSTABLE WRENCH SHORT TYPE54
- ADJUSTABLE WRENCH STANDARD TYPE54
- SNAP RING PLIERS EXTERENAL OPEN (STRAIGHT)54
- SNAP RING PLIERS INTERNAL CLOSE (STRAIGHT)54

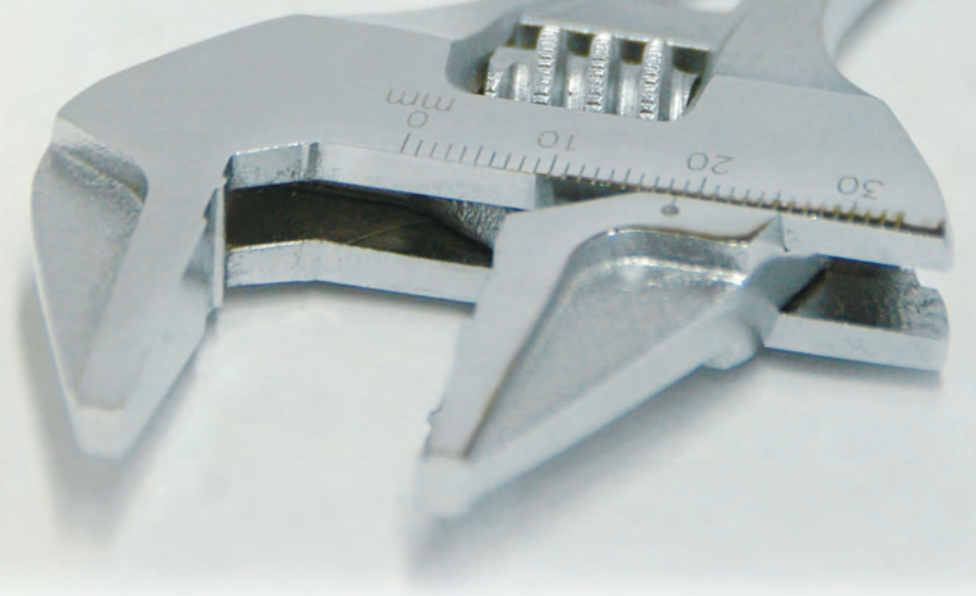

A thin and light model. Compact, and easy to use in narrow spaces. Boasts a strength which is powerful enough to have cleared the Strength Class of the Japanese Industrial Standards.

Open wide jaw

Opens 10% more than a standard JIS approved model.



Close end the last

Handy when dealing with small nuts and bolts.



Thin and long jaw

The teeth are thin and long, making it easy to reach narrow spaces.



Hard to get broken

The teeth have a special design so as to not damage nuts and bolts.

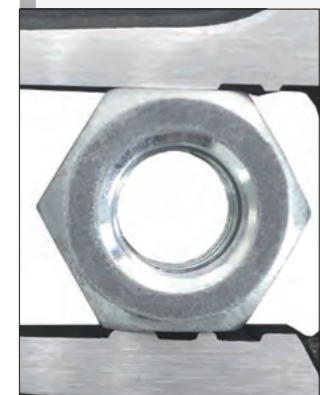

※The last six digits of JAN (Japanese Article Numbering) Code are displayed with the manufacturer code [4952520] omitted.

ADJUSTABLE WRENCH

FLA-28-F, FLA-32-F
FLA-43-F, FLA-53-F



The teeth have a special design so as to not damage nuts and bolts. Its design is light and thin, however it's powerful enough to have cleared the Strength Class of the Japanese Industrial Standards.



Convenient multipurpose head

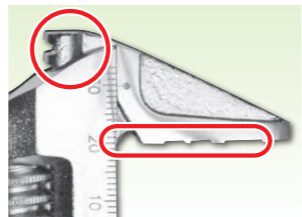

Has a distinctive design to prevent damaging nuts and bolts. It has few protrusions making it easy to use in narrow spaces.

No.	SIZE mm	MAXIMUM OPENING mm	WEIGHT g/w	Quantity	JAN CODE
FLA-28-F	155	0~28	114	6	852002
FLA-32-F	205	0~32	191	6	852019
FLA-43-F	256	0~43	277	6	852026
FLA-53-F	306	0~53	490	6	852033

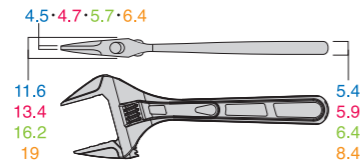

ADJUSTABLE WRENCH

FLA-32G-F, FLA-43G-F



Comes with a specially dipped grip that makes it harder to lose one's grip.

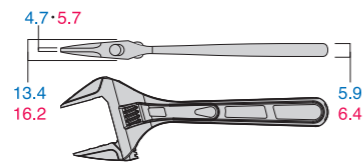

No.	SIZE mm	MAXIMUM OPENING mm	WEIGHT g/w	Quantity	JAN CODE
FLA-32G-F	205	0~32	191	6	852095
FLA-43G-F	256	0~43	277	6	852101

ADJUSTABLE WRENCH SHORT TYPE

FLS-28G-F, FLS-32G-F, FLS-43G-F, FLS-53G-F



A short grip type that's perfectly portable and storable.

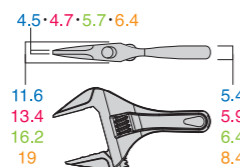

No.	SIZE mm	MAXIMUM OPENING mm	WEIGHT g/w	Quantity	JAN CODE
FLS-28G-F	118	0~28	103	6	852040
FLS-32G-F	139	0~32	154	6	852057
FLS-43G-F	156	0~43	235	6	852064
FLS-53G-F	185	0~53	398	6	852071

ADJUSTABLE WRENCH <STANDARD TYPE>

FAW-100-17, 150-24, 200-28, 250-32, 300-38, 375-50, 450-60, 600-70



15 degree-type for easily working in narrow spaces

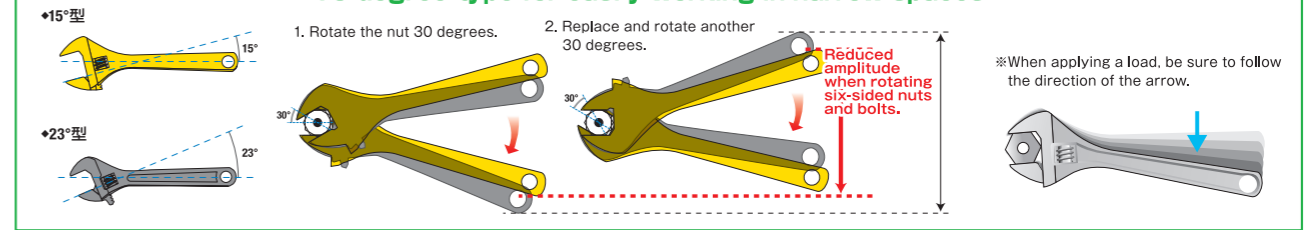

Opens 10% wider than a standard JIS approved model, meaning that this can handle even larger bolts and nuts.

No.	SIZE mm	WEIGHT g/w	MAXIMUM OPENING mm	SIZE mm			Quantity	JAN CODE
				A	B	L		
FAW-100-17	100	55	0~17	6.4	9.5	109	68	852125
FAW-150-24	150	141	0~24	7.1	11.6	159	12	852132
FAW-200-28	200	258	0~28	8.7	14.6	206	12	852149
FAW-250-32	250	468	0~32	11.1	16.9	257	12	852156
FAW-300-38	300	700	0~38	13.5	20.4	308	6	852163
FAW-375-50	375	1250	0~50	15.8	25.4	386	4	852170
FAW-450-60	450	1920	0~60	18.2	30.9	463	1	852187
FAW-600-70	600	3020	0~70	23	36.5	615	1	852194

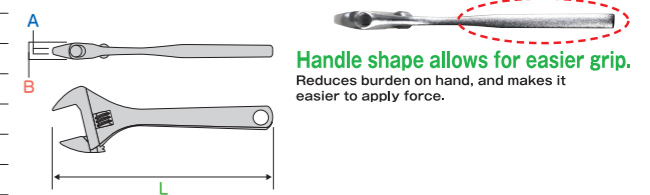
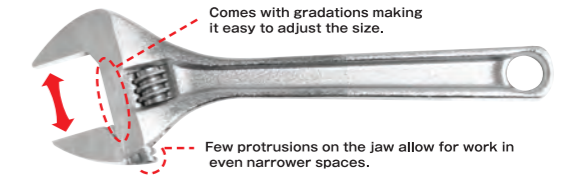

SNAP RING PLIERS EXTERNAL OPEN (STRAIGHT)

FOS-185

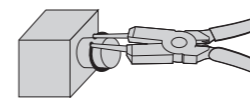

Useable size of ring. 10~40mm



No.	SIZE mm	WEIGHT g/w	DIAMETER OF THE TIP mm	RING SIZE mm	PACKAGE SIZE HxWxDmm	Quantity	JAN CODE
FOS-185	185	175	2.0	10~40	223x73x20	6	040027

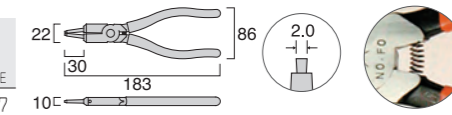

SNAP RING PLIERS INTERNAL CLOSE (STRAIGHT)

FCS-185

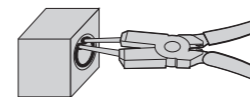

Useable size of ring. 12~65mm



No.	SIZE mm	WEIGHT g/w	DIAMETER OF THE TIP mm	RING SIZE mm	PACKAGE SIZE HxWxDmm	Quantity	JAN CODE
FCS-185	185	175	2.0	12~65	223x73x20	6	040034

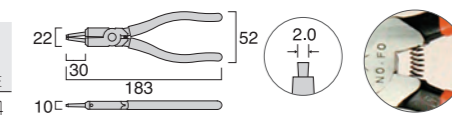

SNAP RING PLIERS Detachable claw

No.	PACKAGE SIZE HxWxDmm	Quantity	JAN CODE
FB-1	97x40x5	-	040119
FS-1	97x40x5	-	040126
FS-L1	97x40x5	-	040133
FS-L2	97x40x5	-	040140

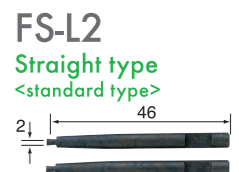
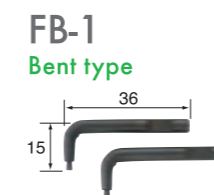

*The last six digits of JAN (Japanese Article Numbering) Code are displayed with the manufacturer code [4952520] omitted.

*The last six digits of JAN (Japanese Article Numbering) Code are displayed with the manufacturer code [4952520] omitted.

LINEMAN'S TOOLS

CRIMPING PLIERS(for Insulated Terminals · Non-Insulated Terminals) ... 55	MODULAR PLUG ATTACHING/DETACHING TOOL ... 57	C-CHANNEL CUTTERS ... 60
CRIMPING PLIERS(for Faston Terminal) ... 55	CRIMPING PLIERS ... 58	ELECTRICAL PENETRATION HAMMER ... 60
AUTO MULTI STRIPPER ... 56	TOOL KIT ... 59	VINYL PIPE CUTTER ... 61
PROTECH WIRE STRIPPER ... 56	VA CABLE STRIPPERS ... 59	RESIN FLEXIBLE CUTTER ... 61
WIRE STRIPPER ... 57	ELECTRICAL WORK VA STRIPPER ... 59	RESIN TUBE CUTTER ... 61
AUTO MULTI STRIPPER ... 57	ELECTRICAL WORK KNIFE ... 59	6-PC.PRECISION SCREWDRIVER SET ... 61
MODULAR PLUG ATTACHING/DETACHING TOOL ... 57	M-BAR CUTTERS ... 60	ELECTRIC TEST DRIVER (-) 100-380V ... 61

AUTO MULTI STRIPPER PP707A-200



suitable for wiring work such as for a machine, a car, an appliance, etc. easy to strip the wire without worrying about the thickness.



Please scan this QR code for more information about the Auto Multi Stripper.



Able to easily handle stripping wires while laying down wiring. Cable Cutting Feature Included.

No.	SIZE mm	WEIGHT g/w	WIRE SIZE	PACKAGE SIZE H×W×Dmm	Quantity	JAN CODE
PP707A-200	200	340	0.13~6mm ²	260×100×40	6	083536

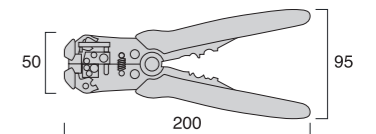

Condensed functions in a more compact body!
2/3rds the Size **1/2** the Weight

CRIMPING for Faston/Insulated, Non-Insulated terminals

WIRE CUTTING

WIRE STRIPPING

*Compared with original products offered by our company.

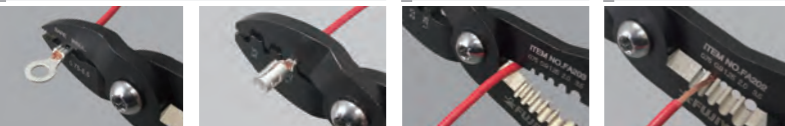

CRIMPING PLIERS(for Insulated Terminals · Non-Insulated Terminals) FA202



No.	SIZE mm	WEIGHT g/w	CRIMPING TERMINAL CAPACITY	AWG	WIRE SIZE					PACKAGE SIZE H×W×Dmm	Quantity	JAN CODE
					Cross section (mm ²)	18	17	16	14			
FA202	175	158	1.25/2.0/5.5	AWG	0.75	0.9	1.25	2.0	3.5	230×80×16	10	067307

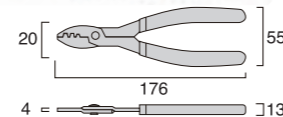

CRIMPING PLIERS(for Faston Terminal) FA203



No.	SIZE mm	WEIGHT g/w	CRIMPING TERMINAL CAPACITY	AWG	WIRE SIZE					PACKAGE SIZE H×W×Dmm	Quantity	JAN CODE
					Cross section (mm ²)	18	17	16	14			
FA203	180	164	1.25/2.0/5.5	AWG	0.75	0.9	1.25	2.0	3.5	230×80×16	10	067314

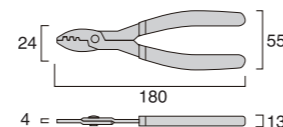

PROTECH WIRE STRIPPER Type A PP323A-165



AWG or mm is displayed on the tool. The cable can be separated by a highly precise surface polishing blade. Even if gripped firmly, the tool has a soft molding resin grip in order to reduce burden on hand.



No.	SIZE mm	WEIGHT g/w	WIRE SIZE (Stranded)						PACKAGE SIZE H×W×Dmm	Quantity	JAN CODE	
			AWG	20	18	16	14	12				10
PP323A-165	164	140	Cross section (mm ²)	0.5	0.8	1.3	2.0	3.3	5.3	215×95×25	10	083390
			SQ SIZE	0.5	0.75	1.25	2.0	3.5	5.5			

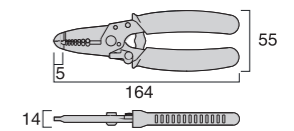

PROTECH WIRE STRIPPER Type B PP323B-165



AWG or mm is displayed on the tool. The cable can be separated by a highly precise surface polishing blade. Even if gripped firmly, the tool has a soft molding resin grip in order to reduce burden on hand.



No.	SIZE mm	WEIGHT g/w	WIRE SIZE (Stranded)									PACKAGE SIZE H×W×Dmm	Quantity	JAN CODE
			AWG	30	28	26	24	22	20	18	16			
PP323B-165	164	140	Cross section (mm ²)	0.05	0.08	0.12	0.2	0.3	0.5	0.8	1.3	215×95×25	10	083406
			SQ SIZE	0.05	0.08	0.12	0.2	0.3	0.5	0.75	1.25			

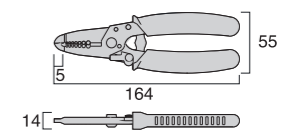

*The last six digits of JAN (Japanese Article Numbering) Code are displayed with the manufacturer code [4952520] omitted.

*The last six digits of JAN (Japanese Article Numbering) Code are displayed with the manufacturer code [4952520] omitted.

WIRE STRIPPER (For a single cable-A·For a single cable-B·IV CABLE-C)

PP404-180A, PP404-180B, PP404-180C

with SPRING CUTTER DETACHABLE BLADE A highly precise surface blade will not damage the core cable.

Interchangeable Blade Options

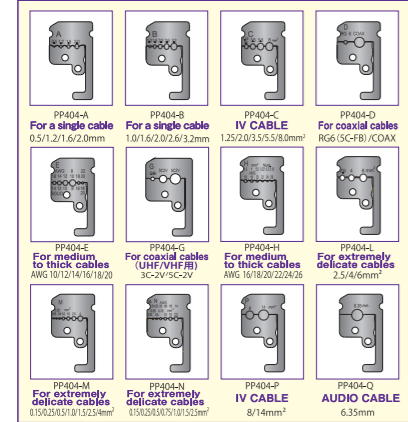

Comes with cable cutter function

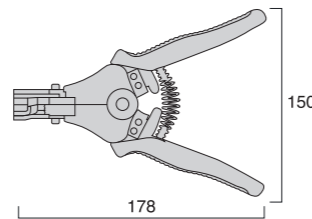

No.	SIZE mm	WEIGHT g/w	WIRE SIZE (mm ²)	PACKAGE SIZE H×W×Dmm	Quantity	JAN CODE
PP404-180A	180	400	0.5/1.2/1.6/2.0	245×118×35	8	083901
PP404-180B	180	400	1.0/1.6/2.0/2.6/3.2	245×118×35	8	083918
PP404-180C	180	400	1.25/2.0/3.5/5.5/8.0	245×118×35	8	083925

AUTO MULTI STRIPPER Mini

PP505-170

CUTTER STOPPER FUNCTION Excellent for laying wiring in narrow spaces.



Comes with cable cutter function

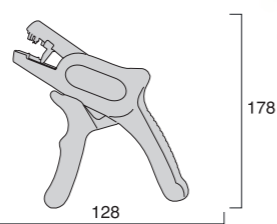

No.	SIZE mm	WEIGHT g/w	WIRE SIZE		PACKAGE SIZE H×W×Dmm	Quantity	JAN CODE
			AWG	Cross section (mm ²)			
PP505-170	170	130	10~24	0.2~6	261×130×25	10	084106
			SQ SIZE	0.5~2.5			

MODULAR PLUG ATTACHING/DETACHING TOOL

PP606-140

CUTTER STOPPER FUNCTION Just one tool can compress, cut, and strip communication cables.



Crimping function

Cablecut function

Stripper function

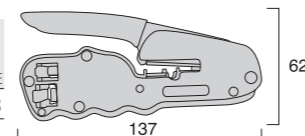

No.	SIZE mm	WEIGHT g/w	CRIMPING TERMINAL CAPACITY SIZE	WIRE SIZE (mm ²)	PACKAGE SIZE H×W×Dmm	Quantity	JAN CODE
PP606-140	140	308	8P RJ45/6P RJ11	Flat cable, CAT5e (Φ5~5.5)	237×120×26	6	084113

*There are some instances where plugs developed specifically by a maker may not be supported.

*The last six digits of JAN (Japanese Article Numbering) Code are displayed with the manufacturer code [4952520] omitted.

By polishing the blade even further, an even sharper cut has been created.

CRIMPING PLIERS

FA101 Insulated terminals
FA102 Non-Insulated terminals
FA103 Faston terminals



Polishing the blade.

- ① CRIMPING for Insulated terminals FA101
- ② CRIMPING for Non-Insulated terminals FA102
- ③ CRIMPING for Faston terminals FA103
- ④ CUTTING for SMALL SCREW-BOLT
- ⑤ CUTTING for WIRE
- ⑥ WIRE STRIPPER

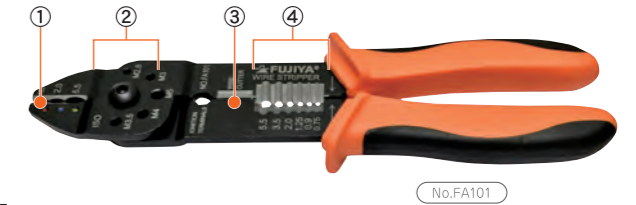

No.FA101

No.	SIZE mm	WEIGHT g/w	PACKAGE SIZE H×W×Dmm	Quantity	JAN CODE
FA101	225	300	290×85×15	12	067079
FA102					067086
FA103					067093

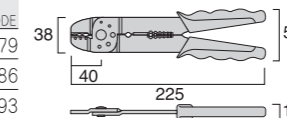

CRIMPING PLIERS

FA104 Insulated & non-insulated terminals
FA105 Insulated & faston terminals
FA106 Faston & non-insulated terminals



Polishing the blade.

- ① CUTTING for WIRE
- ② CRIMPING for Insulated terminals FA104/FA105
- ③ CRIMPING for Non-Insulated terminals FA104/FA106
- ④ CRIMPING for Faston terminals FA105
- ⑤ CRIMPING for Faston terminals FA106
- ⑥ WIRE STRIPPER

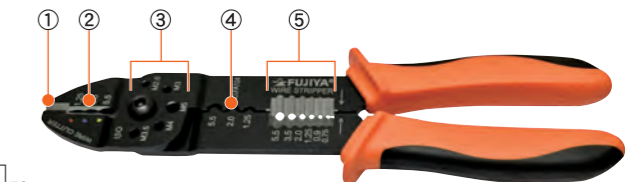

No.FA104

No.	SIZE mm	WEIGHT g/w	PACKAGE SIZE H×W×Dmm	Quantity	JAN CODE
FA104	240	300	290×85×15	12	067109
FA105					067116
FA106					067123

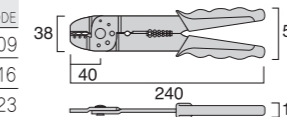

Fully supported when it comes to taking the ECEE. Offers a wide opening that will work in small spaces, too.



TOOL KIT

FDS-01

ELECTRICAL WORK VA STRIPPER
φ1.6×2Core·3Core/φ2.0×2Core·3Core



Greatly reduces working time!

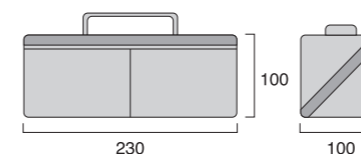

No.	WEIGHT g/w	PACKAGE SIZE H×W×Dmm	JAN CODE
FDS-01	1,490	100×100×200	403204

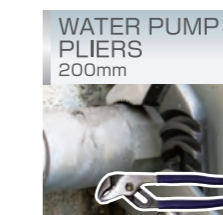

WATER PUMP PLIERS 200mm



SCREW DRIVER (+2) 100mm / (-5.5) 100mm



ELECTRIC WORK KNIFE

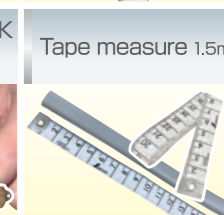

Tape measure 1.5m



Crimping tool Uses a ring sleeve (E) Applicable Range: 1.6×2 Small, Medium

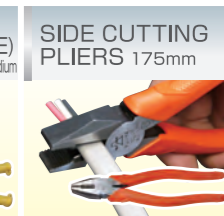

SIDE CUTTING PLIERS 175mm

Allows for easy VA cable stripping.
Produces incredibly effective work for the ECEE.

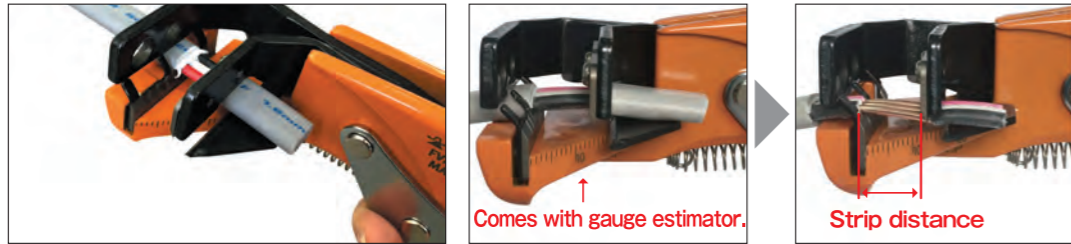

- Grip width is the narrowest in the industry. (114mm)
- Anyone can easily and safely strip cables.
- Comes with convenient gauge estimator.
- Comes with hole for attaching to safety cord.



VA CABLE STRIPPERS FVA-101



Comes with hole for attaching to safety cord.

No.	SIZE mm	WEIGHT g/w	WIRE SIZE				PACKAGE SIZE HxWxDmm	Quantity	JAN CODE
			VVF, EM600V EEF/F						
FVA-101	180	350	φ1.6×2Core	φ1.6×3Core	φ2.0×2Core	φ2.0×3Core	245×115×60	6	083413

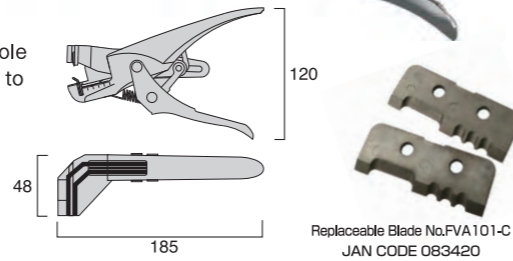

Replaceable Blade No.FVA101-C
JAN CODE 083420

Excellent for any fabrication work that involves VA cables, and includes indoor and outdoor wiring, and electrical installation work.



Able to easily cut through VA and VVF 2-core and 3-core cables that are 1.6φ and 2φ. Easily strips eco material cables beautifully. The nose grip is able to bend cored cables into a "O" shape. This tool is able to strip covered cables beautifully. Main body has a 12mm and a 10cm scale for reference.

ELECTRICAL WORK VA STRIPPER FVA-1620



No.	SIZE mm	WEIGHT g/w	CUTTING PERFORMANCE	WIRE SIZE				PACKAGE SIZE HxWxDmm	Quantity	JAN CODE		
				VA-VVF mm	CORE WIRE SIZE mm	VA/VVF SIZE mm						
FVA-1620	210	200	φ2.0×3Core	φ1.6	φ2.0	φ1.6×2Core	φ1.6×3Core	φ2.0×2Core	φ2.0×3Core	253×73×20	6	083499

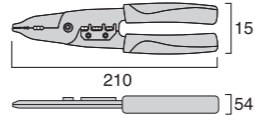

ELECTRICAL WORK KNIFE FK01-180

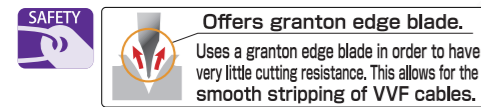

Offers granton edge blade. Uses a granton edge blade in order to have very little cutting resistance. This allows for the smooth stripping of VVF cables.



No.	SIZE mm	WEIGHT g/w	PACKAGE SIZE HxWxDmm	Quantity	JAN CODE
FK01-180	180	100	285×53×25	6	850602

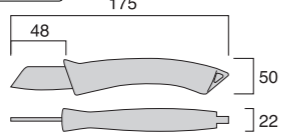

*The last six digits of JAN (Japanese Article Numbering) Code are displayed with the manufacturer code [4952520] omitted.

M-BAR CUTTERS FMC-500

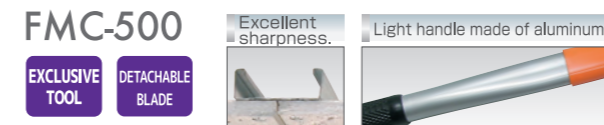

Excellent sharpness. Light handle made of aluminum. Makes a clean cut. By using aluminum in the handle, the overall weight is reduced. This tool is even more beautiful thanks to the anodizing it undergoes.

No.	SIZE mm	WEIGHT g/w	USAGE RANGE	PACKAGE SIZE HxWxDmm	Quantity	JAN CODE
FMC-500	500	1440	Thickness 0.5mm or less. (M-bar)	600×140×35	6	060148
FMC-B	115	-	-	170×73×4	20	060155

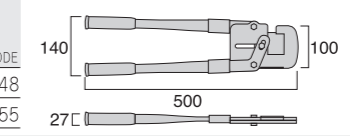

C-CHANNEL CUTTERS FCC-550

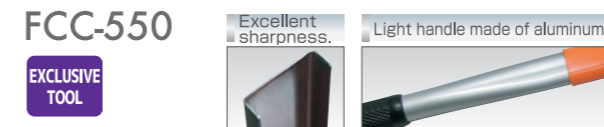

Excellent sharpness. Light handle made of aluminum. Makes a clean cut. By using aluminum in the handle, the overall weight is reduced. This tool is even more beautiful thanks to the anodizing it undergoes.

No.	SIZE mm	WEIGHT g/w	USAGE RANGE	PACKAGE SIZE HxWxDmm	Quantity	JAN CODE
FCC-550	550	1200	Board thickness 1.2mm or less. (C-Channel bar)	600×140×35	6	060162

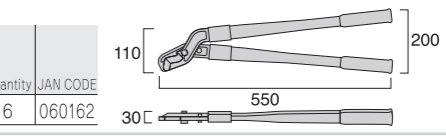

This hammer can be used with threaded bolts, regardless of the depth. The socket has a monkey wrench included in it, as well.



ELECTRICAL PENETRATION HAMMER HT17-255



No.	SIZE mm	WEIGHT g/w	PACKAGE SIZE HxWxDmm	Quantity	JAN CODE
HT17-255	255	420	301×100×25	6	850206

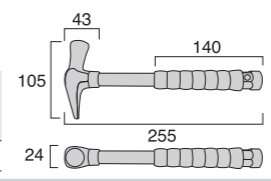

ELECTRICAL PENETRATION HAMMER HT17P-205D



No.	SIZE mm	WEIGHT g/w	PACKAGE SIZE HxWxDmm	Quantity	JAN CODE
HT17P-205D	205	380	257×105×24	6	850237

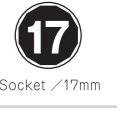
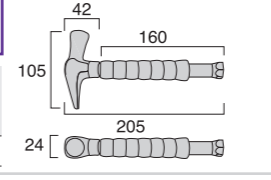

ELECTRICAL PENETRATION HAMMER HT17P-185



No.	SIZE mm	WEIGHT g/w	PACKAGE SIZE HxWxDmm	Quantity	JAN CODE
HT17P-185	185	370	234×105×24	6	850213

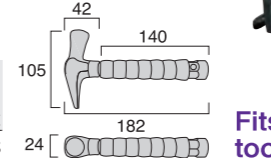

Fits perfectly in a tool bag.



*The last six digits of JAN (Japanese Article Numbering) Code are displayed with the manufacturer code [4952520] omitted.

WIRE CUTTER HWC-5



Finished with dual blades, making it easy to cut both inner and outer wirings for bicycles.



No.	SIZE mm	WEIGHT g/w	CUTTING PERFORMANCE		PACKAGE SIZE H×W×Dmm	Quantity	JAN CODE
			WIRE ROPE mm	STAINLESS STEEL WIRE mm			
HWC-5	180	232	Φ5.0	Φ4.0	241×104×28	5	053133

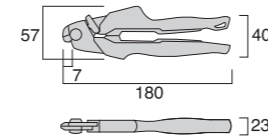

WIRE CUTTER WC1-190



Light thanks to its aluminum handles.

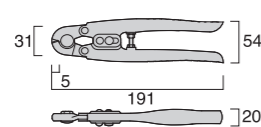

No.	SIZE mm	WEIGHT g/w	CUTTING PERFORMANCE		PACKAGE SIZE H×W×Dmm	Quantity	JAN CODE
			WIRE ROPE mm	STAINLESS STEEL WIRE mm			
WC1-190	190	120	Φ4.0	Φ1.8	260×80×20	6	063088

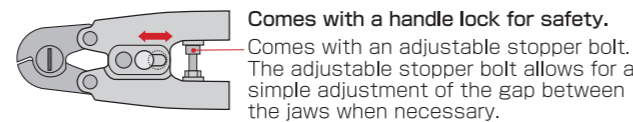

RESIN FLEXIBLE CUTTER

FF28-200

Perfect for plumbing and electrical work!



By reversing the blade from front to back, the tool can be used twice.



No.	SIZE mm	WEIGHT g/w	CUTTING PERFORMANCE		PACKAGE SIZE H×W×Dmm	Quantity	JAN CODE
			Outside diameter mm	Material			
FF28-200	200	170	Φ37	Flexible pipe	278×70×25	6	028087
				OD pipe Φ36			

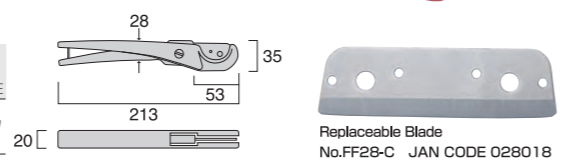

RESIN TUBE CUTTER

FF29-200

Supports pipes from 5"3/4Φ in diameter.



The jaw is extendable which means it supports thicker pipes.



No.	SIZE mm	WEIGHT g/w	CUTTING PERFORMANCE		PACKAGE SIZE H×W×Dmm	Quantity	JAN CODE
			Outside diameter mm	Material			
FF29-200	200	200	Φ34	PE&HIPV ~ Φ25 (nominal size)	280×86×30	6	028094
				Wiring molding No.0~3 (nominal size)			

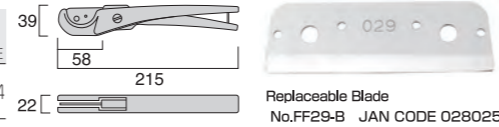

6-PC.PRECISION SCREWDRIVER SET

FPD-6S

No.	CASE SIZE mm	WEIGHT g/w	SCREWDRIVER 6PCS		PACKAGE SIZE H×W×Dmm	Quantity	JAN CODE
			Size	Material			
FPD-6S	135×85×19	167	Φ0.0, Φ0.1	1.4mm, 1.8mm, 2.3mm	191×110×25	10	403129



ELECTRIC TEST DRIVER (-) 100-380V

FKD-01

No.	WEIGHT g/w	CAPACITY		PACKAGE SIZE H×W×Dmm	Quantity	JAN CODE
		Voltage	Current			
FKD-01	20	Low voltage current tester	AC100~380V	160×45×30	12	403129

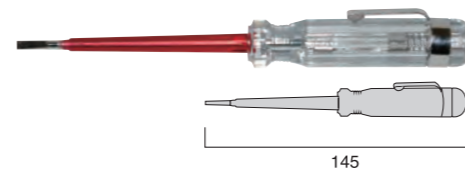

※The last six digits of JAN (Japanese Article Numbering) Code are displayed with the manufacturer code [4952520] omitted.

⚠ Do not use any of these products on anything that has an electrical current. There is a risk of electrical shock. ⚠ Be sure to thoroughly read the [Safety Warning] that is listed with each product's description.

HEAVY DUTY DIAGONAL CLIPPERS



Excellent for cutting through piano wires with its super-light aluminum body!

By using aluminum in the handle, the overall weight is reduced. This tool is even more beautiful thanks to the anodizing it undergoes. Now improved to allow a 12mm shaft diameter carabiner to pass through.



Comes with an adjustable stopper bolt. The adjustable stopper bolt allows for a simple adjustment of the gap between the jaws when necessary.

HEAVY DUTY DIAGONAL CLIPPERS

PC11-200



No.	SIZE mm	WEIGHT g/w	CUTTING PERFORMANCE		PACKAGE SIZE H×W×Dmm	Quantity	JAN CODE
			STEEL WIRE mm	PIANO WIRE mm			
PC11-200	200	160	Φ4.0	Φ2.0	260×80×20	6	065068

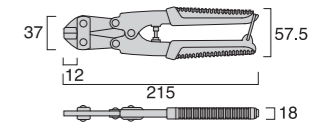

HEAVY DUTY DIAGONAL BENT CLIPPERS

PC12-200



No.	SIZE mm	WEIGHT g/w	CUTTING PERFORMANCE		PACKAGE SIZE H×W×Dmm	Quantity	JAN CODE
			STEEL WIRE mm	PIANO WIRE mm			
PC12-200	200	175	Φ4.0	Φ2.0	260×80×20	6	065075

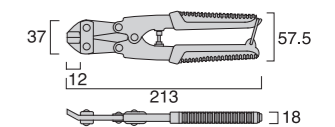

HEAVY DUTY DIAGONAL CLIPPERS

PC13-200



No.	SIZE mm	WEIGHT g/w	CUTTING PERFORMANCE		PACKAGE SIZE H×W×Dmm	Quantity	JAN CODE
			STEEL WIRE mm	COPPER WIRE mm			
PC13-200	200	160	Φ4.0	Φ4.0	260×80×20	6	065082

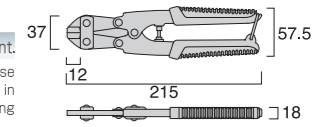
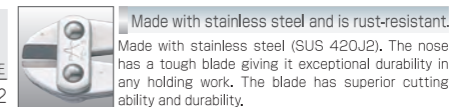

HEAVY DUTY DIAGONAL CLIPPERS

PC5-280



No.	SIZE mm	WEIGHT g/w	CUTTING PERFORMANCE			PACKAGE SIZE H×W×Dmm	Quantity	JAN CODE
			STEEL WIRE mm	COPPER WIRE mm	PIANO WIRE mm			
PC5-280	280	245	Φ5.0	Φ12.0	Φ2.0	340×110×20	6	065051

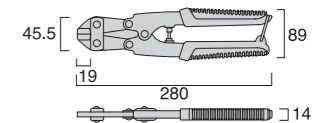

※The last six digits of JAN (Japanese Article Numbering) Code are displayed with the manufacturer code [4952520] omitted.

STORAGE RELATION

WAIST HOLDER BAG.....	64
PLIER HOLDER.....	65
PEN TYPE INPACT DRIVER HOLDER ..	65
SUPPORT BELT.....	66
SUSPENDERS	66
SUSPENDERS SET	66
WAIST HOLDER BAG TYPE-B.....	66
WAIST HOLDER BAG TYPE-C.....	66
ACTIVE POUCH.....	67
LINEMAN'S TOTE BAG	67

SAFETY CODE	67
PLIER HOLDER	68
RATCHET HOLDEER.....	68
CRIMPING TOOL HOLDER.....	68
PLIER HOLDER.....	69
PLIER HOLDER SMALL.....	69
PLIER HOLDER LARGE.....	69
TOOL BAG(HIPPO CASE) GREEN.....	70
TOOL BAG(HIPPO CASE) GRAY.....	70
TOOL BAG(HIPPO CASE) ICE GRAY.....	70

WAIST LINE SERIES<BAG>

Using heavy-duty EVA to the bottom parts.
It resists breaking through the bottom
by point of tools and screws.



Now comes with reinforced pocket material to prevent ripping.

Has undergone a design change and now features an easier to use pocket flap. (WB-32,42)



Includes a D-ring for attaching to a safety cord.



Includes convenient tape measure holder. (WB-12,23)

WAIST HOLDER BAG WB-12
Specialized pocket shape type bag designed for electricians.

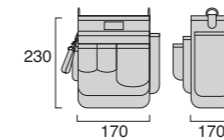

No.	WEIGHT g/w	PACKAGE SIZE HxWxDmm	Quantity	JAN CODE
WB-12	550	230x170x170	10	412800

WAIST HOLDER BAG WB-23
An orthodox 3-level type bag.

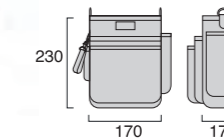

No.	WEIGHT g/w	PACKAGE SIZE HxWxDmm	Quantity	JAN CODE
WB-23	540	230x170x170	10	413012

WAIST HOLDER BAG WB-32
Thin-style bag which won't hinder work with a covered pocket.

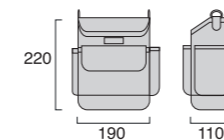

No.	WEIGHT g/w	PACKAGE SIZE HxWxDmm	Quantity	JAN CODE
WB-32	370	220x190x110	10	412817

WAIST HOLDER BAG WB-42
Thin-style slim bag.

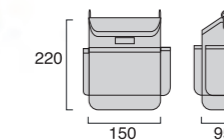

No.	WEIGHT g/w	PACKAGE SIZE HxWxDmm	Quantity	JAN CODE
WB-42	300	220x150x95	20	412824

*The last six digits of JAN (Japanese Article Numbering) Code are displayed with the manufacturer code [4952520] omitted.

⚠ Do not use any of these products on anything that has an electrical current. There is a risk of electrical shock. ⚠ Be sure to thoroughly read the [Safety Warning] that is listed with each product's description.

WAIST LINE SERIES<HOLDER>

Now features an improved holder bottom that will support pliers and nipper tips.



Includes a D-ring for attaching to a safety cord.



PLIER HOLDER PN-11
PLIER or NIPPER ×1



No.	WEIGHT g/w	PACKAGE SIZE H×W×Dmm	Quantity	JAN CODE
PN-11	130	280×100×30	120	412909

PLIER HOLDER PN-22
PLIER or NIPPER ×2
SCREW DRIVER ×2



No.	WEIGHT g/w	PACKAGE SIZE H×W×Dmm	Quantity	JAN CODE
PN-22	190	280×140×50	80	412923

PLIER HOLDER PN-12
PLIER or NIPPER ×2



No.	WEIGHT g/w	PACKAGE SIZE H×W×Dmm	Quantity	JAN CODE
PN-12	150	280×100×50	80	412916

PEN TYPE IMPACT DRIVER HOLDER PD-01R
Items can be stored with tools attached to the tips.



No.	WEIGHT g/w	PACKAGE SIZE H×W×Dmm	Quantity	JAN CODE
PD-01R	130	300×95×60	80	413029



With an excellent fit and feel, these reduce burden and are excellent for working for long periods of time.

SUPPORT BELT SB-01



SUSPENDERS SP-01



SET SPB-01



No.	WEIGHT g/w	PACKAGE SIZE H×W×Dmm	Quantity	JAN CODE
SB-01	390	860×170×40	20	411384
SP-01	335	570×210×40	25	411391
SPB-01(set)	725	860×210×80	10	411407

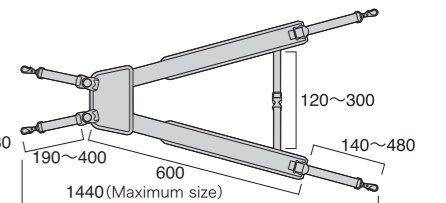
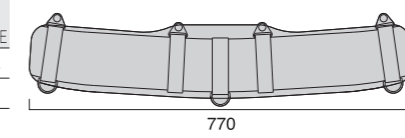

Made of the highest grade tarpaulin material available, the bags resist ripping while reducing rubbing.



The belt loop is 70mm wide.



The bottom uses EVA so the bag will maintain its shape.

Tarpaulin material is water-resistant. They're washable and can be used on rainy days.

WAIST HOLDER BAG TYPE-B WB-BT



No.	WEIGHT g/w	PACKAGE SIZE H×W×Dmm	Quantity	JAN CODE
WB-BT	500	360×210×180	10	411674

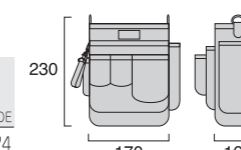

WAIST HOLDER BAG TYPE-C WB-CT



No.	WEIGHT g/w	PACKAGE SIZE H×W×Dmm	Quantity	JAN CODE
WB-CT	530	360×210×180	10	411681

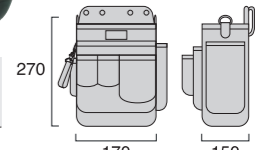

※The last six digits of JAN (Japanese Article Numbering) Code are displayed with the manufacturer code [4952520] omitted.

※The last six digits of JAN (Japanese Article Numbering) Code are displayed with the manufacturer code [4952520] omitted.



Supports many uses, regardless of job!

Design supports all sorts of casual uses, too!



Conveniently able to carry all sorts of small items like a tape measure, a cell phone, and more!

ACTIVE POUCH AP-S/AP-M /AP-E

Comes with a safety cover to prevent falling. Its small size allows for use in narrow spaces.

Easy to use in narrow spaces with the curved bag that fits the shape of one's body.



No.	WEIGHT g/w	PACKAGE SIZE H×W×Dmm	Quantity	JAN CODE
AP-S	180	230×140×110	20	411322
AP-M	220	270×140×110	20	411339
AP-E	270	275×140×65	20	411506



The hand straps are long, allowing one to hang the bag from a shoulder easily.

LINEMAN'S TOTE BAG TT-M

Offers bountiful storage.

Easy to carry.



Comes with a convenient pocket for storing tools. A wide mouth makes it easier for removing and replacing tools.



Easy to carry, and designed with a wider front in order to support removing and replacing tools.



No.	WEIGHT g/w	PACKAGE SIZE H×W×Dmm	Quantity	JAN CODE
TT-M	900	360×440×170	6	411414

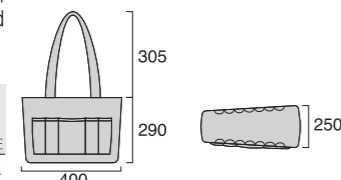

Leather handmade

These individually handmade items are made by artisans using sturdy leather and are proudly made in Japan.



PLIER HOLDER D-ring PLIER or NIPPER ×1 LP-1DSB

90mm wide slim type
Fits a single pair of pliers or nippers.

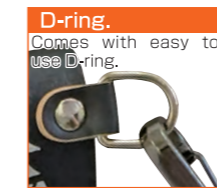

No.	WEIGHT g/w	PACKAGE SIZE H×W×Dmm	Quantity	JAN CODE
LP-1DSB	99	280×140×50	50	412657



PLIER HOLDER D-ring PLIER or NIPPER ×2 LP-3DSB

90mm wide slim type



No.	WEIGHT g/w	PACKAGE SIZE H×W×Dmm	Quantity	JAN CODE
LP-3DSB	120	280×140×60	50	412664



PLIER HOLDER D-ring. PLIER or NIPPER ×1, Screw driver ×2 LP-4DSB

90mm wide slim type

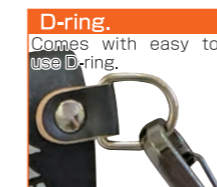

No.	WEIGHT g/w	PACKAGE SIZE H×W×Dmm	Quantity	JAN CODE
LP-4DSB	148	280×140×70	50	412671

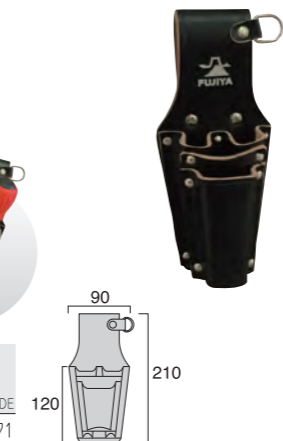

RATCHET HOLDER D-ring. Construction ratchet wrench ×1, Adjustable wrench ×1 LP-9DSB

70mm wide slim type Comes with a stopper to prevent construction ratchet wrenches from leaning.

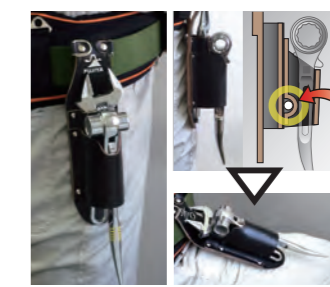

No.	WEIGHT g/w	PACKAGE SIZE H×W×Dmm	Quantity	JAN CODE
LP-9DSB	146	330×140×60	50	412688



PLIER HOLDER LP-8D

Includes a D-ring for attaching to a safety cord.
Supports safety belts up to 70mm wide.
Extra room for storing larger tools, too!

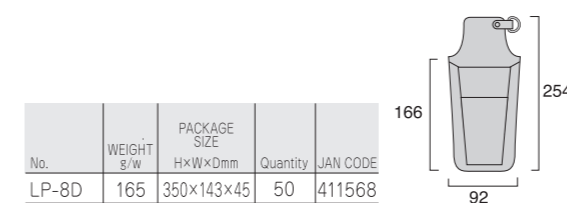

No.	WEIGHT g/w	PACKAGE SIZE H×W×Dmm	Quantity	JAN CODE
LP-8D	165	350×143×45	50	411568

PLIER HOLDER LP-8DS

Includes a D-ring for attaching to a safety cord.
Supports safety belts up to 70mm wide.
The bottom is closed, so tools won't fall through.

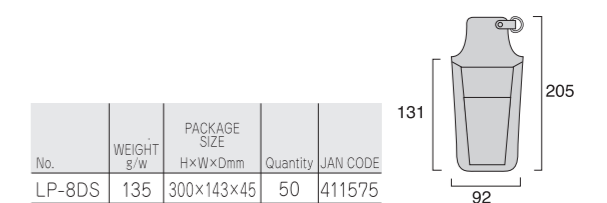

No.	WEIGHT g/w	PACKAGE SIZE H×W×Dmm	Quantity	JAN CODE
LP-8DS	135	300×143×45	50	411575

※The last six digits of JAN (Japanese Article Numbering) Code are displayed with the manufacturer code [4952520] omitted.

※The last six digits of JAN (Japanese Article Numbering) Code are displayed with the manufacturer code [4952520] omitted.

PLIER HOLDER
D-ring PLIER or NIPPER ×1
LP-1D

FUJIYA No.FM02-200
Can store electrical work scissors.

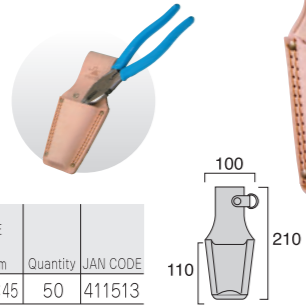

No.	WEIGHT g/w	PACKAGE SIZE H×W×Dmm	Quantity	JAN CODE
LP-1D	90	300×143×45	50	411513

PLIER HOLDER
D-ring PLIER or NIPPER ×2
LP-3D

FUJIYA No.770-200
Can store electrical work diagonal cutting nippers.

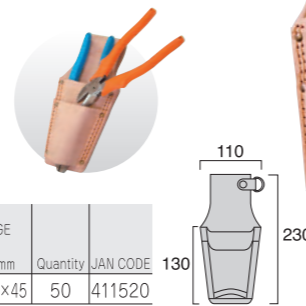

No.	WEIGHT g/w	PACKAGE SIZE H×W×Dmm	Quantity	JAN CODE
LP-3D	150	300×143×45	50	411520

PLIER HOLDER D-ring
PLIER or NIPPER ×1, Screw driver ×2
LP-4D

The small holder can also hold electrical work knives.

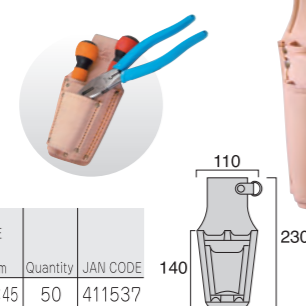

No.	WEIGHT g/w	PACKAGE SIZE H×W×Dmm	Quantity	JAN CODE
LP-4D	170	300×143×45	50	411537

PLIER HOLDER D-ring
PLIER or NIPPER ×3
LP-5D

FUJIYA No.770-200
Can store electrical work diagonal cutting nippers.

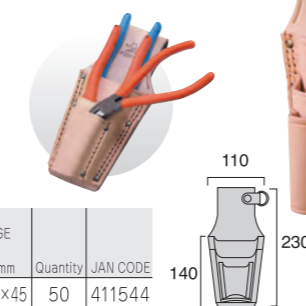

No.	WEIGHT g/w	PACKAGE SIZE H×W×Dmm	Quantity	JAN CODE
LP-5D	160	300×143×45	50	411544

PLIER HOLDER D-ring
PLIER or NIPPER ×2, Screw driver ×2
LP-6D

The screwdriver holder also has a pen slot.

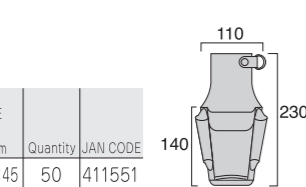
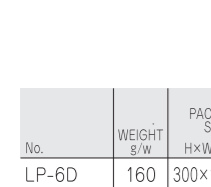

No.	WEIGHT g/w	PACKAGE SIZE H×W×Dmm	Quantity	JAN CODE
LP-6D	160	300×143×45	50	411551

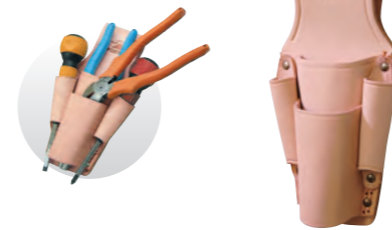

PLIER HOLDER ANGLE CUTTING NIPPERS <S SIZE> ×1
LP-NS

Can store 100mm to 125mm diagonal cutting nippers.
The belt loop is 50mm wide.

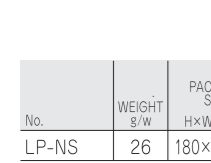

No.	WEIGHT g/w	PACKAGE SIZE H×W×Dmm	Quantity	JAN CODE
LP-NS	26	180×85×40	50	411346



PLIER HOLDER ANGLE CUTTING NIPPERS <L SIZE> ×1
LP-NL

Can store 125mm to 150mm diagonal cutting nippers.
The belt loop is 50mm wide.

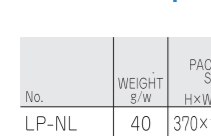

No.	WEIGHT g/w	PACKAGE SIZE H×W×Dmm	Quantity	JAN CODE
LP-NL	40	370×145×45	50	411353



HIPPO CASE
Opens wide for an easy view of contents and removing and replacing items.

Point 1

Opens wide for easy removal and replacement of items.

Point 2

Easily portable. No need to close before transporting.

Point 4

Comes with a convenient inside pocket.

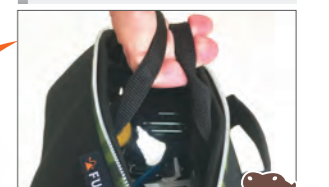

Point 3

Sturdy material

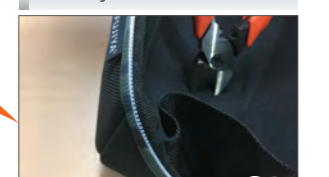

Use it anywhere for anything!

Available in small, medium, and large.

HIPPO CASE (Camouflage green)
FHC-SG /FHC-MG /FHC-LG

Available in small, medium, and large.

No.	SIZE	H×W×Dmm	Quantity	JAN CODE
FHC-SG	S	220×95×95	50	411803
FHC-MG	M	270×110×110	30	411810
FHC-LG	L	305×120×125	50	411827

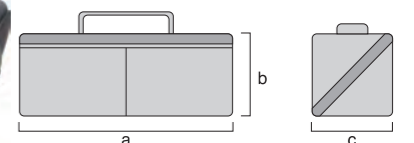

Inside dimension

S SIZE	a:180mm	b:75mm	c:70mm
M SIZE	a:235mm	b:95mm	c:90mm
L SIZE	a:270mm	b:100mm	c:105mm

HIPPO CASE (Camouflage gray)
FHC-SA /FHC-MA /FHC-LA

Available in small, medium, and large

No.	SIZE	H×W×Dmm	Quantity	JAN CODE
FHC-SA	S	220×95×95	50	411834
FHC-MA	M	270×110×110	30	411841
FHC-LA	L	305×120×125	50	411858

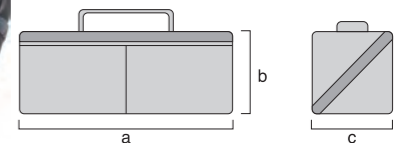

Inside dimension

S SIZE	a:180mm	b:75mm	c:70mm
M SIZE	a:235mm	b:95mm	c:90mm
L SIZE	a:270mm	b:100mm	c:105mm

HIPPO CASE (Ice gray)
FTC2-MIG /FTC2-LIG /FTC2-2LIG

Available in medium, large, and extra-large.

No.	SIZE	H×W×Dmm	Quantity	JAN CODE
FTC2-MIG	M	270×110×110	30	411711
FTC2-LIG	L	305×120×125	24	411742
FTC2-2LIG	2L	410×150×155	24	411773

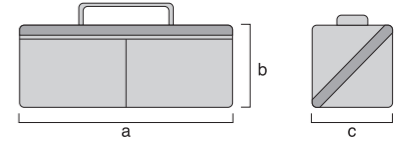

Inside dimension

M SIZE	a:235mm	b:95mm	c:90mm
L SIZE	a:270mm	b:100mm	c:105mm
2L SIZE	a:370mm	b:130mm	c:135mm

※The last six digits of JAN (Japanese Article Numbering) Code are displayed with the manufacturer code [4952520] omitted.

※The last six digits of JAN (Japanese Article Numbering) Code are displayed with the manufacturer code [4952520] omitted.

By connecting tools to a safety belt, accidents, such as dropping one's tools from high places, can be avoided.



STRONG Speciallywoven fibers are very long-lasting and resist stretching out.

EFFICIENCY Unlike coil types, these do not wrap around arms and clothes while one is working.

PATENTED! Work efficiency is increased because specially woven fibers have rubber sewn into them and allow for expansion and contraction.



SAFETY CODE<5kg TYPE>

BLUE FSC-5B PINK FSC-5P PURPLE FSC-5M

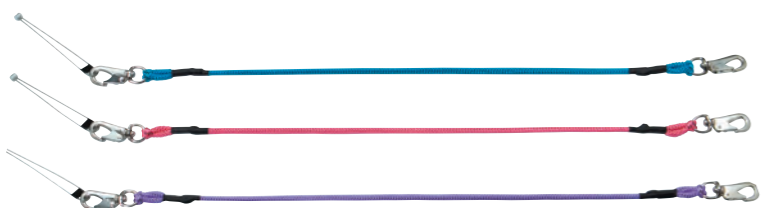

No.	WEIGHT g/w	PACKAGE SIZE HxWxDmm	Quantity	JAN CODE
BLUE FSC-5B	135	320x50x25	10	412022
PINK FSC-5P	135	320x50x25	10	412008
PURPLE FSC-5M	135	320x50x25	10	412015

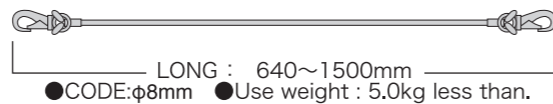

SAFETY CODE<3kg TYPE>

SILVER FSC-3SL



No.	WEIGHT g/w	Quantity	JAN CODE
SILVER FSC-3SL	78	10	412626

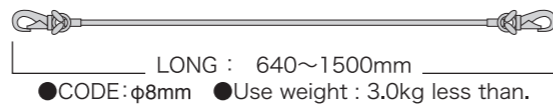

※The last six digits of JAN (Japanese Article Numbering) Code are displayed with the manufacturer code [4952520] omitted.

HEXAGON WRENCH

- BALL-POINT HEX KEY WRECH..... 73
- HEX KEY WRECH..... 74
- BALL-POINT HEX KEY WRECH <Short neck type> 74
- DOUBLE BALL WRENCH 75
- STICK BALL WRENCH..... 75
- SUPPORTING HANDLE..... 75
- TRIPLE HANDLE 76
- RETURN HANDLE..... 76
- HANDLE ADAPTER 76
- PIPE HANDLE..... 76
- PIERCE BALL WRENCH..... 77



SUPER BALL WRENCH
It's speedily fit hexagon socket head cap screw it because the tip processed to ball shape.



DODECAGON WRENCH
Dodecagon wrench can turn cap screw by 30° rotation angle.



CUT BALL HEAD
Even when it is tilted, the tip enters deep into the screw hole, and torque can be applied firmly.



BALL POINT HEAD
Use of upto 32° angle off-axis to screw is allowed.



HEX KEY HEAD
HEX KEY wrench beveling minutely end surface and a C surface it makes wrench easily fit hexagon socket head cap screw.



FINAL TIGHTENING
It is possible to tight fastening bystrong torque as Hex Key wrench.



HOT BENT PRICESSING
Hot bent is hard to get broken and it makes the progress of high precision bent which is nearly right angle a reality.



NICKEL CHROME PLATING
The surface is a nickel chrome plated finish that resists rust.



HARD CHROME PLATING
The surface is nickel chrome plated with excellent wear

HEXAGON WRENCH

BALL-POINT HEX KEY WRENCH



It is possible to tight fastening by strong torque as Hex Key wrench.



BALL-POINT HEX KEY WRENCH <long>

No.	Nose shape	Finish	∅ _F mm	L mm	H mm	Quantity	JAN CODE
LB330-15			14	80	1.5	10	4952520404294
LB330-20			16	90	2.0	10	4952520404300
LB330-25		SB	18	105	2.5	10	4952520404317
LB330-30		HC	20	120	3.0	10	4952520404324
LB330-40		HC	22	142	4.0	10	4952520404331
LB330-50		HC	25	160	5.0	10	4952520404348
LB330-60			28	184	6.0	10	4952520404355
LB330-80			32	203	8.0	10	4952520404362
LB330-100			36	227	10.0	10	4952520404379

BALL-POINT HEX KEY WRENCH SET <long>

No.	W×H×D	Set items	Quantity	JAN CODE
LB330-95	79×227×17	1.5/2.0/2.5/3.0/4.0/5.0/6.0/8.0/10	6	4952520404287
LB330-75	54×184×12	1.5/2.0/2.5/3.0/4.0/5.0/6.0	6	4952520404270

BALL-POINT HEX KEY WRENCH SET <short>

No.	Nose shape	Finish	∅ _F mm	L mm	H mm	Quantity	JAN CODE
LB130-15			14	50	1.5	10	4952520404409
LB130-20			16	55	2.0	10	4952520404416
LB130-25		SB	18	60	2.5	10	4952520404423
LB130-30		HC	20	66	3.0	10	4952520404430
LB130-40		HC	22	73	4.0	10	4952520404447
LB130-50		HC	25	82	5.0	10	4952520404454
LB130-60			28	92	6.0	10	4952520404461
LB130-80			32	104	8.0	10	4952520404478
LB130-100			36	120	10.0	10	4952520404485

BALL-POINT HEX KEY WRENCH SET <short>

No.	W×H×D	Set items	Quantity	JAN CODE
LB130-95	79×121×17	1.5/2.0/2.5/3.0/4.0/5.0/6.0/8.0/10	6	4952520404393
LB130-75	54×101×12	1.5/2.0/2.5/3.0/4.0/5.0/6.0	6	4952520404386

HEX KEY WRENCH



HEX KEY WRENCH <long>

No.	Nose shape	Finish	∅ _F mm	L mm	H mm	Quantity	JAN CODE
LH330-15			14	80	1.5	10	4952520404515
LH330-20			16	90	2.0	10	4952520404522
LH330-25			18	105	2.5	10	4952520404539
LH330-30		HC	20	120	3.0	10	4952520404546
LH330-40		HC	22	142	4.0	10	4952520404553
LH330-50		HC	25	160	5.0	10	4952520404560
LH330-60			28	184	6.0	10	4952520404577
LH330-80			32	203	8.0	10	4952520404584
LH330-100			36	227	10.0	10	4952520404591

HEX KEY WRENCH SET <long>

No.	W×H×D	Set items	Quantity	JAN CODE
LH330-95	79×227×17	1.5/2.0/2.5/3.0/4.0/5.0/6.0/8.0/10	6	4952520404508
LH330-75	54×184×12	1.5/2.0/2.5/3.0/4.0/5.0/6.0	6	4952520404492



HEX KEY WRENCH SET <short>

No.	Nose shape	Finish	∅ _F mm	L mm	H mm	Quantity	JAN CODE
LH130-15			14	50	1.5	10	4952520404409
LH130-20			16	55	2.0	10	4952520404416
LH130-25			18	60	2.5	10	4952520404423
LH130-30		HC	20	66	3.0	10	4952520404430
LH130-40		HC	22	73	4.0	10	4952520404447
LH130-50		HC	25	82	5.0	10	4952520404454
LH130-60			28	92	6.0	10	4952520404461
LH130-80			32	104	8.0	10	4952520404478
LH130-100			36	120	10.0	10	4952520404485

HEX KEY WRENCH SET <short>

No.	W×H×D	Set items	Quantity	JAN CODE
LH130-95	79×121×17	1.5/2.0/2.5/3.0/4.0/5.0/6.0/8.0/10	6	4952520404614
LH130-75	54×101×12	1.5/2.0/2.5/3.0/4.0/5.0/6.0	6	4952520404607

BALL-POINT HEX KEY WRENCH < Short neck type >



BALL-POINT HEX KEY WRENCH <Short neck type / long>

No.	Nose shape	Finish	∅ _F mm	L mm	H mm	Quantity	JAN CODE
LB310-15			4.5	80	1.5	10	4952520409138
LB310-20			5.0	90	2.0	10	4952520409145
LB310-25		SB	5.5	105	2.5	10	4952520409152
LB310-30		HC	6.5	120	3.0	10	4952520409169
LB310-40		HC	8.0	142	4.0	10	4952520409176
LB310-50		NC	9.0	160	5.0	10	4952520409183
LB310-60			10.5	184	6.0	10	4952520409190
LB310-80			13.0	203	8.0	10	4952520409206
LB310-100			16.0	227	10.0	10	4952520409213

BALL-POINT HEX KEY WRENCH SET <Short neck type / long>

No.	W×H×D	Set items	Quantity	JAN CODE
LB310-95	79×227×17	1.5/2.0/2.5/3.0/4.0/5.0/6.0/8.0/10	6	4952520409121
LB310-75	54×184×12	1.5/2.0/2.5/3.0/4.0/5.0/6.0	6	4952520409114

BALL-POINT HEX KEY WRENCH SET <Short neck type / short>

No.	Nose shape	Finish	∅ _F mm	L mm	H mm	Quantity	JAN CODE
LB110-15			4.5	50	1.5	10	4952520409244
LB110-20			5.0	58	2.0	10	4952520409251
LB110-25		SB	5.5	65	2.5	10	4952520409268
LB110-30		HC	6.5	75	3.0	10	4952520409275
LB110-40		HC	8.0	79	4.0	10	4952520409282
LB110-50		NC	9.0	90	5.0	10	4952520409299
LB110-60			10.5	101	6.0	10	4952520409305
LB110-80			13.0	111	8.0	10	4952520409312
LB110-100			16.0	121	10.0	10	4952520409329

BALL-POINT HEX KEY WRENCH SET <Short neck type / short>

No.	W×H×D	Set items	Quantity	JAN CODE
LB110-95	79×121×17	1.5/2.0/2.5/3.0/4.0/5.0/6.0/8.0/10	6	4952520409237
LB110-75	54×101×12	1.5/2.0/2.5/3.0/4.0/5.0/6.0	6	4952520409220

DOUBLE BALL WRENCH



It is a wrench whose both ends are machined into ball points. The ball point on the small L side has a shape with the tip cut <Cut ball head>, it is not easy break.



● Because the point where force is applied is deep, it is not easy break.

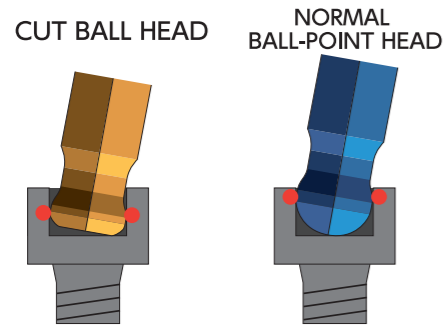

BALL-POINT HEX KEY WRENCH <both ends are ball point type>
 ※LW330-15,20 are not DOUBLE BALL(not CUT BALL HEAD)

No.	Color	Nose shape	Finish	φ	L _{mm}	H _{mm}	Quantity	JAN CODE
LW330C-15	■			14	80	1.5	10	4952520404904
LW330C-20	■			16	90	2.0	10	4952520404911
LW330C-25	■			18	105	2.5	10	4952520404928
LW330C-30	■			20	120	3.0	10	4952520404935
LW330C-40	■			22	142	4.0	10	4952520404942
LW330C-50	■			25	160	5.0	10	4952520404959
LW330C-60	■			28	184	6.0	10	4952520404966
LW330C-80	■			32	203	8.0	10	4952520404973
LW330C-100	■			36	227	10.0	10	4952520404980

BALL-POINT HEX KEY WRENCH SET <both ends are ball point type> ※1.5,2.0 are not DOUBLE BALL(not CUT BALL HEAD)

No.	Nose shape	Finish	W×H×D	Set items	Quantity	JAN CODE
LW330C-9S			79×232×17	1.5 ■ 2.0 ■ 2.5 ■ 3.0 ■ 4.0 ■ 5.0 ■ 6.0 ■ 8.0 ■ 10 ■	6	4952520404898

STICK BALL WRENCH



Hexagonal wrench need 60° rotation angle to turn hexagon socket head cap screw. However, Twelve-sided Polygon Wrench can turn cap screw by 30° rotation angle. And also, thanks for short small L side, you can use it in narrow space.



[10mm~4mm]

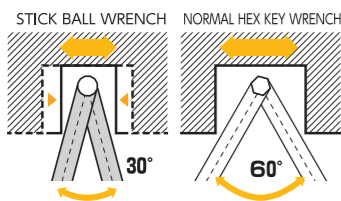

BALL-POINT HEX KEY WRENCH <DODECAGON type>
 ※LB311C-15~30 are not DODECAGON HEAD

No.	Nose shape	Finish	φ	L _{mm}	H _{mm}	Quantity	JAN CODE
LB311C-15			7	80	1.5	10	4952520404737
LB311C-20			8	90	2.0	10	4952520404744
LB311C-25			9	105	2.5	10	4952520404751
LB311C-30			10	120	3.0	10	4952520404768
LB311C-40			12	142	4.0	10	4952520404775
LB311C-50			14	160	5.0	10	4952520404782
LB311C-60			16	184	6.0	10	4952520404799
LB311C-80			18	203	8.0	10	4952520404805
LB311C-100			20	227	10.0	10	4952520404812

Supporting handle

No.	JAN CODE
H-SU	4952520404874

BALL-POINT HEX KEY WRENCH SET <DODECAGON type> ※1.5~3.0 are not DODECAGON HEAD

No.	Nose shape	Finish	W×H×D	Set items	Quantity	JAN CODE
LB311C-9S			79×227×17	1.5 ■ 2.0 ■ 2.5 ■ 3.0 ■ 4.0 ■ 5.0 ■ 6.0 ■ 8.0 ■ 10 ■	6	4952520404720

TRIPLE HANDLE, RETURN HANDLE

Tight fastening and quick turning work in narrow space. By using a combination with ball point, possible to perform tight fastening work with torque applied in a narrow space and quick turning work by interchangeable.

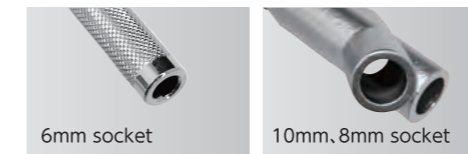

TRIPLE HANDLE (for 6.8,10mm)

No.	Color	W×H×D(mm)	Quantity	JAN CODE
H-T	■	45×273×20	10	4952520404829
H-TB	■	45×273×20	10	4952520404836

Registration of designs T240611W1

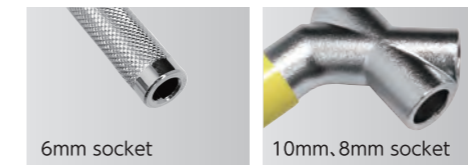
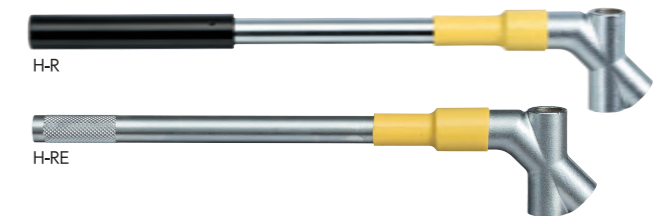

RETURN HANDLE (for 6.8,10mm)

No.	Color	W×H×D(mm)	Quantity	JAN CODE
H-R	■	45×280×17	10	4952520404843
H-RE	■	45×230×20	10	4952520404850

HANDLE ADAPTER

Triple Handle, Return Handle Adpater : You can use handle with ball point, hex key wrench it less than 6mm to put in pierce hole on these handles.

PATENTED 6097136

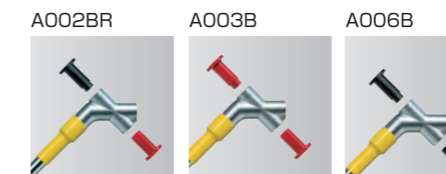

HANDLE ADAPTER

No.	Color	SIZE	Quantity	JAN CODE
A002BR	■	2mm~6mm	10	4952520409084
A003R	■	2mm, 2.5mm, 3mm	10	4952520409091
A006B	■	4mm, 5mm, 6mm	10	4952520409107

PIPE HANDLE

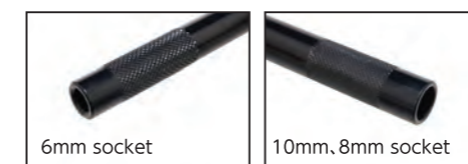

PIPE HANDLE

No.	Color	W×H×D(mm)	Quantity	JAN CODE
H-P	■	16×190×16	10	4952520404867



Excellent for tightening screws in narrow spaces.

By alternating the front and back angles by 15 degrees each, the 60 degree grip normally needed for an Allen wrench can be reduced by half to 30 degrees. (Can be used to alternate between the front and the back.)

With the tip being extremely short, and the body light, this tool really shines when dealing with deep, narrow spaces.



This slant is patented.
No.4308482

Can be used to alternate between the front side and the back side.

15°

Turn-over

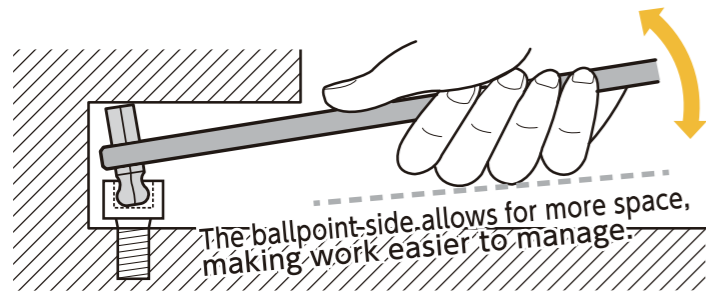
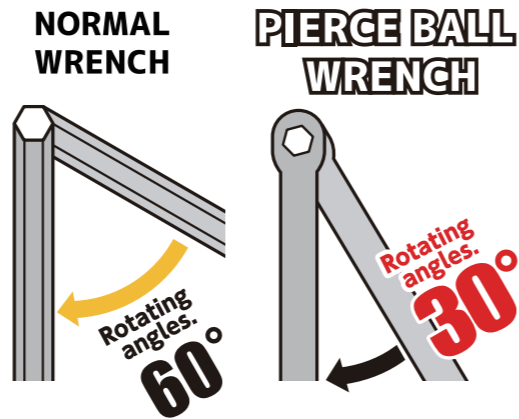

CUTTERS

DRAIN PIPE CUTTER 79
 VINYL PIPE CUTTER 80
 AIRCONDITIONER DUCT CUTTER 81
 FLEXIBLE PIPE CUTTER 82
 VINYL PIPE CUTTER 82
 VA STRIPPER 83
 FINE CERAMIC TWEEZERS 84



PIERCE BALL WRENCH

No.	Tip size	Nose shape	Finish	W×H×D(mm)	Carton Box	JAN CODE
PB310-253	2.5×3.0			5×152×10	10	4952520409008
PB310-304	3.0×4.0			5×152×10	10	4952520409015
PB310-405	4.0×5.0			6×175×12	10	4952520409022
PB310-506	5.0×6.0			8×195×12	10	4952520409039
PB310-608	6.0×8.0			10×216×15	10	4952520409046
PB310-810	8.0×10.0			12×230×15	10	4952520409053

PIERCE BALL WRENCH SET

No.	Set items	Nose shape	Finish	W×H×D(mm)	Carton Box	JAN CODE
PB310-3A	3.0×4.0 5.0×6.0 8.0×10.0			5×152×10 8×195×12 12×230×15	6	4952520409060
PB310-3B	2.5×3.0 4.0×5.0 6.0×8.0			5×152×10 6×175×12 10×216×15	6	4952520409077

AC-25 DRAIN PIPE CUTTER

- Designed for working with package air conditioners.
 - Equipped with a uniquely perfected blade for cutting through air conditioner drain pipes.
 - Leaves a beautifully cut cross section.
 - Reduces frictional resistance on a cut object thanks to unique coating.
 - Created to make best possible cut with an ultra-thin & acutely-angled finish.
 - The blade features a hollow grind blade which allows for an easier cut.
 - Cuts can often result in splintering due to the sharpness of the blade, so exercise caution when in use.
- ※Cannot cut through cable wiring and metal piping, such as steel pipes, bronze pipes, aluminum pipes, etc.



Cutting performance	Maximum outer diameter...φ42
	Air conditioning drain pipe...~φ38
	PVC pipe...~VP30
	PE pipes...~φ40
Weight(g)	330
Size(mm)	LONG : 225 WIDE : 92 DEPTH : 25
JAN CODE	4953998006249



Replaceable Blade AC25-A
JANCODE 4953998006256

Check Victor's video channel for instructions on how to replace the blade.



AC-40 DRAIN PIPE CUTTER

- Designed for working with package air conditioners.
 - Equipped with a uniquely perfected blade for cutting through air conditioner drain pipes.
 - Leaves a beautifully cut cross section.
 - Reduces frictional resistance on a cut object thanks to unique coating.
 - Created to make best possible cut with an ultra-thin & acutely-angled finish.
 - The blade features a hollow grind blade which allows for an easier cut.
 - Cuts can often result in splintering due to the sharpness of the blade, so exercise caution when in use.
- ※Cannot cut through cable wiring and metal piping, such as steel pipes, bronze pipes, aluminum pipes, etc.



Cutting performance	Maximum outer diameter...φ60
	Air conditioning drain pipe...~φ60
	PVC pipe...~VP50
	HIVP pipe...~HIVP50
	PEX pipe...~φ60
PE pipes...~φ50	
Weight(g)	580
Size(mm)	LONG : 280 WIDE : 139 DEPTH : 29
JAN CODE	4953998006263



Replaceable Blade AC40-A
JANCODE 4953998006270

Check Victor's video channel for instructions on how to replace the blade.



VP-36E VINYL PIPE CUTTER

- The high precision grinding of the blade makes it easy to cut objects with one hand.
- Can cut up to outer diameter φ42 such as PVC pipe.
- The number of cuts at the time of cutting can be small and the cut surface can be finished very beautifully.
- With attachment, able to cut diagonally of protector.
- Lightweight and compact design, excellent durability.

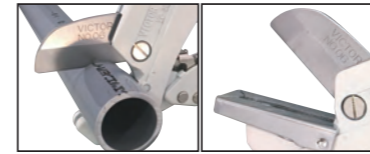

Usage example

Comes with attachment

Cutting performance	Maximum outer diameter...φ42
	PVC pipes...~VP30, VW30, VE36
	PE pipes...~φ42
	Wire protector...No.1~No.5(special)
Cable cover...No.0~No.4	
Weight(g)	330
Size(mm)	LONG : 225 WIDE : 92 DEPTH : 25
JAN CODE	4953998006218



Replaceable Blade 036
JANCODE 4953998006225

Check Victor's video channel for instructions on how to replace the blade.



VP-50E VINYL PIPE CUTTER

- The high precision grinding of the blade makes it easy to cut objects with one hand.
- Cut objects with one hand.
- The number of cuts at the time of cutting can be small and the cut surface can be finished very beautifully.
- Lightweight and compact design, excellent durability.



Usage example

Cutting performance	Maximum outer diameter...φ60
	PVC pipes...~VP30
	HIVP pipes...~HIVP50
	PE pipes...~φ60
Weight(g)	580
Size(mm)	LONG : 280 WIDE : 139 DEPTH : 29
JAN CODE	4953998006188



Replaceable Blade VP26
JANCODE 4953998006195

Check Victor's video channel for instructions on how to replace the blade.



VP-30 VINYL PIPE CUTTER

Cutting performance	Maximum outer diameter...φ38
	PVC pipes...~VP30, VW30, VE28
	PE pipes...~φ38
Weight(g)	480
Size(mm)	LONG : 220
JAN CODE	4953998006027



Replaceable Blade 003
JANCODE 4953998006065

VP-42 VINYL PIPE CUTTER

Cutting performance	Maximum outer diameter...φ42
	PVC pipes...~VP30, VW30, VE36
	PE pipes...~φ42
Weight(g)	500
Size(mm)	LONG : 235
JAN CODE	4953998006041



Replaceable Blade 042
JANCODE 4953998006089

VD-2100 AIRCONDITIONER DUCT CUTTER



Corresponds to 90% of domestic air conditioner ducts!!
Top cutting quality and beautiful cut surface!

- Proprietary duct receiving shape corresponds to 90% of domestic air conditioning ducts.
- Possible to cut from indoor duct (MD-751) to wide duct (SD-100).
- The high precision grinding of the blade makes the sharpness and cutting surface are very beautiful.

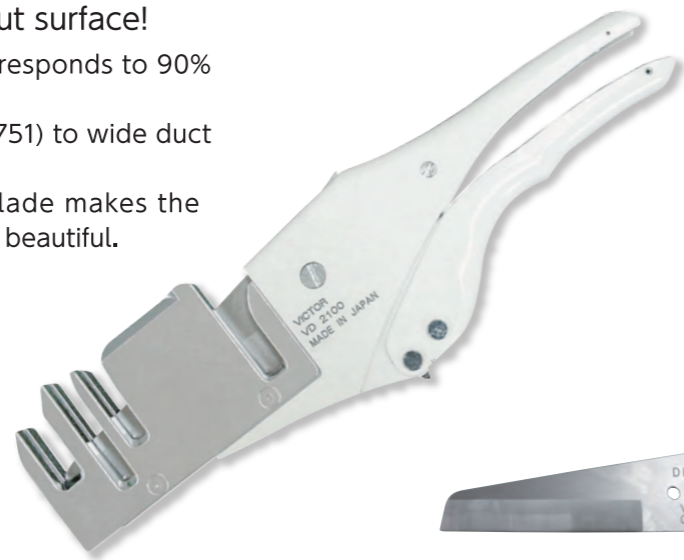

Replaceable Blade VD021
JANCODE 4953998006140

Check Victor's video channel for instructions on how to replace the blade.



Cutting Component Compatibility Chart	INABA...SD-66 SD-77 SD-100 MD-751 LD-70 LD-90
	Panasonic...DAS-060 DAS-080 DAS-010
Weight(g)	570
	INOAC...DD-60 DD-70 DD-100
Size (mm)	LONG : 310 WIDE : 90 DEPTH : 18
	JAN CODE 4953998006133

Correspondence table

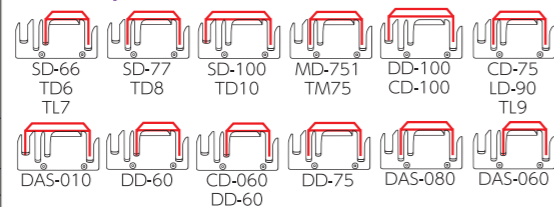

※MD751Please cut sheet by sheet.

VD-2200 AIRCONDITIONER DUCT CUTTER



Corresponds to 90% of domestic air conditioner ducts!!
Top cutting quality and beautiful cut surface!

- Proprietary duct receiving shape corresponds to 90% of domestic air conditioning ducts.
- Possible to cut from indoor duct (MD-751 · 851) to wide duct (SD-100).
- The high precision grinding of the blade makes the sharpness and cutting surface are very beautiful.

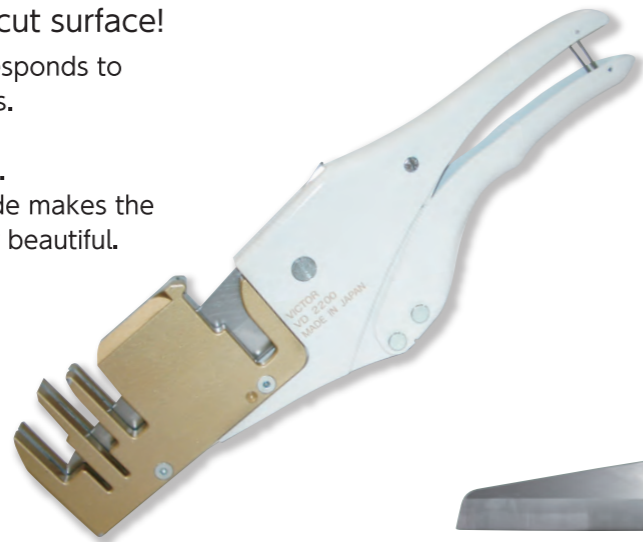

Replaceable Blade VD021
JANCODE 4953998006140

Check Victor's video channel for instructions on how to replace the blade.



Cutting Component Compatibility Chart	INABA...SD-66 SD-77 SD-100 LD-70 LD-90 MD-751 MD-851
	Panasonic...DAS-060 DAS-080 DAS-010
Weight(g)	570
	INOAC...DD-60 DD-75 DD-100 CD-100
Size (mm)	LONG : 310 WIDE : 90 DEPTH : 18
	JAN CODE 4953998006157

Correspondence table

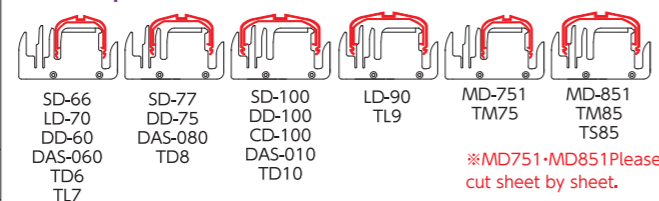

※MD751-MD851Please cut sheet by sheet.

VC-28 FLEXIBLE PIPE CUTTER



- Suitable for cutting general resin flexible pipes, crosslinked polyethylene pipes for hot water supply and water supply work, and polybutene pipes.
- It can be cut to a pipe with an outer diameter of $\phi 37$.
- Blades can be used twice by replacing back and forth.



Check Victor's video channel for instructions on how to replace the blade.



Replaceable Blade 028
JANCODE 4953998007024



Cutting performance	Maximum outer diameter... $\phi 37$ ~ $\phi 36$
	Resin flexible pipes Sheath pipes (CD pipes) PTFE tube PTFE tube
Weight(g)	170
	~ $\phi 27$ (20A) Polybutene pipes Cross-linked PE pipes Nylon robe
Size (mm)	LONG : 200 WIDE : 39 DEPTH : 24
	JAN CODE 4953998007055

VM-29 VINYL PIPE CUTTER



- Suitable for cutting crosslinked polyethylene pipes for hot water supply and water supply work, and polybutene pipes.
- The receiving part according to the pipe diameter prevents the deformation of the pipe and reduces the cutting load by 40% compared to the conventional product. It can cut from rubber hose to HIVE pipe in one cut.
- By sliding the receiving part, can be dealt with a pipe with an outer diameter of 34. Wiring mall cutting is also possible.

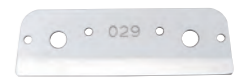

Replaceable Blade 029
JANCODE 4953998007079

Check Victor's video channel for instructions on how to replace the blade.



Cutting performance	Maximum outer diameter... $\phi 34$ ~25 (Nominal size)
	PE pipes PE pipes Polybutene pipes HIVE pipes HIVE pipes
Weight(g)	200
	~ $\phi 34$ CPVC pipes CD pipes Sheath pipes
Size (mm)	LONG : 200 WIDE : 49 DEPTH : 24
	JAN CODE 4953998007062

Does not warp pipes.

Works with wiring molding.



6003VA VA STRIPPER



- VVF, or VA (low voltage distribution) cable strippers. Also, four types of "Eco Material" low-voltage power cable (non PVC, 600V EEF/F): DIA 1.6/2 cores, 3 cores, DIA 2.0/2 cores and 3 cores, can also be striped with ease.
- The width between two grips is the industry's smallest (114 mm) and easy to hold with one hand.
- Possible to strip with about 20% lighter grasping power than conventional products by unique guide mechanism.
- With a handy standard gauge.
- Blade replacement is easily possible.



Check Victor's video channel for instructions on how to replace the blade.



4 sizes available

Cable size	Cutting performance		Weight(g)	Size (mm)	JAN CODE
	Wire size	Wire size			
2core	φ1.6mm φ2.0mm	·VVF(600V Vinyl Insulated Vinyl sheathed Flat-type cable) ·EM EEF/F(Eco-Material polyEthylene insulated Flat-type cable/Flame-retardant)	350	185	4953998 007710
3core	φ1.6mm φ2.0mm				

How to use

Points for making an accurate, beautiful stripping.

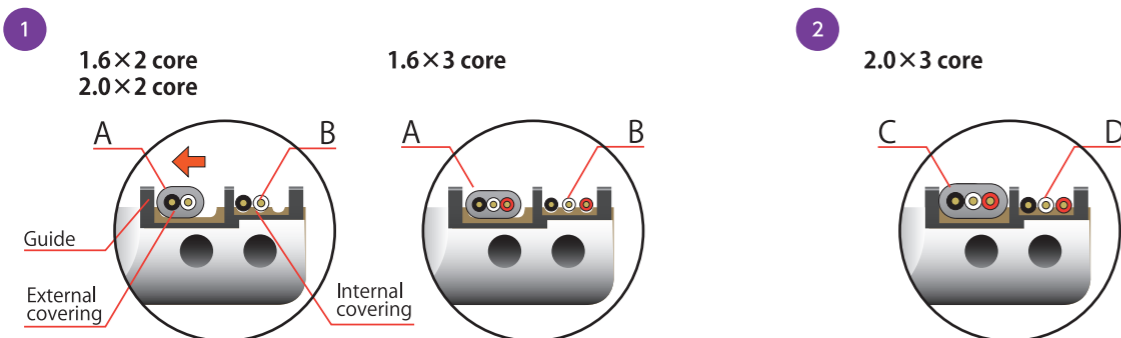

- 1 For the external covering of 1.6 x 2-core cables, 1.6 x 3-core cables, and 2.0 x 2-core cables, please follow A in image 1. For the internal covering, try to inlay following the groove of the blade as outlined in B.
For the external covering of a 2.0 x 3-core cable, follow the blade's arrangement as indicated in C of image 2. For the internal covering, try to inlay following the groove of the blade as outlined in D.

When dealing with wire rods, insert the blade of your tool vertically.

- 2 If you are stripping the internal and external coverings, press the blade into the internal cover just until it presses through the material, the same goes for the external covering, but use the upper edge of the blade, and gently grasp the lever as you strip. See image 3 for more information.

If you are stripping the internal covering, make sure the E doesn't go into the external covering.

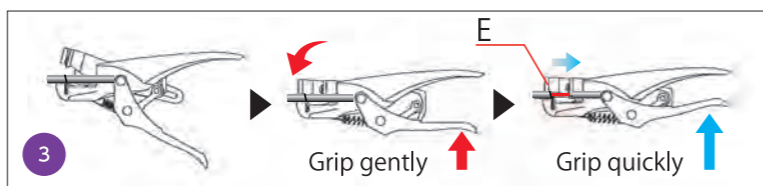

Usage example

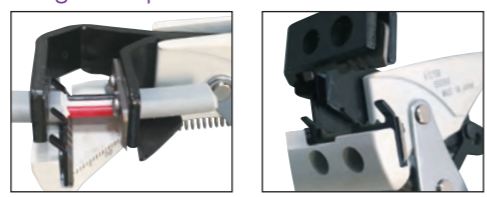

The unique all ceramic made tweezers.

VICTOR's ceramic tweezers are made of zirconia, which is the most strong of all ceramics. Also they have elasticity, so that it is extremely easy to grasp and suitable for detailed work. In addition, since the entire body is made of ceramic, all ceramic tweezers are widely used in precision equipment factories that dislike magnetism and electro static. Widely used also in the medical and research fields that require chemical resistance.

Characteristics of ceramic tweezers

- Heat resistance: (up to 700 degrees C, thermal shock resistance 350 degrees C)
- Rich in chemical resistance (Except hydrofluoric acid)
- No metal contamination or elution of organic matter.
- Nonmagnetic and insulating.
- Outstanding wear resistance (10 times more than metal, 100 times more than plastic)
- It is hard to attach solder or silver solder.



8501 FINE CERAMIC TWEEZERS

Standard type has rounded tips of 0.5R, suitable for any general work. There are streaks inside of the tips.

No.	Size (mm)	Nose shape	Weight(g)	Quantity	JAN CODE
8501	125	with INDENTATION	20	6	4953998007802



8501-F FINE CERAMIC TWEEZERS

Tips are the same as the 8501 type, but the inside of the tips are flat. Suitable when you want to avoid scratching the work.

No.	Size (mm)	Nose shape	Weight(g)	Quantity	JAN CODE
8501-F	125	without INDENTATION	20	6	4953998007819



8501-GG FINE CERAMIC TWEEZERS

Shape of the tips are sharper and pointed, suitable for detailed work. The inside of the tips are flat.

No.	Size (mm)	Nose shape	Weight(g)	Quantity	JAN CODE
8501-GG	125	SHARP	15	6	4953998007826



8507 FINE CERAMIC TWEEZERS

Tips are bent like an eagle's beak and can be used differently from the standard tip type.

No.	Size (mm)	Nose shape	Weight(g)	Quantity	JAN CODE
8507	120	BENT TYPE	18	6	4953998007833



< FUJIYA GROUP >

FUJIYA CO.,LTD.

2-6-32, Matsubara, Higashi-Osaka City, Osaka Prefecture 578-0922, Japan

HP:<http://www.fujiya-kk.com/en/>

e-mail global@fujiya-kk.com

TOKYO Branch

106 Ryogoku, 2-13-10 Ishihara Sumida-ku, Tokyo Prefecture 130-0011, Japan

Ho Chi Minh Branch

MA Floor, Platinum Building, 145 Dien Bien Phu Street, Da Kao Ward, 1 Dist, Ho Chi Minh City

Ha Noi Branch

No.702, 7F, 223 Quan Hoa Street, Quan Hoa ward, Cau Giay District,

Hanoi Capital, Viet Nam

FUJIYA MANUFACTURING VIETNAM CO.,LTD.

Lot B-3B8-CN, My Phuoc industrial park 3, Thoi Hoa Ward, Ben cat District,

Binh Duong Province

FUJIYA INTERNATIONAL CO.,LTD.

2-6-32, Matsubara, Higashi-Osaka City, Osaka Prefecture 578-0922, Japan

VICTOR CO.,LTD.

2-6-32, Matsubara, Higashi-Osaka City, Osaka Prefecture 578-0922, Japan

HP:<http://www.victor-kk.com>

WISE CO.,LTD.

6-17 Bunsuikoyo Tsubame City, Niigata Prefecture 959-0109, Japan

HP:<http://niigata-honmono.jp/wise/>



Head Office
2-6-32 Matsubara Higashiosaka Osaka Japan 578-0922
Tel +81-72-963-0825 Fax +81-72-963-0835
Mail : global@fujija-kk.com

HP : <http://www.fujija-kk.com/en/>

