



TAIWAN C-MART PRACTICAL TOOLS CO., LTD. / SHANGHAI C-MART TOOLS CO., LTD.

DALU: No.112 Xinchuang Road, Songjiang District, Shanghai

TAIWAN: Water Township, Chiayi County the coarse Village 136-1

Tel.: +86-21-57680361 57680155 Fax.: +86-21-57680361-126

E-mail:cm@smarttools.com shcsmarttools@hotmail.com

<http://www.smarttools.com>



## PRODUCT CATALOG 01







**CONTENTS**

**CONTENTS**

+ Company Profile	P. 001
+ Corporate Brand	P. 002
+ Lifetime Warranty	P. 003
+ Certificates	P.004
+ Global Cooperation	P.005
+ Grease Gun flyer	P.006
+ Product reviews	
Power tools series ( W series )	P.01-10
Power tools accessories	P.11-18
Wrenches and sockets ( F / T series )	P.19-33
Car maintenance tools ( S series )	P.34-35
Tool kits ( K series )	P.36-42
Cutting tools ( A series1 )	P.43-51
Pliers and holding tools ( B series )	P.52-61
Fastening tools ( C series )	P.62-73
Measuring tools ( D series )	P.74-77
Finishing tools ( E series )	P.78-79
Striking & struck tools ( G series )	P.80-81
Miscellaneous items ( H/L/W series)	P.82-90
Gardening & farm tools ( A series2 )	P.91-97
BUDDY tools	P.98



# 001

## + Company Profile

C-MART HAS BEEN ONE OF THE TOP 10 HAND TOOL BRANDS IN TAIWAN AND MAINLAND CHINA FOR MORE THAN A DECADE. FOR THE PAST 3 YEARS C-MART IS GAINING POPULARITY AND RESPECT ALSO IN SOUTH-EASTERN ASIAN COUNTRIES, THE MID-EAST, EAST EUROPE, AFRICA AND SOUTH AMERICA FOR ITS DIVERSIFIED CATEGORIES OF PRODUCTS AND STEADY AND PROMPT SUPPLY AND MOST IMPORTANTLY ITS HIGH QUALITY AND REASONABLE PRICES.

A LIMITED LIFE-TIME WARRANTY IS OFFERED UPON PURCHASING ANY C-MART PRODUCT SO THAT OUR USERS' SATISFACTION IS GUARANTEED TO THE UTMOST EXTENT. WHATEVER COMMENTS, OPINIONS AND EVEN COMPLAINTS ABOUT C-MART PRODUCTS ARE HIGHLY VALUED AND APPRECIATED AND CONSTANT EFFORTS WILL BE MADE TO MAKE IMPROVEMENT ON THEM WHENEVER REQUIRED.

TAIWAN C-MART PRACTICAL TOOLS CO., LTD. / SHANGHAI C-MART TOOLS CO., LTD.



## + Brands



# 002

003

# + Lifetime Warranty

If ANY C-MART product fails due to defects in materials and workmanship, simply return it to your dealer with proof of purchase (sales receipt) and it will be repaired or replaced at the company's option.

This guarantee does not cover wear and tear or misuse of this product.



# + Certificates

ISO9001:2008 CERTIFIED, CHECKED AND VERIFIED EVERY YEAR

One of the top ten tool brands in China

Well-known tool brand in Taiwan, South-Asia, the Mid-east and many developing countries

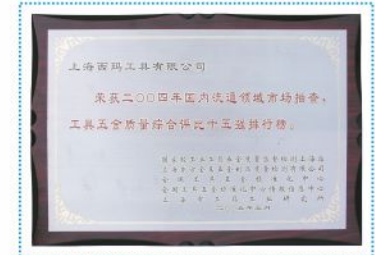

004





# New products

## Fiberglass tape measure

D0008B

Double colour plastic case  
High quality fibre-glass tape  
Both metric, metric & S.A.E. combined graduations available  
**Tape retraction speed 3 times faster**

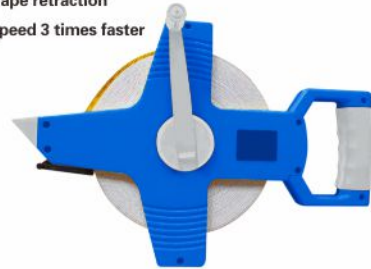

ITEM NO.	SIZE	BOX(CTN/PCS)
D0008B-30	30m	1/-
D0008B-50	50m	1/-
D0008B-100	100m	1/-

## Adjustable wrench

F0201



High carbon steel drop forged, polished and chrome plated

ITEM NO.	SIZE	BOX(CTN/PCS)
F0201-06	150mm/6"	6/72
F0201-08	200mm/8"	6/60
F0201-10	250mm/10"	6/48
F0201-12	300mm/12"	6/24

## High pressure foot pump

L0201



ITEM NO.	SPECS.	BOX(CTN/PCS)
L0201	TWIN PISTONS	1/10

## High pressure foot pump

L0101



ITEM NO.	SPECS.	BOX(CTN/PCS)
L0101	SINGLE PISTON	1/15

## Auto-darkening welding goggles

H0202

Always wear safety goggles at work



ITEM NO.	BOX(CTN/PCS)
H0202	1/-

## Welding machine

W0017B



ITEM NO.	SPECS.	BOX(CTN/PCS)
W0017B-160	MMA-160A	1/-
W0017B-200	MMA-200A	1/-
W0017B-250	MMA-250A	1/-

## Hose nozzle

M0015 M0016 M0017  
M0018 M0019

### Adjustable pistol nozzle

- A heavy duty all metal constructed adjustable pistol nozzle with two types of adaptors
  - Body made of zinc alloy and nozzle and adaptors made of brass for rust resistance and durability
  - On/off trigger with lock
  - Ergonomically shaped trigger for easy and convenient use
  - One 1/2" fast hose connector and one snap-in adaptor
- Push the right hose over the fast connector and tighten it with a clamp to avoid leaking
- Or you can use the snap-in adaptor with a hose connector



ITEM NO.	SPECS.	BOX(CTN/PCS)
M0015	FOR 1/2" HOSE	-

### 3-pattern hose nozzle

- One piece brass hose nozzle with snap-in adaptor and an extra brass hose connector
- All brass construction for rust resistance and durability
- Snap into the hose connector and ready to use



ITEM NO.	SPECS.	BOX(CTN/PCS)
M0016	FOR 1/2" HOSE	-

### 3-pattern hose nozzle

- One piece brass hose nozzle with snap-in adaptor and with additional tap adaptor
- All brass construction for rust resistance and durability
- Connecting tap and 1/2" hose to be better clamped tight to avoid leaking
- Snap into a hose connector



ITEM NO.	SPECS.	BOX(CTN/PCS)
M0017	FOR 1/2" HOSE	-

### 3-pattern hose nozzle

- One piece brass hose nozzle with 1/2" fast hose adaptor and with one additional tap adaptor
- All brass construction for rust resistance and durability
- Connecting tap and 1/2" hose to be better clamped tight to avoid leaking
- Push 1/2" adaptor into water hose fully and tighten with clamp for leak free



ITEM NO.	SPECS.	BOX(CTN/PCS)
M0018	FOR 1/2" HOSE	-

### 3-pattern hose nozzle

- 3-pc hose nozzle set with one 3 section adaptor and one snap-in adaptor
- All brass construction for rust resistance and durability
- Two adaptors can be used with most basin taps or taps with inner thread



ITEM NO.	SPECS.	BOX(CTN/PCS)
M0019	FOR 1/2" HOSE	-

## Cordless hot melt glue gun

C0194

- Patented mechanism shortens the warming-up time from the usual 5 minutes to just 12 seconds.
- Fully charged battery does not run out until 50 glue sticks of regular size are melted.



READY IN 12 SECONDS

ITEM NO.	GLUE STICK SIZE	BOX(CTN/PCS)
C0194	Dia. 7mm	1/-

## Tap adaptor & hose connector

M0021 M0022 M0020



ITEM NO.	SPECS.	BOX(CTN/PCS)
M0021	FOR 1/2" TAP	-



ITEM NO.	SPECS.	BOX(CTN/PCS)
M0022	FOR 1/2" HOSE	-



ITEM NO.	SPECS.	BOX(CTN/PCS)
M0020	FOR 1/2" HOSE AND TAP	-





# POWER TOOLS SERIES

## W series

### Hammer drill

SDS-plus  
2 function-hammer and drill  
Variable speed switch

Double insulated handle for safety  
Forward/reverse rotation function

**W0011-20**  
**W0011-24**  
**W0011-26**



**500W**

ITEM NO.	MAX.HOLE OPENING	BOX(CTN/PCS)
W0011-20	Ø20mm	1/5

Hole diameter: Ø20mm  
No Load Speed: 0-850r/min  
Input Power: 220V-240V~  
Rated Frequency: 50Hz/60Hz



**620W**

ITEM NO.	MAX.HOLE OPENING	BOX(CTN/PCS)
W0011-24	Ø24mm	1/5

Hole diameter: Ø24mm  
No Load Speed: 0-870r/min  
Input Power: 220V-240V~  
Rated Frequency: 50Hz/60Hz



**800W**

ITEM NO.	MAX.HOLE OPENING	BOX(CTN/PCS)
W0011-26	Ø26mm	1/4

Hole diameter: Ø26mm  
No Load Speed: 0-900r/min  
Input Power: 220V-240V~  
Rated Frequency: 50Hz/60Hz



### Electric drill

Input Power: 220V-240V~  
Rated Frequency: 50Hz/60Hz

**W0007**   **W0007A**   **W0007C**



Hole diameter: MaxØ10mm  
No Load Speed: 0-3700r/min

**350W**

ITEM NO.	CHUCK SIZE	BOX(CTN/PCS)
W0007	MaxØ10mm	1/10



Hole diameter: MaxØ10mm  
No Load Speed: 0-3700r/min

**350W**

ITEM NO.	CHUCK SIZE	BOX(CTN/PCS)
W0007A	MaxØ10mm	1/10



Hole diameter: MaxØ13mm  
No Load Speed: 0-1240r/min

**550W**

ITEM NO.	CHUCK SIZE	BOX(CTN/PCS)
W0007C	MaxØ13mm	1/10

### Impact drill

Input Power: 220V-240V~  
Rated Frequency: 50Hz/60Hz

**W0008**



Hole diameter: MaxØ13mm  
No Load Speed: 0-3000r/min

**710W**

ITEM NO.	CHUCK SIZE	BOX(CTN/PCS)
W0008	MaxØ13mm	1/10

### Heavy-duty combihammer

Input Power: 220V-240V~  
Rated Frequency: 50Hz/60Hz

**W0018-1200**  
**W0018-1500**



No Load Speed: 850r/min  
Impact Frequency: 3200r/min

**1200W**

ITEM NO.	RATED POWER	BOX(CTN/PCS)
W0018-1200	1200W	1/2



No Load Speed: 850r/min  
Impact Frequency: 3200r/min

**1500W**

ITEM NO.	RATED POWER	BOX(CTN/PCS)
W0018-1500	1500W	1/2

### Impact drill

Input Power: 220V-240V~  
Rated Frequency: 50Hz/60Hz

**W0008B**



Hole diameter: MaxØ13mm  
No Load Speed: 0-3200r/min

**900W**

ITEM NO.	CHUCK SIZE	BOX(CTN/PCS)
W0008B	MaxØ13mm	1/10

### Demolition hammer

Input Power: 220V-240V~  
Rated Frequency: 50Hz/60Hz  
No Load Speed: 1800r/min

**W0031-65**

**1350W**



ITEM NO.	POWER	BOX(CTN/PCS)
W0031-65	1350W	-/1



### Angle grinder

Input Power: 220V~240V~  
Rated Frequency: 50Hz/60Hz

**W0009** **W0009-700** **W0009-710**  
**W0009-1100** **W0025**



Max Disc Diameter: 100-110mm  
No Load Speed: 10500r/min

ITEM NO.	SPECS.	BOX(CTN/PCS)
W0009	M10 100mm	1/10



Max Disc Diameter: 100-110mm  
No Load Speed: 11000r/min

ITEM NO.	SPECS.	BOX(CTN/PCS)
W0009-700	M10 100mm	1/10



Max Disc Diameter: 100-110mm / 110-125mm  
No Load Speed: 11000r/min

ITEM NO.	SPECS.	BOX(CTN/PCS)
W0009-710-M10	M10 100-110mm	1/10
W0009-710-M14	M14 110-125mm	1/10



Max Disc Diameter: 100-110mm  
No Load Speed: 10500r/min

ITEM NO.	SPECS.	BOX(CTN/PCS)
W0009-1100	M10 115mm	1/10



Max Disc Diameter: 100-110mm  
No Load Speed: 10800r/min

ITEM NO.	SPECS.	BOX(CTN/PCS)
W0025	M10 100-115mm	1/10

### Cut-off machine

Cutting wheel disc size: 355mm  
No-load speed: 3800rpm  
Amperate: 15A

**W0019-355**  
**W0020-355**

2000W



Cutting capacity:  
ø25mm

ITEM NO.	RATED POWER	BOX(CTN/PCS)
W0019-355	2000W	-/1

2200W



Cutting capacity:  
ø35mm

ITEM NO.	RATED POWER	BOX(CTN/PCS)
W0020-355	2200W	-/1

### Miter Saw

Rated Voltage: 110/220V  
Rated Frequency: 50/60Hz

**W0028**  
**1600W**

Max cutting capacity at 90° :75x120mm(HxW)  
at 45° :75x80mm(HxW)

No Load Speed: 5000r/min  
Blade Diameter: 255mm



Gear drive

ITEM NO.	RATED POWER	BOX(CTN/PCS)
W0028	1600W	-/1

### Marble cutter

Input Power: 220V~240V~  
Rated Frequency: 50Hz/60Hz

**W0010**



Saw blade diameter: Ø110mm  
Cutting depth: 34mm  
No Load speed: 12000r/min

1260W

ITEM NO.	BOX(CTN/PCS)
W0010	1/6

### Circular saw

Input Power: 220V~240V~  
Rated Frequency: 50Hz/60Hz

**W0027**



Rated power: 1380W / 1800W / 2400W  
Blade diameter: 185mm / 235mm / 305mm  
No-load speed: 5300r/min

ITEM NO.	BLADE SIZE	BOX(CTN/PCS)
W0027-07	185mm/7"	1/4
W0027-09	235mm/9"	1/4
W0027-12	305mm/12"	1/4

### Jia saw

Input Power: 220V~240V~  
Rated Frequency: 50Hz/60Hz

**W0037**



No load speed: 0-3000r/min  
Max cutting capacity: 65mm

710W

ITEM NO.	RATED POWER	BOX(CTN/PCS)
W0037	710W	1/-

### CORDLESS IMPACT WRENCH

**W0014-Pro**

1/2"DR.



ITEM NO.	BOX(CTN/PCS)
W0014-Pro	1/4

### Portable blower

Input Power: 220V~240V~  
Rated Frequency: 50Hz/60Hz

**W0030B**

With speed control



No load speed: 13000r/min  
Blowing rate: 2.3m³/min

600W

ITEM NO.	RATED POWER	BOX(CTN/PCS)
W0030B	600W	1/12

### Drywall Sander

Input Power: 220V~240V~  
Rated Frequency: 50Hz/60Hz

**W0045**

No-load Speed: 1000-2100 rpm

Abrasive pad size: 210mm

Abrasive paper size: 215mm

Short-length (without extension tube): 150cm

Long-length (with extension tube): 230cm

880W



ITEM NO.	RATED POWER	BOX(CTN/PCS)
W0045	880W	-/1

### Drywall Sander

Input Power: 220V~240V~  
Rated Frequency: 50Hz/60Hz

**W0044**



900W

No-load Speed:1400-2700 rpm

Abrasive pad size::180mm

Abrasive paper size:180mm

Insulation class: Class II

ITEM NO.	RATED POWER	BOX(CTN/PCS)
W0044	900W	1/-



### LITHIUM-POWERED Cordless drill

W0012B W0013B

#### 12V

230V-50Hz  
Li-ion 12V d.c. 2000mAh  
No-load speed: 0-350 / 0-1350rpm  
Max chuck capacity: Ø10mm  
Keyless Chuck LED Light  
Max torque: 21-25N.m  
Drill capacity: Steel Ø10mm  
Wood Ø22mm  
Charge time: 1-3 hour charger



ITEM NO.	BATTERY SPECS.	BOX(CTN/PCS)
W0012B	12V 2000mAh	1/10

#### 20V

230V-50Hz  
Li-ion 20V d.c. 1300mAh  
No-load speed: 0-450 / 0-1450rpm  
Max chuck capacity: Ø10mm  
Keyless Chuck LED Light  
Max torque: 40N.m  
Drill capacity: Steel Ø10mm  
Wood Ø22mm  
Charge time: 1.5 hour charger



ITEM NO.	BATTERY SPECS.	BOX(CTN/PCS)
W0013B	20V 1300mAh	1/10

### Battery | Charger

W0012BD  
2000mAh



W0012BP



W0013BD  
1300mAh



W0013BP



### LITHIUM-POWERED Cordless drill

W0022 W0023

#### 12V

Capacity:1400mA Li-ion  
Drill in steel / wood: Ø10 / 15mm  
No load speed: 0-400/1300rpm  
Charge time: 1 hour quick charger  
Selected durable motor  
Max Torque :24N.M



INCLUDES: ONE BLOW MOLD CASE, ONE CHARGER, TWO BATTERIES

ITEM NO.	BATTERY SPECS.	BOX(CTN/PCS)
W0022	12V 1400mAh	1/10

#### 20V

Capacity:1500mA Li-ion  
Drill in steel / wood: Ø10mm  
No load speed: 0-400/1500rpm  
Charge time: 1 hour quick charger  
Selected durable motor  
Max Torque :28N.M



INCLUDES: ONE BLOW MOLD CASE, ONE CHARGER, TWO BATTERIES

ITEM NO.	BATTERY SPECS.	BOX(CTN/PCS)
W0023	20V 1500mAh	1/10

### Battery | Charger

W0022D  
1400mAh



W0022P



W0023D  
1500mAh



W0023P



### Impact socket wrench

W0014 W0014B

#### 21V

230V-50Hz  
Li-ion 21V d.c. 4000mAh  
No-load speed: 0-2400rpm  
Max torque: 150Nm Chuck: 1/2"  
Motor: Brushless Motor  
Charge time: 1 hour quick charger  
Switch: forward & reverse



1/2"DR.

ITEM NO.	BATTERY SPECS.	BOX(CTN/PCS)
W0014	21V 4000mAh	1/10

#### 21V

230V-50Hz  
Li-ion 21V d.c. 3000mAh / 4000mAh  
No-load speed: 0-3200rpm  
Max torque: 350Nm Chuck: 1/2"  
Motor: Brushless Motor  
Charge time: 2 hour quick charger  
Switch: forward & reverse



1/2"DR.

ITEM NO.	BATTERY SPECS.	BOX(CTN/PCS)
W0014B-3.0	21V 3000mAh	1/10
W0014B-4.0	21V 4000mAh	1/10

### Battery | Charger

W0014D  
3000mAh / 4000mAh



W0014P



### LITHIUM-POWERED Cordless drill

Battery capacity:

1.5, 2.0, 3.0, 4.0Ah available

21V

W0049 W0050

Voltage: 21V

Battery capacity:

1.5, 2.0, 3.0, 4.0Ah

No-load speed: 0-450 / 0-1450min<sup>-1</sup>  
20 steps torque setting ring with fast and slow speed switch

Max chuck capacity: Ø10mm

LED Light Max torque: 30N.m

Drill capacity: Steel Ø10mm

Wood Ø22mm

Charge time: 1.5 hour charger



Brushless motor, compact size, more torque, less power consumption

ITEM NO.	BOX(CTN/PCS)
W0049	1/10

Voltage: 21V

Battery capacity:

1.5, 2.0, 3.0, 4.0Ah

No-load speed: 0-450 / 0-1450min<sup>-1</sup>

Torque: 20+3 Setting Rings

Max chuck capacity: Ø13mm

LED Light Max torque: 60N.m

Drill capacity: Steel Ø10mm

Wood Ø22mm

Charge time: 1.5 hour charger



3 functions: drill, screwdriver, impact drill  
Brushless motor, industrial metal chuck, heavy duty torque

ITEM NO.	BOX(CTN/PCS)
W0050	1/10

### LITHIUM-POWERED Pruning shears

Battery capacity:

1.5, 2.0, 3.0, 4.0Ah available

21V

W0040-25  
W0040-35

Cutting capacity:  
ø25mm

Voltage: 21V

Battery capacity : 1.5, 2.0, 3.0, 4.0Ah

Blade: SK5 steel with hardness at HRC 58-60°

Motor: Brushless

Torque: 17640 Nm

Cutting capacity: dry wood Ø20mm

fresh wood ø25mm

One quick charger  
Two batteries  
One blow mold case

ITEM NO.	BOX(CTN/PCS)
W0040-25	1/48

Cutting capacity:  
ø35mm

Voltage: 21V

Battery capacity : 1.5, 2.0, 3.0, 4.0Ah

Blade: SK5 steel with hardness at HRC 58-60°

Motor: Brushless

Torque: 24500 Nm

Cutting capacity: dry wood Ø25mm

fresh wood ø35mm

One quick charger  
Two batteries  
One blow mold case

ITEM NO.	BOX(CTN/PCS)
W0040-35	1/48



### Cordless riveters

Battery capacity:  
1.5, 2.0, 3.0, 4.0Ah available

W0035 W0036 W0029

Motor:brushless  
Screw drive transmission produces continuous torque for heavy duty performance  
Rivet size: 2.4 3.2 4.0 4.8mm aluminum rivets  
2.4 3.2mm stainless steel rivets



One quick charger Two batteries One blow mold case

ITEM NO.	BOX(CTN/PCS)
W0035	1/10

Motor:brushless  
Screw drive transmission produces continuous torque for heavy duty performance  
Rivet size: 2.4 3.2 4.0 4.8 6.4mm aluminum and stainless steel rivets



Two batteries: one 2000mAh one 4000mAh  
One quick charger One blow mold case

ITEM NO.	BOX(CTN/PCS)
W0036	1/10

Nut size:  
M3 M4 M5 M6 M8 M10 M12

Motor: brushless  
Screw drive transmission produces continuous torque for heavy duty performance



Two batteries: one 2000mAh one 4000mAh  
One quick charger One blow mold case

ITEM NO.	BOX(CTN/PCS)
W0029	1/10

### Rotary hammer

W0041

3function  
Battery voltage: 21V  
Capacity: 4000mAh Li-ion  
No Load speed: 0-950rpm  
Rated Impact: 4500rmp  
Max.drilling Capacity: ϕ26mm



**BRUSHLESS**

ITEM NO.	BATTERY SPECS.	BOX(CTN/PCS)
W0041	4000mAh	1/-

### Angle grinder

W0042

Battery voltage: 21V  
Capacity: 4000mAh Li-ion  
No load speed: 8000r/min  
Max disc diameter: ϕ100mm



**BRUSHLESS**

ITEM NO.	BATTERY SPECS.	BOX(CTN/PCS)
W0042	4000mAh	1/-

### Cordless hedge shear

W0053

Lithium battery capacity: 3.0Ah,4.0Ah available  
Charger: 1.0A 1.5A 2.0A available



Battery voltage: 21V  
Brushless motor  
No-load speed:7000rpm  
Blade length:500mm  
Max. Cutting capacity:dr.14mm

ITEM NO.	BATTERY SPECS.	BOX(CTN/PCS)
W0053	3000mAh	1/-

### Cordless tea picker

W0054

Lithium battery capacity: 3.0Ah,4.0Ah available  
Charger: 1.0A 1.5A 2.0A available



Battery voltage: 21V  
Brushless motor  
No-load speed: 7000rpm  
Effective cutting width: 300mm  
Max. Cutting capacity: dr.14mm

ITEM NO.	BATTERY SPECS.	BOX(CTN/PCS)
W0054	3000mAh	1/-

### Cordless chain saw

Lithium battery capacity: 1.5Ah, 2.0Ah, 3.0Ah, 4.0Ah available  
Charger: 0.8A, 1.0A, 1.5A, 2.0A available

W0046-04  
W0046-12  
W0046-16



Battery voltage: 21V  
Chain guide blade size:4"/100mm  
Cutting diameter:70mm

ITEM NO.	SIZE	BOX(CTN/PCS)
W0046-04	100mm/4"	1/-



Battery voltage: 21V  
Chain guide blade size:12"/300mm  
Cutting diameter: 205mm

ITEM NO.	BOX(CTN/PCS)
W0046-12	1/-



Battery voltage: 21V  
Chain guide blade size:16"/400mm  
Cutting diameter: 280mm

ITEM NO.	BOX(CTN/PCS)
W0046-16	1/-

### Cordless pressure washer

W0052

Battery voltage: 21V  
Max pressure: 20bar  
Lithium battery capacity: 3.0Ah, 4.0Ah available  
Charger: 1.0A 1.5A 2.0A available



ITEM NO.	BOX(CTN/PCS)
W0052	1/-

### Cordless air blower

W0055

Lithium battery capacity: 3.0Ah, 4.0Ah available  
Charger: 1.0A 1.5A 2.0A available



Battery Voltage: 21V  
No-load speed: 0-18000r/min  
Air volume: 1.6-2.6m<sup>3</sup>/min  
Mechanical wind: 13000r/min  
Wind pressure: 5.4KPA

ITEM NO.	BOX(CTN/PCS)
W0055	1/-

### Cordless screwdriver

W0043 W0024

#### 3.6V

Battery Li-ion 3.6V 900mAh  
Rotational Speed (No Load) 280RPM  
Torque 2N.m(Electric) 10N.m(Manual)  
Charge Rate 60 minutes  
Operating Rate 40 minutes  
USB Charger Input 5V 500mAh  
Weight 150g



ITEM NO.	BOX(CTN/PCS)
W0043	12/-

#### 4.0V

230V- 50Hz  
Battery Li-ion 4.0V 900mAh  
No-load speed: 200min  
Max torque: 4.0Nm  
Charge time:5hour



ITEM NO.	BOX(CTN/PCS)
W0024	6/12



Photo	Name	Item No.
	Rotor(Z)	W0007-Z / D
		W0007A-Z / D
		W0007C-Z / D
		W0008B-Z / D
		W0008-Z / D
		W0009-Z / D
		W0009-700-Z / D
		W0009-710-Z / D
		W0009-110-Z / D
		W0025-Z / D
	Stator(D)	W0010-Z / D
		W0011-20-Z / D
		W0011-24-Z / D
		W0011-26-Z / D
		W0018-1200-Z / D
		W0018-1500-Z / D
		W0019-Z / D
		W0020-Z / D

Photo	Name	Item No.
	碳刷付	W0007-TS
		W0007A-TS
		W0007C-TS
		W0008B-TS
		W0008-TS
		W0009-TS
		W0009-700-TS
		W0009-710-TS
		W0009-1100-TS
		W0025-TS
		W0010-TS
		W0011-20-TS
		W0011-24-TS
		W0011-26-TS
		W0018-1200-TS



Photo	Name	Item No.
	Motor	C0043-P
		C0044-P
		C0045-P
		C0049-P
		C0431-P

Photo	Name	Item No.
	Switch/circuit board	C0043-XLB
		C0044-XLB
		C0045-XLB
		C0049-XLB
		C0431-XLB

Battery photo	Battery capacity	Item No.	Applicable batteries	Charger	Output	Item No.	Applicable batteries
	1.5A	MB211500	W0041		1.0A	MC2110	MB211500
			W0042		1.5A		
			W0052		(available)		
			W0040				
			W0035				
	2.0A	MB212000	W0036				
			W0029				
			W0049				
			W0050		2.0A	MC2120	MB214000
			W0046-04				
3.0A	MB213000	W0046-12		 <p>1.Connected by cable 2.Greatly reduces the weight of battery powered tools 3.Compatible with Makita type batteries 4.USB Output</p>			
		W0046-16					
		W0053					
		W0054					
		W0014-Pro					
4.0A	MB214000	W0055					
		(available)					

### Multi-washer high pressure | W0033 W0034

Rated voltage: 220-240V | Rated frequency: 50Hz

<p>Input power: 1300W Working pressure: 70Bar Flow capacity: 360L/H Max pressure: 105Bar M.R.P ( Rs ) : 2800 Gross weight:13Kgs</p> 	<p>Input power: 1500W Working pressure: 90Bar Flow capacity: 360L/H Max pressure: 130Bar M.R.P ( Rs ) : 2800 Gross weight:15Kgs</p> 	<p>Rated voltage: 220-240V Rated frequency: 50Hz Input power: 1500W Working pressure: 8.0Bar</p> <p>Flow capacity: 10L/H Max pressure: 1100psi M.R.P ( Rs ) : 2800 Gross weight:11Kgs</p> 																		
<table border="1"> <tr><th>ITEM NO.</th><th>SIZE</th><th>BOX(CTN/PCS)</th></tr> <tr><td>W0033</td><td>1300W</td><td>1/-</td></tr> </table>	ITEM NO.	SIZE	BOX(CTN/PCS)	W0033	1300W	1/-	<table border="1"> <tr><th>ITEM NO.</th><th>SIZE</th><th>BOX(CTN/PCS)</th></tr> <tr><td>W0034</td><td>1500W</td><td>1/-</td></tr> </table>	ITEM NO.	SIZE	BOX(CTN/PCS)	W0034	1500W	1/-	<table border="1"> <tr><th>ITEM NO.</th><th>SIZE</th><th>BOX(CTN/PCS)</th></tr> <tr><td>W0026</td><td>1500W</td><td>1/-</td></tr> </table>	ITEM NO.	SIZE	BOX(CTN/PCS)	W0026	1500W	1/-
ITEM NO.	SIZE	BOX(CTN/PCS)																		
W0033	1300W	1/-																		
ITEM NO.	SIZE	BOX(CTN/PCS)																		
W0034	1500W	1/-																		
ITEM NO.	SIZE	BOX(CTN/PCS)																		
W0026	1500W	1/-																		

### Welding machine | W0017B-160 W0017B-200 W0017B-250

Input voltage: 220V ± 15% | No-Load voltage: 65 ± 5V | Power factor: 0.8 | Duty-cycle: 60%

Insulation class: IP21S | Protection: F | Diameter: 1.6-3.2

<p>Rated output current: 20-160A Rated output voltage: 24.8V Rated input power capacity: 3.5KW Rated input current: 16A</p> 	<p>Rated output current: 20-200A Rated output voltage: 25.6V Rated input power capacity: 4.2KW Rated input current: 19A</p> 	<p>Rated output current: 20-250A Rated output voltage: 26.4V Rated input power capacity: 5KW Rated input current: 22.7A</p> 																		
<table border="1"> <tr><th>ITEM NO.</th><th>SIZE</th><th>BOX(CTN/PCS)</th></tr> <tr><td>W0017B-160</td><td>160A</td><td>1/4</td></tr> </table>	ITEM NO.	SIZE	BOX(CTN/PCS)	W0017B-160	160A	1/4	<table border="1"> <tr><th>ITEM NO.</th><th>SIZE</th><th>BOX(CTN/PCS)</th></tr> <tr><td>W0017B-200</td><td>200A</td><td>1/3</td></tr> </table>	ITEM NO.	SIZE	BOX(CTN/PCS)	W0017B-200	200A	1/3	<table border="1"> <tr><th>ITEM NO.</th><th>SIZE</th><th>BOX(CTN/PCS)</th></tr> <tr><td>W0017B-250</td><td>250A</td><td>1/2</td></tr> </table>	ITEM NO.	SIZE	BOX(CTN/PCS)	W0017B-250	250A	1/2
ITEM NO.	SIZE	BOX(CTN/PCS)																		
W0017B-160	160A	1/4																		
ITEM NO.	SIZE	BOX(CTN/PCS)																		
W0017B-200	200A	1/3																		
ITEM NO.	SIZE	BOX(CTN/PCS)																		
W0017B-250	250A	1/2																		

### Electrode holder | B0009-300 B0009-500

<p>Diameter of electrode: 3.2-6.4mm Maximum cable size: 50mm<sup>2</sup></p> 	<p>Diameter of electrode: 5.0-8.0mm Maximum cable size: 80mm<sup>2</sup></p> 												
<table border="1"> <tr><th>ITEM NO.</th><th>SIZE</th><th>BOX(CTN/PCS)</th></tr> <tr><td>B0009-300</td><td>300A</td><td>1/48</td></tr> </table>	ITEM NO.	SIZE	BOX(CTN/PCS)	B0009-300	300A	1/48	<table border="1"> <tr><th>ITEM NO.</th><th>SIZE</th><th>BOX(CTN/PCS)</th></tr> <tr><td>B0009-500</td><td>500A</td><td>1/48</td></tr> </table>	ITEM NO.	SIZE	BOX(CTN/PCS)	B0009-500	500A	1/48
ITEM NO.	SIZE	BOX(CTN/PCS)											
B0009-300	300A	1/48											
ITEM NO.	SIZE	BOX(CTN/PCS)											
B0009-500	500A	1/48											



**Pneumatic socket wrench**

W0001  
W0002 | 1/2"DR.

Twin hammer mechanism for steady and potent performance  
Easy adjustable power regulator  
Axle made of carbon steel drop-forged and heat treated  
Handle exhaust  
Ideal for changing tires, assembling work and other workshop applications



ITEM NO.	SIZE	BOX(CTN/PCS)
W0001	plastic box	1/5

Twin hammer mechanism for steady and potent performance  
Easy adjustable power regulator  
Axle made of carbon steel drop-forged and heat treated  
Front exhaust  
Ideal for changing tires, assembling work and other workshop applications



ITEM NO.	SIZE	BOX(CTN/PCS)
W0002		1/10

**Pneumatic riveting gun**

W0004



ITEM NO.	BOX(CTN/PCS)
W0004	1/10

**Spray gun**

Nozzle: stainless steel  
Air cap: brass  
Clamp: aluminum

W-71G W-77G  
W-71S W-77S



ITEM NO.	SIZE	BOX(CTN/PCS)
W-71G	400cc	1/20
W-71S	600cc	1/20



ITEM NO.	SIZE	BOX(CTN/PCS)
W-77G	400cc	1/20
W-77S	1000cc	1/10

**Air screwdriver**

W0003  
W0003B



ITEM NO.	SIZE	BOX(CTN/PCS)
W0003	10500r.p.m.	1/30
W0003B	10500r.p.m.	1/30

**Aluminium air duster**

L0012  
L0012A



ITEM NO.	SIZE	BOX(CTN/PCS)
L0012-12	12mm	12/120
L0012-80	80mm	12/120
L0012A-80	80mm	12/120

**Air duster gun**

L0010  
L0011

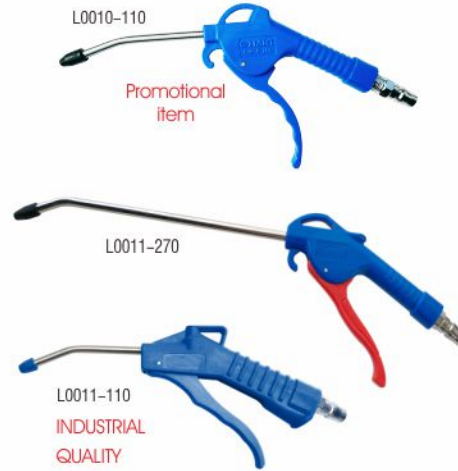

ITEM NO.	SIZE	BOX(CTN/PCS)
L0010-110	110mm	10/100
L0011-110	110mm	10/100
L0011-270	270mm	10/100

**Air pump**

S0024  
S0025



ITEM NO.	SIZE	BOX(CTN/PCS)
S0024		1/4
S0025		1/-



**Power Tool Accessories & Consumables**

**Diamond cutting wheel**

A0079  
A0080  
A0081

A0181  
A0181B  
A0183

A0082-105  
A0082-114  
A0182 A0087

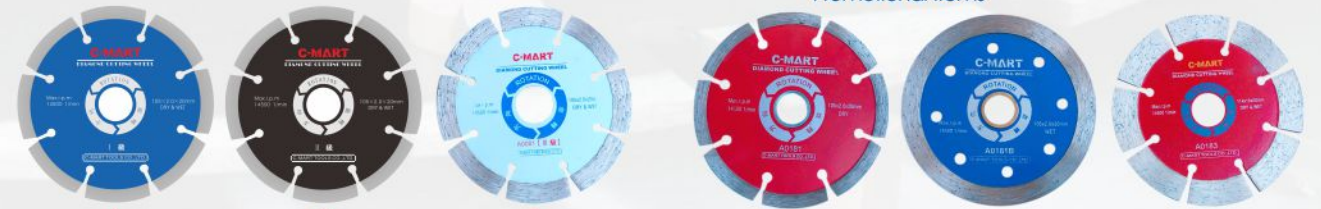

ITEM NO.	SIZE	BOX(CTN/PCS)
A0079	I 105x2.0x20mm	24/144
A0080	II 105x2.0x20mm	24/144
A0081	III 105x2.0x20mm	24/144

ITEM NO.	SIZE	BOX(CTN/PCS)
A0181	105x2.0x20mm	24/144
A0181B	105x1.2x20mm	24/144
A0183	114x1.5x20mm	24/144

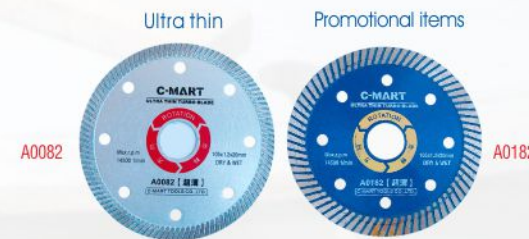

ITEM NO.	SIZE	BOX(CTN/PCS)
A0082-105	105x1.2x20mm	24/144
A0082-114	114x1.2x20mm	24/144
A0182	105x1.2x20mm	24/144



ITEM NO.	SIZE	BOX(CTN/PCS)
A0087	115x1.2x20mm 3-pc set	25/50



**Abrasive cutting wheel**

**A0083  
A0084**



ITEM NO.	SIZE	BOX(CTN/PCS)
A0083-04-1.2	105x1.2x16mm/4"	20/800
A0083-04-2.0	105x2.0x16mm/4"	-/400
A0083-12	305mm/12"	-/25
A0083-14	355mm/14"	-/25
A0083-16	405mm/16"	-/25



ITEM NO.	SIZE	BOX(CTN/PCS)
A0084-04-1.0	105x1.0x16mm/4"	20/800
A0084-04-2.0	105x2.0x16mm/4"	-/400
A0084-12	305mm/12"	-/25
A0084-14	355mm/14"	-/25
A0084-16	405mm/16"	-/25

**Abrasive cutting wheel for stainless steel**

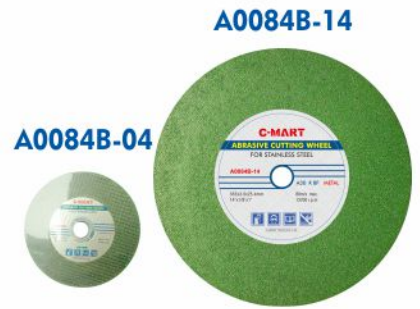

ITEM NO.	SIZE	BOX(CTN/PCS)
A0084B-04	100mm/4"	20/800
A0084B-14	355mm/14"	30/-

**Tungsten carbide tipped saw blade for wood**

**A0086**

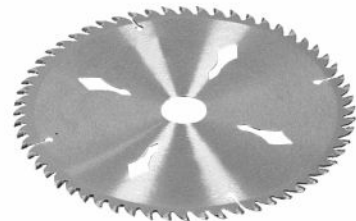

ITEM NO.	SIZE	BOX(CTN/PCS)	ITEM NO.	SIZE	BOX(CTN/PCS)
A0086-11024	110x24T	-/200	A0086-25440	254x40T	1/30
A0086-11030	110x30T	-/200	A0086-25460	254x60T	1/30
A0086-11040	110x40T	-/200	A0086-25480	254x80T	1/30
A0086-18524	185x24T	1/50	A0086-30540	305x40T	1/20
A0086-18540	185x40T	1/50	A0086-30560	305x60T	1/20
A0086-18560	185x60T	1/50	A0086-30580	305x80T	1/20
A0086-23030	230x30T	1/50	A0086-35540	355x40T	1/20
A0086-23040	230x40T	1/50	A0086-35560	355x60T	1/20
A0086-23060	230x60T	1/50	A0086-35572	355x72T	1/20
A0086-23080	230x80T	1/50	A0086-35580	355x80T	1/20
A0086-25430	254x30T	1/50	A0086-355100	355x100T	1/20

**Tungsten carbide tipped saw blade for aluminum**

**A0085**



ITEM NO.	SIZE	BOX(CTN/PCS)
A0085-11030	110mm 30T	-/100
A0085-11040	110mm 40T	-/100
A0085-25480	254mm 80T	-/20
A0085-254100	254mm 100T	-/20

**Hss straight shank twist drills**

**A0100**



Made of high speed steel, titanium coated

ITEM NO.	SIZE	REMARKS
A0100-0.5	0.5mm	No coating
A0100-0.6	0.6mm	No coating
A0100-0.7	0.7mm	No coating
A0100-0.8	0.8mm	No coating
A0100-0.9	0.9mm	No coating
A0100	1.0-13.5	coating

**High speed twist drills**

**A0200**



Dual coloured, rolled

ITEM NO.	SIZE
A0200	1-13mm

**Hss straight shank twist drill set**

**A0100A / B / C**

A0100A  
1.5 2.0 2.5 3.0 3.2 3.5 4.0 4.5  
4.8 5.0 5.5 6.0 6.5

A0100B  
1.0 1.5 2.0 2.5 3.0 3.5 4.0 4.5  
5.0 5.5 6.0 6.5 7.0 7.5 8.0 8.5  
9.0 9.5 10.0 10.5 11.0 11.5  
12.0 12.5 13.0

A0100C  
1.0 1.5 2.0 2.5 3.0 3.5 4.0 4.5  
5.0 5.5 6.0 6.5 7.0 7.5 8.0 8.5  
9.0 9.5 10.0

ITEM NO.	SIZE	BOX(CTN/PCS)
A0100A	13pc set	1/50
A0100B	25pc set	1/10
A0100C	19pc set	1/20



**Hammer drills**

**A0098**



ITEM NO.	SIZE	ITEM NO.	SIZE
A0098-06110	6x110mm	A0098-18350	18x350mm
A0098-08110	8x110mm	A0098-20350	20x350mm
A0098-10110	10x110mm	A0098-22350	22x350mm
A0098-06150	6x150mm	A0098-25350	25x350mm
A0098-08150	8x150mm	A0098-1/4-110	1/4"x110mm
A0098-10150	10x150mm	A0098-5/16-110	5/16"x110mm
A0098-12150	12x150mm	A0098-3/8-110	3/8"x110mm
A0098-14150	14x150mm	A0098-1/4-150	1/4"x150mm
A0098-16150	16x150mm	A0098-5/16-150	5/16"x150mm
A0098-10300	10x300mm	A0098-3/8-150	3/8"x150mm
A0098-12350	12x350mm	A0098-1/2-150	1/2"x150mm
A0098-14350	14x350mm	A0098-9/16-150	9/16"x150mm
A0098-16350	16x350mm	A0098-5/8-150	5/8"x150mm

**Masonry drills**

**A0097**



ITEM NO.	SIZE	BOX(CTN/PCS)
A0097-06300	6x300mm	
A0097-08300	8x300mm	
A0097-10300	10x300mm	
A0097-12300	12x300mm	
A0097	4.0-10.0mm	

**Taper shank twist drills**

**A0099**

**CR-V.**



ITEM NO.	SIZE	ITEM NO.	SIZE	ITEM NO.	SIZE	ITEM NO.	SIZE	ITEM NO.	SIZE
A0099-13.5	13.5mm	A0099-22.5	22.5mm	A0099-31.5	31.5mm	A0099-40.5	40.5mm	A0099-49.5	49.5mm
A0099-14.0	14.0mm	A0099-23.0	23.0mm	A0099-32.0	32.0mm	A0099-41.0	41.0mm	A0099-50.0	50.0mm
A0099-14.5	14.5mm	A0099-23.5	23.5mm	A0099-32.5	32.5mm	A0099-41.5	41.5mm	A0099-51.0	51.0mm
A0099-15.0	15.0mm	A0099-24.0	24.0mm	A0099-33.0	33.0mm	A0099-42.0	42.0mm	A0099-52.0	52.0mm
A0099-15.5	15.5mm	A0099-24.5	24.5mm	A0099-33.5	33.5mm	A0099-42.5	42.5mm	A0099-53.0	53.0mm
A0099-16.0	16.0mm	A0099-25.0	25.0mm	A0099-34.0	34.0mm	A0099-43.0	43.0mm	A0099-54.0	54.0mm
A0099-16.5	16.5mm	A0099-25.5	25.5mm	A0099-34.5	34.5mm	A0099-43.5	43.5mm	A0099-55.0	55.0mm
A0099-17.0	17.0mm	A0099-26.0	26.0mm	A0099-35.0	35.0mm	A0099-44.0	44.0mm	A0099-56.0	56.0mm
A0099-17.5	17.5mm	A0099-26.5	26.5mm	A0099-35.5	35.5mm	A0099-44.5	44.5mm	A0099-57.0	57.0mm
A0099-18.0	18.0mm	A0099-27.0	27.0mm	A0099-36.0	36.0mm	A0099-45.0	45.0mm	A0099-58.0	58.0mm
A0099-18.5	18.5mm	A0099-27.5	27.5mm	A0099-36.5	36.5mm	A0099-45.5	45.5mm	A0099-59.0	59.0mm
A0099-19.0	19.0mm	A0099-28.0	28.0mm	A0099-37.0	37.0mm	A0099-46.0	46.0mm	A0099-60.0	60.0mm
A0099-19.5	19.5mm	A0099-28.5	28.5mm	A0099-37.5	37.5mm	A0099-46.5	46.5mm	A0099-61.0	61.0mm
A0099-20.0	20.0mm	A0099-29.0	29.0mm	A0099-38.0	38.0mm	A0099-47.0	47.0mm	A0099-62.0	62.0mm
A0099-20.5	20.5mm	A0099-29.5	29.5mm	A0099-38.5	38.5mm	A0099-47.5	47.5mm	A0099-63.0	63.0mm
A0099-21.0	21.0mm	A0099-30.0	30.0mm	A0099-39.0	39.0mm	A0099-48.0	48.0mm	A0099-64.0	64.0mm
A0099-21.5	21.5mm	A0099-30.5	30.5mm	A0099-39.5	39.5mm	A0099-48.5	48.5mm	A0099-65.0	65.0mm
A0099-22.0	22.0mm	A0099-31.0	31.0mm	A0099-40.0	40.0mm	A0099-49.0	49.0mm		

**Hammer chisel-flat**

**A0981 | CR-V.**



ITEM NO.	SIZE	BOX(CTN/PCS)
A0981-14	14x250mm	12/72
A0981-17	17x250mm	12/72

**Hammer chisel-pointed**

**A0982 | CR-V.**



ITEM NO.	SIZE	BOX(CTN/PCS)
A0982-14	14x250mm	12/72
A0982-17	17x250mm	12/72

**Hss solid ground machine taps**

**A1100**



ITEM NO.	SIZE	BOX(CTN/PCS)
A1100-2.0	M2.0	10/-
A1100-2.5	M2.5	10/-
A1100-03	M3.0	10/-
A1100-04	M4.0	10/-
A1100-05	M5.0	10/-
A1100-06	M6.0	10/-
A1100-08	M8.0	10/-
A1100-10	M10.0	5/-
A1100-12	M12.0	5/-



**Woodwork drill bit set**

**A0118-05**  
**A0118-08**

**5PC SET**

4mm 5mm 6mm  
5/32" 3/16" 1/4"  
8mm 10mm  
5/16" 3/8"



**8PC SET**

3mm 4mm 5mm 6mm  
1/8" 5/32" 3/16" 1/4"  
7mm 8mm 9mm 10mm  
9/32" 5/16" 11/32" 3/8"



ITEM NO.	SIZE	BOX(CTN/SETS)
A0118-05	5-pc set	20/100

ITEM NO.	SIZE	BOX(CTN/SETS)
A0118-08	8-pc set	10/100

**Masonry drill bit set**

**A0119-05**  
**A0119-08**

**5PC SET**

4mm 5mm 6mm  
5/32" 3/16" 1/4"  
8mm 10mm  
5/16" 3/8"



**8PC SET**

3mm 4mm 5mm 6mm  
1/8" 5/32" 3/16" 1/4"  
7mm 8mm 9mm 10mm  
9/32" 5/16" 11/32" 3/8"



ITEM NO.	SIZE	BOX(CTN/SETS)
A0119-05	5-pc set	20/100

ITEM NO.	SIZE	BOX(CTN/SETS)
A0119-08	8-pc set	10/100

**Ajdustable hole cutter**  
**A0109**

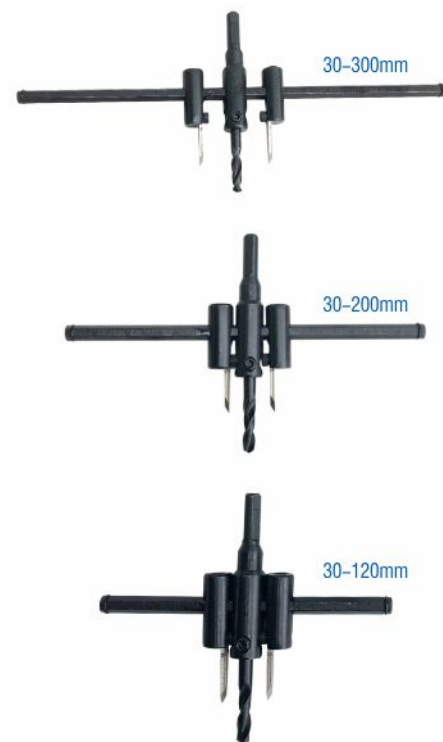

Alloy steel cutter blades heat treated  
Whole set includes one adjustable hole cutter drill, one 6mm hex key wrench and one plain brad point drill  
Use after tightly fixing cutting blade screws with attached hex key wrench  
Do not drill metal  
Suitable for none metal board such as plywood and plasterboard

ITEM NO.	SIZE	BOX(CTN/PCS)
A0109-30300	30-300mm	-
A0109-30200	30-200mm	-
A0109-30120	30-120mm	-

**Sorted drill bit set**

**A0120-09**    **A0120-16**

**9PC SET**

5mm 6mm 8mm  
3/16" 1/4" 5/16"  
5mm 6mm 8mm  
3/16" 1/4" 5/16"  
5mm 6mm 8mm  
3/16" 1/4" 5/16"



**16PC SET**

2mm 3mm 4mm 5mm  
5/64" 1/8" 5/32" 3/16"  
6mm 8mm  
1/4" 5/16"  
4mm 5mm 6mm 8mm  
5/32" 3/16" 1/4" 5/16"  
10mm 4mm 5mm  
3/8" 5/32" 3/16"  
6mm 8mm 10mm  
1/4" 5/16" 3/8"



ITEM NO.	SIZE	BOX(CTN/SETS)
A0120-09	9-pc set	10/100

ITEM NO.	SIZE	BOX(CTN/SETS)
A0120-16	16-pc set	10/40

**Hole saw set (for wood)**

**A0110**    **A0111**    **A0112**



Hole saw size:  
64mm 76mm 89mm  
102mm 127mm

ITEM NO.	SIZE	BOX(CTN/PCS)
A0110	8-pc set	1/20



Hole saw size: 19mm 22mm 29mm 32mm 38mm  
44mm 51mm 64mm

ITEM NO.	SIZE	BOX(CTN/PCS)
A0111	11-pc set	1/30

12 pieces of hole saws sizes:  
19.22.29.32.38.44.51.64.76.  
89.102.127mm  
1 3/8" mandrel

1 1/4" drill bit(2' long)  
with mandrel  
1 drive plate  
1 hex wrench  
1 blow molded storage case



ITEM NO.	SIZE	BOX(CTN/PCS)
A0112	16-pc set	1/20

**Lock installation kit**

**A0102**  
**A0103**



ITEM NO.	SIZE	BOX(CTN/PCS)
A0102-28	28.8mm	2-1/8" 10/60
A0102-45	45mm	2-1/8" 10/60



ITEM NO.	SIZE	BOX(CTN/PCS)
A0103	2-1/8"	6/60

**TCT hole saw**  
For metal

**A2103**



ITEM NO.	SIZE	BOX(CTN/PCS)
A2103	Ø14 - Ø23.5mm	10/300
A2103	Ø24 - Ø28mm	10/300
A2103	Ø30 - Ø40mm	10/180
A2103	Ø42 - Ø55mm	10/72
A2103	Ø60 - Ø63mm	1/72
A2103	Ø65 - Ø75mm	1/48
A2103	Ø80 - Ø100mm	1/36
A2103	Ø105 - Ø125mm	1/24

**Ceramic/Glass drills**

**A3104**

Ceramic, glass, wood



ITEM NO.	SIZE	BOX(CTN/PCS)
A3104-06	6mm	100/-
A3104-08	8mm	50/-
A3104-10	10mm	25/-
A3104-12	12mm	25/-

**Multi-purpose drills**

**A3105**

Ceramic, glass, wood, metal, cement



ITEM NO.	SIZE	BOX(CTN/PCS)
A3105-06	6mm	100/-
A3105-08	8mm	50/-
A3105-10	10mm	25/-
A3105-12	12mm	25/-



TCT hole saw (for glass) | A3103



ITEM NO.	SIZE	BOX(CTN/PCS)	ITEM NO.	SIZE	BOX(CTN/PCS)	ITEM NO.	SIZE	BOX(CTN/PCS)
A3103-06	6mm	10/360/3600	A3103-28	28mm	5/40/480	A3103-65	65mm	2/126
A3103-08	8mm	10/230/2760	A3103-30	30mm	2/20/240	A3103-70	70mm	2/100
A3103-10	10mm	10/200/2400	A3103-32	32mm	2/20/240	A3103-75	75mm	2/72
A3103-12	12mm	5/75/900	A3103-34	34mm	2/20/240	A3103-80	80mm	2/72
A3103-14	14mm	5/70/840	A3103-35	35mm	2/20/240	A3103-85	85mm	2/60
A3103-16	16mm	5/60/720	A3103-38	38mm	2/16/192	A3103-90	90mm	2/60
A3103-18	18mm	5/55/660	A3103-40	40mm	2/16/192	A3103-95	95mm	2/50
A3103-20	20mm	5/50/600	A3103-42	42mm	2/12/144	A3103-100	100mm	2/50
A3103-21	21mm	5/45/540	A3103-45	45mm	2/12/144	A3103-105	105mm	2/30
A3103-22	22mm	5/45/540	A3103-48	48mm	2/12/144	A3103-110	110mm	2/30
A3103-24	24mm	5/40/480	A3103-50	50mm	2/12/144	A3103-115	115mm	2/30
A3103-25	25mm	5/40/480	A3103-55	55mm	2/12/144	A3103-120	120mm	2/30
A3103-27	27mm	5/40/480	A3103-60	60mm	2/126	A3103-125	125mm	2/30

Hinge boring drill bit | A0197-35



ITEM NO.	SIZE	BOX(CTN/PCS)
A0197-35	35mm	10/200

Super strong magnetic bits | C0407-PH2-65 C0408-PH2-65

10+1



King size magnetic ring to hold nuts and screws firm and tight  
Bits made of S2 steel from Taiwan HRC58-62°  
Suitabel for DIY and industrial use

ITEM NO.	SIZE	BOX(CTN/PCS)
C0407-PH2-65	PH2-65mm	-

10+10



Each bit is equipped with a magnet ring to hold nuts and screws firm and tight  
Bits made of S2 steel from Taiwan HRC58-62°  
Suitabel for DIY and industrial use

ITEM NO.	SIZE	BOX(CTN/PCS)
C0408-PH2-65	PH2-65mm	-

Double end bits-phillips | C0040 C0040B C0040C | 1/4"DR.

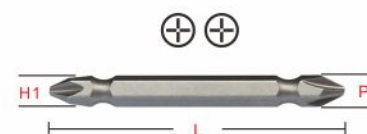

ITEM NO.	H1	PH	L
C0040-PH1-65	6.35mm--1/4"	PH1	65mm
C0040-PH1-100	6.35mm--1/4"	PH1	100mm
C0040-PH1.5-65	6.35mm--1/4"	PH1.5	65mm
C0040-PH2-65	6.35mm--1/4"	PH2	65mm
C0040-PH3-65	6.35mm--1/4"	PH3	65mm
C0040-PH2-100	6.35mm--1/4"	PH2	100mm
C0040-PH2-150	6.35mm--1/4"	PH2	150mm



ITEM NO.	H1	PH	L
C0040B-PH1-65	6.35mm--1/4"	PH1	65mm
C0040B-PH2-65	6.35mm--1/4"	PH2	65mm
C0040B-PH1-110	6.35mm--1/4"	PH1	100mm
C0040B-PH2-110	6.35mm--1/4"	PH2	100mm



ITEM NO.	H1	PH	L
C0040C-PH1-65	6.35mm--1/4"	PH1	65mm
C0040C-PH2-65	6.35mm--1/4"	PH2	65mm

Single end bits-hex | C0401 | 1/4"DR.

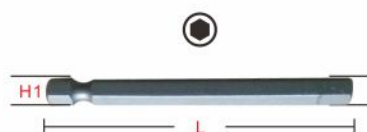

ITEM NO.	H1	PH	L
C0401-H3-50	6.35mm--1/4"	H3	50mm
C0401-H4-50	6.35mm--1/4"	H4	50mm
C0401-H5-50	6.35mm--1/4"	H5	50mm
C0401-H6-50	6.35mm--1/4"	H6	50mm
C0401-H2.5-50	6.35mm--1/4"	H2.5	50mm

Single end bits-torx | C0402 | 1/4"DR.



ITEM NO.	H1	PH	L
C0402-T10-50	6.35mm--1/4"	T10	50mm
C0402-T15-50	6.35mm--1/4"	T15	50mm
C0402-T20-50	6.35mm--1/4"	T20	50mm
C0402-T25-50	6.35mm--1/4"	T25	50mm
C0402-T30-50	6.35mm--1/4"	T30	50mm

Single end bits-phillips | C0403 | 1/4"DR.



ITEM NO.	H1	PH	Ø	L
C0403-PH1-3.0	6.35mm--1/4"	PH1	Ø3.0	50mm
C0403-PH1-4.5	6.35mm--1/4"	PH1	Ø4.5	50mm
C0403-PH2-4.5	6.35mm--1/4"	PH2	Ø4.5	50mm
C0403-PH2-6.0	6.35mm--1/4"	PH2	Ø6.0	50mm

Phillips | C0404 C0405 C0406 | ⊕



ITEM NO.	Ø	Ø1	PH	L
C0404-PH0-1.6	Ø4	Ø1.6	PH00	40mm
C0404-PH0-2.0	Ø4	Ø2.0	PH0	40mm
C0404-PH0-2.5	Ø4	Ø2.5	PH0	40mm
C0404-PH1-3.0	Ø4	Ø3.0	PH1	40mm
C0404-PH2-4.0	Ø4	Ø4.0	PH2	40mm

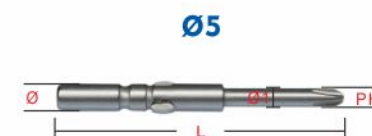

ITEM NO.	Ø	Ø1	PH	L
C0405-PH0-1.6	Ø5	Ø1.6	PH00	50mm
C0405-PH0-2.0	Ø5	Ø2.0	PH0	50mm
C0405-PH0-2.5	Ø5	Ø2.5	PH0	50mm
C0405-PH1-3.0	Ø5	Ø3.0	PH1	50mm
C0405-PH1-4.0	Ø5	Ø4.0	PH1	50mm
C0405-PH2-4.0	Ø5	Ø4.0	PH2	50mm
C0405-PH2-5.0	Ø5	Ø5.0	PH2	50mm



ITEM NO.	Ø	Ø1	PH	L
C0406-PH0-2.0	Ø6	Ø1.6	PH0	60mm
C0406-PH1-3.0	Ø6	Ø2.0	PH1	60mm
C0406-PH1-4.0	Ø6	Ø2.5	PH1	60mm
C0406-PH2-4.0	Ø6	Ø3.0	PH2	60mm
C0406-PH2-5.0	Ø6	Ø4.0	PH2	60mm
C0406-PH2-6.0	Ø6	Ø4.0	PH2	60mm





# WRENCHES AND SOCKETS

## F / T Series

### Double open-end wrench | F0003



ITEM NO.	SIZE	BOX(CTN/PCS)	ITEM NO.	SIZE	BOX(CTN/PCS)
F0003-0607	6x7mm	12/144	F0003-1719	17x19mm	12/120
F0003-0810	8x10mm	12/144	F0003-1921	19x21mm	6/36
F0003-1012	10x12mm	12/144	F0003-1922	19x22mm	6/36
F0003-1113	11x13mm	12/144	F0003-2123	21x23mm	6/36
F0003-1214	12x14mm	12/120	F0003-2224	22x24mm	6/36
F0003-1315	13x15mm	12/120	F0003-2326	23x26mm	6/60
F0003-1417	14x17mm	12/120	F0003-2427	24x27mm	6/60
F0003-1618	16x18mm	12/120	F0003-3032	30x32mm	6/60

### Double box-end wrench | F0004



ITEM NO.	SIZE	BOX(CTN/PCS)	ITEM NO.	SIZE	BOX(CTN/PCS)
F0004-0607	6x7mm	12/144	F0004-1719	17x19mm	10/100
F0004-0810	8x10mm	12/144	F0004-1921	19x21mm	10/60
F0004-1012	10x12mm	12/144	F0004-1922	19x22mm	10/60
F0004-1113	11x13mm	12/144	F0004-2123	21x23mm	10/60
F0004-1214	12x14mm	12/120	F0004-2224	22x24mm	10/60
F0004-1315	13x15mm	10/100	F0004-2326	23x26mm	10/40
F0004-1417	14x17mm	10/100	F0004-2427	24x27mm	10/40
F0004-1618	16x18mm	10/100	F0004-3032	30x32mm	10/40

### Combination wrench | F0005



ITEM NO.	SIZE	BOX(CTN/PCS)	ITEM NO.	SIZE	BOX(CTN/PCS)	ITEM NO.	SIZE	BOX(CTN/PCS)
F0005-5.5	5.5mm	12/144	F0005-16	16mm	10/100	F0005-27	27mm	6/36
F0005-06	6mm	12/144	F0005-17	17mm	6/72	F0005-28	28mm	6/36
F0005-07	7mm	12/144	F0005-18	18mm	6/36	F0005-29	29mm	6/36
F0005-08	8mm	12/144	F0005-19	19mm	6/36	F0005-30	30mm	2/40
F0005-09	9mm	12/144	F0005-20	20mm	4/24	F0005-31	31mm	2/40
F0005-10	10mm	12/144	F0005-21	21mm	4/24	F0005-32	32mm	2/40
F0005-11	11mm	12/144	F0005-22	22mm	4/24	F0005-34	34mm	5/20
F0005-12	12mm	12/144	F0005-23	23mm	6/36	F0005-36	36mm	5/20
F0005-13	13mm	12/144	F0005-24	24mm	6/36	F0005-38	38mm	5/20
F0005-14	14mm	12/144	F0005-25	25mm	6/36	F0005-41	41mm	5/10
F0005-15	15mm	10/100	F0005-26	26mm	6/36	F0005-46	46mm	5/10
						F0005-50	50mm	5/10

### Adjustable wrench | F0001 F0002 F0102



For nuts



2-in-1 rubber grip

For pipes



High carbon steel drop forged, polished and chrome plated

ITEM NO.	SIZE	BOX(CTN/PCS)
F0001-04	100mm/4"	12/-
F0001-06	150mm/6"	6/72
F0001-08	200mm/8"	6/60
F0001-10	250mm/10"	6/48
F0001-12	300mm/12"	6/24
F0001-15	375mm/15"	1/12
F0001-18	450mm/18"	1/12
F0001-24	600mm/24"	1/6

High carbon steel drop forged with metric marking, phosphated finish

ITEM NO.	SIZE	BOX(CTN/PCS)
F0002-06	150mm/6"	6/72
F0002-08	200mm/8"	6/60
F0002-10	250mm/10"	6/48
F0002-12	300mm/12"	6/24

High carbon steel drop forged, polished and chrome plated

ITEM NO.	SIZE	BOX(CTN/PCS)
F0102-06	150mm/6"	6/72
F0102-08	200mm/8"	6/60
F0102-10	250mm/10"	6/48
F0102-12	300mm/12"	6/24

### Double open-end wrench | F0301

High carbon steel drop forged, mirror polished and chrome plated.



ITEM NO.	SIZE	BOX(CTN/PCS)	ITEM NO.	SIZE	BOX(CTN/PCS)
F0301-5.507	5.5x7mm	24/288	F0301-1618	16x18mm	12/168
F0301-0607	6x7mm	24/288	F0301-1719	17x19mm	12/168
F0301-0608	6x8mm	24/288	F0301-1819	18x19mm	12/168
F0301-0809	8x9mm	24/288	F0301-1821	18x21mm	6/120
F0301-0810	8x10mm	24/288	F0301-1921	19x21mm	6/120
F0301-0911	9x11mm	24/240	F0301-1922	19x22mm	6/120
F0301-1011	10x11mm	24/240	F0301-2022	20x22mm	6/120
F0301-1012	10x12mm	24/240	F0301-2123	21x23mm	6/72
F0301-1113	11x13mm	24/240	F0301-2224	22x24mm	6/72
F0301-1213	12x13mm	24/240	F0301-2326	23x26mm	6/48
F0301-1214	12x14mm	24/240	F0301-2427	24x27mm	6/48
F0301-1315	13x15mm	12/168	F0301-2528	25x28mm	6/48
F0301-1316	13x16mm	12/168	F0301-2629	26x29mm	6/48
F0301-1415	14x15mm	12/168	F0301-2730	27x30mm	6/48
F0301-1417	14x17mm	12/168	F0301-3032	30x32mm	6/48
F0301-1617	16x17mm	12/168			

### Double box-end wrench | F0401

High carbon steel drop forged, mirror polished and chrome plated.



ITEM NO.	SIZE	BOX(CTN/PCS)	ITEM NO.	SIZE	BOX(CTN/PCS)
F0401-5.507	5.5x7mm	24/288	F0401-1618	16x18mm	12/120
F0401-0607	6x7mm	24/288	F0401-1719	17x19mm	12/120
F0401-0608	6x8mm	24/288	F0401-1819	18x19mm	12/120
F0401-0809	8x9mm	24/288	F0401-1821	18x21mm	6/96
F0401-0810	8x10mm	24/288	F0401-1921	19x21mm	6/96
F0401-0911	9x11mm	24/240	F0401-1922	19x22mm	6/96
F0401-1011	10x11mm	24/240	F0401-2022	20x22mm	6/96
F0401-1012	10x12mm	24/240	F0401-2123	21x23mm	6/60
F0401-1113	11x13mm	24/240	F0401-2224	22x24mm	6/60
F0401-1213	12x13mm	24/240	F0401-2326	23x26mm	6/36
F0401-1214	12x14mm	24/240	F0401-2427	24x27mm	6/36
F0401-1315	13x15mm	12/168	F0401-2528	25x28mm	6/36
F0401-1316	13x16mm	12/168	F0401-2629	26x29mm	6/36
F0401-1415	14x15mm	12/168	F0401-2730	27x30mm	6/36
F0401-1417	14x17mm	12/168	F0401-3032	30x32mm	6/36
F0401-1617	16x17mm	12/120			

### Combination wrench | F0501

High carbon steel drop forged, mirror polished and chrome plated.



ITEM NO.	SIZE	BOX(CTN/PCS)	ITEM NO.	SIZE	BOX(CTN/PCS)	ITEM NO.	SIZE	BOX(CTN/PCS)
F0501-5.5	5.5mm	24/288	F0501-19	19mm	12/120	F0501-1/4	1/4"	12/360
F0501-06	6mm	24/288	F0501-20	20mm	12/120	F0501-5/16	5/16"	12/360
F0501-07	7mm	24/288	F0501-21	21mm	6/96	F0501-3/8	3/8"	12/360
F0501-08	8mm	24/288	F0501-22	22mm	6/96	F0501-7/16	7/16"	12/300
F0501-09	9mm	24/288	F0501-23	23mm	6/60	F0501-1/2	1/2"	12/240
F0501-10	10mm	24/288	F0501-24	24mm	6/60	F0501-9/16	9/16"	12/240
F0501-11	11mm	24/288	F0501-25	25mm	6/60	F0501-5/8	5/8"	12/180
F0501-12	12mm	12/240	F0501-26	26mm	6/60	F0501-11/16	11/16"	12/120
F0501-13	13mm	12/240	F0501-27	27mm	6/36	F0501-3/4	3/4"	12/120
F0501-14	14mm	12/240	F0501-28	28mm	6/36	F0501-13/16	13/16"	6/90
F0501-15	15mm	12/168	F0501-29	29mm	6/36	F0501-7/8	7/8"	6/90
F0501-16	16mm	12/168	F0501-30	30mm	6/36	F0501-15/16	15/16"	6/90
F0501-17	17mm	12/168	F0501-31	31mm	6/36			
F0501-18	18mm	12/120	F0501-32	32mm	6/36			



**Combination wrench**

**F0051**

**CR-V**

Chrome vanadium steel drop forged, mirror polished finish



Ratchet box

ITEM NO.	SIZE	BOX(CTN/PCS)	ITEM NO.	SIZE	BOX(CTN/PCS)	ITEM NO.	SIZE	BOX(CTN/PCS)
F0051-06	6mm	10/150	F0051-14	14mm	10/150	F0051-22	22mm	10/60
F0051-07	7mm	10/150	F0051-15	15mm	10/150	F0051-23	23mm	10/60
F0051-08	8mm	10/150	F0051-16	16mm	10/60	F0051-24	24mm	8/48
F0051-09	9mm	10/150	F0051-17	17mm	10/60	F0051-25	25mm	-
F0051-10	10mm	10/150	F0051-18	18mm	10/60	F0051-26	26mm	-
F0051-11	11mm	10/150	F0051-19	19mm	10/60	F0051-27	27mm	-
F0051-12	12mm	10/150	F0051-20	20mm	10/60	F0051-30	30mm	-
F0051-13	13mm	10/150	F0051-21	21mm	10/60	F0051-32	32mm	-

**Ratchet wrench double box end**

**F0106**

CR-V.

Double gear box end



ITEM NO.	SIZE	BOX(CTN/PCS)
F0106-0809	8x9mm	12/144
F0106-0810	8x10mm	12/144
F0106-1011	10x11mm	12/144
F0106-1012	10x12mm	12/144
F0106-1213	12x13mm	12/144
F0106-1214	12x14mm	12/144
F0106-1415	14x15mm	12/108
F0106-1417	14x17mm	12/108
F0106-1618	16x18mm	12/72
F0106-1719	17x19mm	12/72

**Impact spanner open end**

**F0055**

High carbon steel drop forged, phosphated finish.



ITEM NO.	SIZE	BOX(CTN/PCS)
F0055-30	30mm	1/25
F0055-32	32mm	1/25
F0055-34	34mm	1/20
F0055-36	36mm	1/20
F0055-41	41mm	1/20
F0055-46	46mm	1/20
F0055-50	50mm	1/10
F0055-55	55mm	1/10
F0055-60	60mm	1/5
F0055-65	65mm	1/5
F0055-70	70mm	1/5
F0055-75	75mm	1/5

**Impact spanner box end**

**F0056**

High carbon steel drop forged, phosphated finish.



ITEM NO.	SIZE	BOX(CTN/PCS)
F0056-30	30mm	1/25
F0056-32	32mm	1/25
F0056-34	34mm	1/20
F0056-36	36mm	1/20
F0056-41	41mm	1/20
F0056-46	46mm	1/20
F0056-50	50mm	1/10
F0056-55	55mm	1/10
F0056-60	60mm	1/5
F0056-65	65mm	1/5
F0056-70	70mm	1/5
F0056-75	75mm	1/5

**Double open-end wrench set**

High carbon steel drop forged, mirror polished and chrome plated.

**T0003**

**T0003A**

**T0003B**

**T0003C**

8-PC SET

10-PC SET

10-PC SET

6-PC SET



6x7mm 8x9mm 10x11mm  
12x13mm 14x15mm 16x17mm  
18x19mm 20x22mm



6x7mm 8x10mm 10x12mm  
12x14mm 14x17mm 17x19mm  
19x21mm 22x24mm 24x27mm  
30x32mm



6x7mm 8x9mm 10x11mm  
12x13mm 14x15mm 16x17mm  
18x19mm 20x22mm 22x24mm  
24x27mm



8x10mm 10x12mm 12x14mm  
14x17mm 17x19mm 19x22mm

ITEM NO.	SIZE	BOX(CTN/PCS)	ITEM NO.	SIZE	BOX(CTN/PCS)	ITEM NO.	SIZE	BOX(CTN/PCS)	ITEM NO.	SIZE	BOX(CTN/PCS)
T0003	8-pc set	-/12	T0003A	10-pc set	-/12	T0003B	10-pc set	-/12	T0003C	6-pc set	-/12

**Double box-end wrench set**

High carbon steel drop forged, mirror polished and chrome plated.

**T0004**

**T0004A**

**T0004B**

**T0004C**

8-PC SET

10-PC SET

10-PC SET

6-PC SET



6x7mm 8x9mm 10x11mm  
12x13mm 14x15mm 16x17mm  
18x19mm 20x22mm



6x7mm 8x10mm 10x12mm  
12x14mm 14x17mm 17x19mm  
19x22mm 22x24mm 24x27mm  
30x32mm



6x7mm 8x9mm 10x11mm  
12x13mm 14x15mm 16x17mm  
18x19mm 20x22mm 22x24mm  
24x27mm



8x10mm 10x12mm 12x14mm  
14x17mm 17x19mm 19x22mm

ITEM NO.	SIZE	BOX(CTN/PCS)	ITEM NO.	SIZE	BOX(CTN/PCS)	ITEM NO.	SIZE	BOX(CTN/PCS)	ITEM NO.	SIZE	BOX(CTN/PCS)
T0004	8-pc set	-/12	T0004A	10-pc set	-/12	T0004B	10-pc set	-/12	T0004C	6-pc set	-/12

**Combination wrench set**

High carbon steel drop forged, mirror polished and chrome plated.

**T0005**

**T0006**

**T0007**

**T0008**

14-PC SET

14-PC SET

11-PC SET

9-PC SET



8mm 10mm 11mm 12mm 13mm 14mm  
15mm 16mm 17mm 18mm 19mm 21mm  
22mm 24mm



8mm 10mm 11mm 12mm 13mm 14mm  
15mm 17mm 19mm 22mm 24mm 27mm  
30mm 32mm



8mm 9mm 10mm 11mm 12mm 13mm  
14mm 15mm 17mm 19mm 22mm



7mm 8mm 10mm 11mm 12mm 13mm  
14mm 15mm 17mm

ITEM NO.	SIZE	BOX(CTN/PCS)	ITEM NO.	SIZE	BOX(CTN/PCS)	ITEM NO.	SIZE	BOX(CTN/PCS)	ITEM NO.	SIZE	BOX(CTN/PCS)
T0005	14-pc set	-/12	T0006	14-pc set	-/12	T0007	11-pc set	-/12	T0008	9-pc set	-/12

**Self clamping pliers**

**F0050**



9-14mm  
15-22mm  
23-32mm

ITEM NO.	SIZE	BOX(CTN/PCS)
F0050	9-32mm	6/36

**Ratchet wrench with sockets**

Sizes: 8mm 10mm 12mm 13mm 14mm 17mm 19mm

**T0011-A**  
**T0011-B**  
**T0011-C**

CR-V.



FIXED HEAD



FLEXIBLE HEAD



REVERSIBLE

ITEM NO.	SIZE	BOX(CTN/PCS)	ITEM NO.	SIZE	BOX(CTN/PCS)	ITEM NO.	SIZE	BOX(CTN/PCS)	ITEM NO.	SIZE	BOX(CTN/PCS)
T0011-A	6-pc set	12/48	T0011-B	6-pc set	12/48	T0011-C	6-pc set	12/48			



**7-pc ratchet combination wrench set**

**T0009  
T0010**

High carbon steel drop forged, mirror polished and chrome plated.



8mm 10mm 12mm 13mm 14mm 17mm 19mm

ITEM NO.	SIZE	BOX(CTN/PCS)
T0009	7-pc set	-/12



8mm 10mm 12mm 13mm 14mm 17mm 19mm

ITEM NO.	SIZE	BOX(CTN/PCS)
T0010	7-pc set	-/12

**Cross rim wrench  
rubber grip | F0010B**

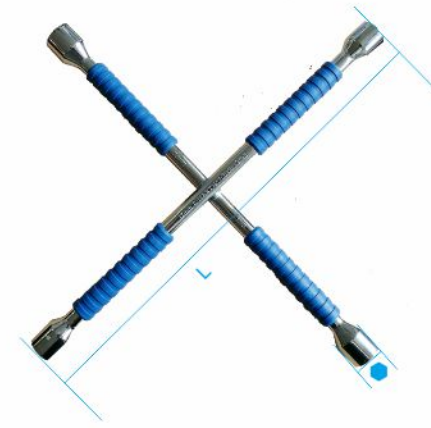

ITEM NO.	SIZE	BOX(CTN/PCS)
F0010B-400	400mm/16"	17x19x21x23mm 4/12
F0010B-500	500mm/20"	17x19x21x23mm 4/12

**Belt wrench | F0007-09**



Chrome vanadium steel drop forged

ITEM NO.	SIZE	BOX(CTN/PCS)
F0007-09	225mm/9"	6/48

**Chain pipe wrench  
F0008-09 | CR-V.**



Chrome vanadium steel drop forged

ITEM NO.	SIZE	BOX(CTN/PCS)
F0008-09	225mm/9"	6/48

**Quick-action cross  
tire wrench | F0010-KS**



ITEM NO.	SIZE	BOX(CTN/PCS)
F0010-KS	17x19x21x23mm	1/12

**10-pc  
T type hex wrench set**

**F0011**



2.0mm 2.5mm  
3.0mm 4.0mm  
4.5mm 5.0mm  
5.5mm 6.0mm  
8.0mm 10.0mm

T-type plastic handle for better grip, chrome vanadium hex black finished

ITEM NO.	SIZE	BOX(CTN/PCS)
F0011	10-pc set	-/12

**1/4" dr. socket driver  
F0121**



ITEM NO.	SIZE	BOX(CTN/PCS)
F0121	6.3mm/1/4"	12/-

**Nut driver  
F0093**



ITEM NO.	SIZE	BOX(CTN/PCS)
F0093-05	5mm	12/120
F0093-5.5	5.5mm	12/120
F0093-06	6mm	12/120
F0093-07	7mm	12/120
F0093-08	8mm	12/120
F0093-10	10mm	12/120

**T-type socket wrench**

**F0091 F0094**

Sockets made of chrome vanadium steel



ITEM NO.	SIZE	L	BOX(CTN/PCS)
F0091-08	8mm	305mm	10/60
F0091-09	9mm	305mm	10/60
F0091-10	10mm	305mm	10/60
F0091-11	11mm	305mm	10/60
F0091-12	12mm	305mm	10/60
F0091-13	13mm	305mm	10/60
F0091-14	14mm	305mm	10/60
F0091-15	15mm	305mm	10/60
F0091-16	16mm	305mm	10/60
F0091-17	17mm	305mm	10/60
F0091-18	18mm	305mm	12/48
F0091-19	19mm	305mm	12/48
F0091-22	22mm	305mm	12/48
F0091-24	24mm	305mm	-



ITEM NO.	SIZE	L	BOX(CTN/PCS)
F0094-08	8mm	305mm	-/50
F0094-09	9mm	305mm	-/50
F0094-10	10mm	305mm	-/50
F0094-11	11mm	305mm	-/50
F0094-12	12mm	305mm	-/50
F0094-13	13mm	305mm	-/50
F0094-14	14mm	305mm	-/50
F0094-15	15mm	305mm	-/50
F0094-16	16mm	305mm	-/50
F0094-17	17mm	305mm	-/50
F0094-18	18mm	305mm	-/50
F0094-19	19mm	305mm	-/50

**L-handle wrench | F0013 F0014 F0141**

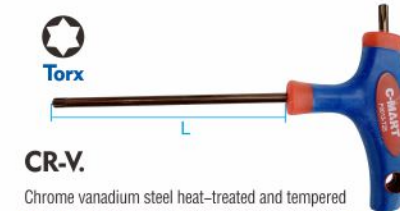

**CR-V.**  
Chrome vanadium steel heat-treated and tempered

ITEM NO.	SIZE	L	BOX(CTN/PCS)
F0013-T09	T9	100mm	12/120
F0013-T10	T10	100mm	12/120
F0013-T15	T15	100mm	12/120
F0013-T20	T20	100mm	12/120
F0013-T25	T25	100mm	12/120
F0013-T27	T27	150mm	12/120
F0013-T30	T30	150mm	12/120
F0013-T40	T40	150mm	12/120
F0013-T45	T45	150mm	12/120
F0013-T50	T50	150mm	12/120

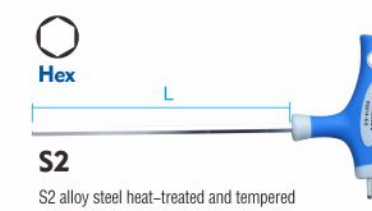

**S2**  
S2 alloy steel heat-treated and tempered

ITEM NO.	SIZE	L	BOX(CTN/PCS)
F0014-2.0	2.0mm	80mm	12/288
F0014-2.5	2.5mm	80mm	12/288
F0014-3.0	3.0mm	100mm	12/288
F0014-4.0	4.0mm	100mm	12/288
F0014-5.0	5.0mm	150mm	12/288
F0014-6.0	6.0mm	150mm	12/192
F0014-8.0	8.0mm	180mm	12/144
F0014-10.0	10.0mm	180mm	12/120

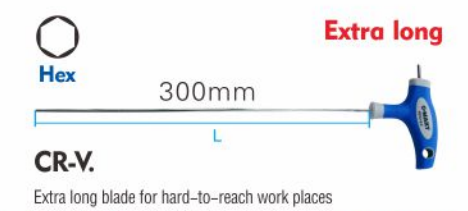

**CR-V.**  
Extra long blade for hard-to-reach work places

ITEM NO.	SIZE	L	BOX(CTN/PCS)
F0141-03	3mm	300mm	-/12
F0141-04	4mm	300mm	-/12
F0141-05	5mm	300mm	-/12
F0141-06	6mm	300mm	-/12
F0141-08	8mm	250mm	-/12
F0141-10	10mm	250mm	-/12

**9-pc hex key set**

**F0191 F0192 F0193**

**CR-V. | Hex**



1.5mm 2.0mm 2.5mm 3.0mm 4.0mm  
5.0mm 6.0mm 8.0mm 10.0mm

ITEM NO.	SIZE	BOX(CTN/PCS)
F0191-MM	9-pc set	6/48



Extra long

1.5mm 2.0mm 2.5mm 3.0mm 4.0mm  
5.0mm 6.0mm 8.0mm 10.0mm

ITEM NO.	SIZE	BOX(CTN/PCS)
F0192-MM	9-pc set	6/48



Extra long arm

1.5mm 2.0mm 2.5mm 3.0mm 4.0mm  
5.0mm 6.0mm 8.0mm 10.0mm

ITEM NO.	SIZE	BOX(CTN/PCS)
F0193-MM	9-pc set	6/48



### 9-pc ball point hex key set

F0015 F0016 F0020 F0021 F0242 F0243



Chrome vanadium steel mirror finish **CR-V.**

ITEM NO.	SIZE	BOX(CTN/PCS)
F0015-MM	1.5 2.0 2.5 3.0 4.0 5.0 6.0 8.0 10.0mm	6/48
F0015-INCH	1/16" 5/64" 3/32" 1/8" 5/32" 3/16" 1/4" 5/16" 3/8"	6/48
F0016-MM	1.5 2.0 2.5 3.0 4.0 5.0 6.0 8.0 10.0mm	6/48
F0016-INCH	1/16" 5/64" 3/32" 1/8" 5/32" 3/16" 1/4" 5/16" 3/8"	6/48

Chrome vanadium steel mirror finish **CR-V.**

ITEM NO.	SIZE	BOX(CTN/PCS)
F0020-MM	1.5 2.0 2.5 3.0 4.0 5.0 6.0 8.0 10.0mm	6/48
F0021-MM	1.5 2.0 2.5 3.0 4.0 5.0 6.0 8.0 10.0mm	6/48

Alloy steel heat treated and red chrome plated **S2**

ITEM NO.	SIZE	BOX(CTN/PCS)
F0242-MM	1.5 2.0 2.5 3.0 4.0 5.0 6.0 8.0 10.0mm	6/48
F0243-MM	1.5 2.0 2.5 3.0 4.0 5.0 6.0 8.0 10.0mm	6/48

### 8-pc ball point hex key set

F0151

Chrome vanadium steel mirror finish



1.5mm 2.0mm 2.5mm 3.0mm 4.0mm  
5.0mm 6.0mm 8.0mm 10.0mm

ITEM NO.	SIZE	BOX(CTN/PCS)
F0151-MM	8-pc set	6/48

### 7-pc torx key set

F0022 | CR-V.



T9 T10 T15 T20 T25 T27 T30

ITEM NO.	SIZE	BOX(CTN/PCS)
F0022-MM	7-pc set	10/60

### 9-pc torx key set

F0023 | CR-V.



T10 T15 T20 T25 T27 T30 T40 T45 T50

ITEM NO.	SIZE	BOX(CTN/PCS)
F0023	9-pc set	10/60

### 9-pc hex key set extra long arm

F0019



Chrome vanadium steel mirror finish

**CR-V.**

ITEM NO.	SIZE	BOX(CTN/PCS)
F0019-MM	1.5 2.0 2.5 3.0 4.0 5.0 6.0 8.0 10.0mm	6/48
F0019-INCH	1/16" 5/64" 3/32" 1/8" 5/32" 3/16" 1/4" 5/16" 3/8"	6/48

### 9-pc torx key set extra long arm

F0231



Chrome vanadium steel mirror finish

ITEM NO.	SIZE	BOX(CTN/PCS)
F0231-MM	1.5 2.0 2.5 3.0 4.0 5.0 6.0 8.0 10.0mm	6/48

### Ball point hex key

F0017 F0171



**S2**

Extra long arm

Alloy steel heat treated and chrome plated



ITEM NO.	SIZE	BOX(CTN/PCS)	ITEM NO.	SIZE	BOX(CTN/PCS)	ITEM NO.	SIZE	BOX(CTN/PCS)
F0017-1.5	1.5mm	10/120	F0017-14.0	14.0mm	1/-	F0017-3/32"	3/32"	10/120
F0017-2.0	2.0mm	10/120	F0017-16.0	16.0mm	1/-	F0017-7/64"	7/64"	10/120
F0017-2.5	2.5mm	10/120	F0017-17.0	17.0mm	1/-	F0017-1/8"	1/8"	10/120
F0017-3.0	3.0mm	10/120	F0017-18.0	18.0mm	1/-	F0017-5/32"	5/32"	10/120
F0017-4.0	4.0mm	10/120	F0017-19.0	19.0mm	1/-	F0017-3/16"	3/16"	6/36
F0017-5.0	5.0mm	6/36	F0017-22.0	22.0mm	1/-	F0017-7/32"	7/32"	6/36
F0017-6.0	6.0mm	6/36	F0017-24.0	24.0mm	1/-	F0017-1/4"	1/4"	2/24
F0017-8.0	8.0mm	2/24	F0017-27.0	27.0mm	1/-	F0017-5/16"	5/16"	2/24
F0017-10.0	10.0mm	1/12	F0017-1/16"	1/16"	10/120	F0017-3/8"	3/8"	1/12
F0017-12.0	12.0mm	1/-	F0017-5/64"	5/64"	10/120			

**CR-V.**

Long arm

Chrome vanadium steel heat treated and tempered, chrome plated

Both ends flat for sizes above 22mm



ITEM NO.	SIZE	BOX(CTN/PCS)	ITEM NO.	SIZE	BOX(CTN/PCS)	ITEM NO.	SIZE	BOX(CTN/PCS)
F0171-1.5	1.5mm	20/200/2000	F0171-10.0	3/12/96	1/-	F0171-22	22.0mm	1/-
F0171-2.0	2.0mm	20/200/2000	F0171-12.0	1/-	1/-	F0171-24	24.0mm	1/-
F0171-2.5	2.5mm	20/200/2000	F0171-13.0	1/-	1/-	F0171-27	27.0mm	1/-
F0171-3.0	3.0mm	12/144/1440	F0171-14.0	1/-	1/-	F0171-29	29.0mm	1/-
F0171-4.0	4.0mm	12/72/720	F0171-15.0	1/-	1/-	F0171-30	30.0mm	1/-
F0171-5.0	5.0mm	6/36/360	F0171-16.0	1/-	1/-	F0171-32	32.0mm	1/-
F0171-6.0	6.0mm	6/30/300	F0171-17.0	1/-	1/-	F0171-34	34.0mm	1/-
F0171-8.0	8.0mm	6/24/196	F0171-19.0	1/-	1/-	F0171-36	36.0mm	1/-

### Reversible ratchet handle

F0028 F0027 F0281 F0271 F0283 F0282 F0284

life time free repair parts



**45T**

Ratchet made of chrome molybdenum steel

ITEM NO.	SIZE	BOX(CTN/PCS)
F0028-1/2	1/2"DR. 12.5mm	6/24

life time free repair parts



**48T**

Ratchet made of chrome molybdenum steel

ITEM NO.	SIZE	BOX(CTN/PCS)
F0281-1/2	1/2"DR. 12.5mm	6/36
F0281-3/8	3/8"DR. 10.0mm	6/48
F0281-1/4	1/4"DR. 6.3mm	6/48

life time free repair parts



**72T**

Ratchet made of chrome molybdenum steel

ITEM NO.	SIZE	BOX(CTN/PCS)
F0283-1/2	1/2"DR. 12.5mm	6/30
F0283-1/4	1/4"DR. 6.3mm	6/36



F0027 / F0271



F0027A

Ratchet made of chrome molybdenum steel

ITEM NO.	SIZE	L	BOX(CTN/PCS)
F0027	3/4"DR.	510mm/20"	6/36
F0271	1"DR.	760mm/32"	6/36
F0027A	Ratchet head	3/4"DR.	6/36
F0271A	Ratchet head	1"DR.	6/36



Ratchet made of chrome molybdenum steel

ITEM NO.	SIZE	BOX(CTN/PCS)
F0282	1/2"DR. 12.5mm	6/36



**72T**

Ratchet made of chrome molybdenum steel

ITEM NO.	SIZE	BOX(CTN/PCS)
F0284-1/2	1/2"DR. 300/440mm	6/24



**Socket wrench flexible handle** | F0026

Chrome vanadium steel mirror finish



ITEM NO.	SIZE	L	BOX(CTN/PCS)
F0026-1/2	1/2"DR.	425mm/17"	6/24
F0026-3/4	3/4"DR.	500mm/20"	6/12

**Torque wrench** | F0025



ITEM NO.	SIZE	BOX(CTN/PCS)
F0025-20	20kgs-210N.M	1/10
F0025-30	30kgs-350N.M	1/8

**Dial torque wrench**  
F0252



ITEM NO.	SIZE	BOX(CTN/PCS)
F0252	0-300Nm	1/20

**Sliding T handle**

F0034 F0341 F0342 F0343 F0344

Chrome vanadium steel mirror finish

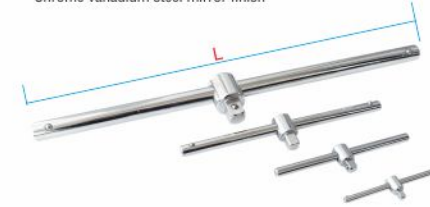

ITEM NO.	SIZE	L	BOX(CTN/PCS)
F0034-10	1/2"DR.	250mm/10"	6/54
F0341-06	3/8"DR.	160mm/6"	12/-
F0342-4.5	1/4"DR.	115mm/4.5"	12/-
F0343-20	3/4"DR.	500mm/20"	12/-
F0344-20	1"DR.	500mm/20"	12/-

**Extension bar** | F0035 F0351 F0352 F0353 F0354

Chrome vanadium steel mirror finish



ITEM NO.	SIZE	L	BOX(CTN/PCS)	ITEM NO.	SIZE	L	BOX(CTN/PCS)
F0035-05	1/2"DR.	125mm/5"	6/96	F0352-02	1/4"DR.	50mm/2"	-
F0035-10	1/2"DR.	250mm/10"	6/54	F0352-04	1/4"DR.	100mm/4"	-
F0351-03	3/8"DR.	75mm/3"	-	F0353-08	3/4"DR.	200mm/8"	-
F0351-06	3/8"DR.	150mm/6"	-	F0354-08	1"DR.	200mm/8"	-
F0351-10	3/8"DR.	250mm/10"	-	F0354-16	1"DR.	400mm/16"	-

**Double socket ratchet wrench** | F0030

Socket made of chrome molybdenum steel, black phosphated finish



ITEM NO.	SIZE	BOX(CTN/PCS)	ITEM NO.	SIZE	BOX(CTN/PCS)	ITEM NO.	SIZE	BOX(CTN/PCS)
F0030-1012	10x12mm	2/50	F0030-1721	17x21mm	2/40	F0030-2224	22x24mm	2/32
F0030-1113	11x13mm	2/50	F0030-1719	17x19mm	2/40	F0030-2326	23x26mm	2/32
F0030-1214	12x14mm	2/50	F0030-1921	19x21mm	2/40	F0030-2427	24x27mm	2/32
F0030-1315	13x15mm	2/40	F0030-1922	19x22mm	2/40	F0030-3032	30x32mm	2/32
F0030-1317	13x17mm	2/40	F0030-1924	19x24mm	-	F0030-3236	32x36mm	-
F0030-1417	14x17mm	2/40	F0030-2123	21x23mm	2/32	F0030-3641	36x41mm	-
F0030-1618	16x18mm	2/40	F0030-2126	21x26mm	2/32	F0030-4146	41x46mm	-

**Universal joint** | F0036 F0361 F0362

Chrome vanadium steel mirror finish



ITEM NO.	SIZE	BOX(CTN/PCS)
F0036	1/2"DR.	12/120
F0361	3/8"DR.	12/120
F0362	1/4"DR.	12/120

**Adapter** | F0037 F0038 F0381

Chrome vanadium steel mirror finish

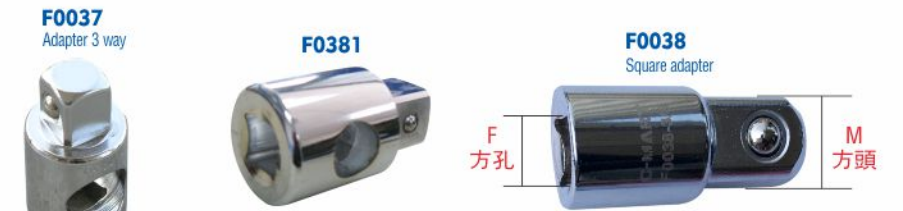

ITEM NO.	FDR	MDR	SIZE	BOX(CTN/PCS)	ITEM NO.	FDR	MDR	SIZE	BOX(CTN/PCS)
F0037-1/2-3/8	F1/2	M3/8	12.5mm	12/-	F0038-1/2-3/8	F1/2	M3/8	12.5mm	12/-
F0037-3/8-1/2	F3/8	M1/2	10.0mm	12/-	F0038-3/8-1/2	F3/8	M1/2	10.0mm	12/-
ITEM NO.	SIZE	BOX(CTN/PCS)	ITEM NO.	FDR	MDR	SIZE	BOX(CTN/PCS)		
F0381-3/4	3/4"DR. 1"DR.	12/-	F0038-3/8-1/4	F3/8	M1/4	10.0mm	12/-		
			F0038-1/4-3/8	F1/4	M3/8	6.30mm	12/-		

**L type handle**  
F0032 F0321 F0322 F0323

Chrome vanadium steel mirror finish

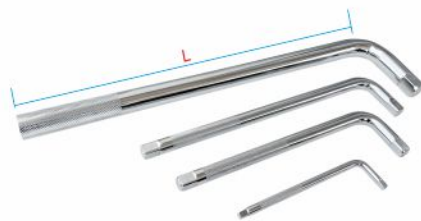

ITEM NO.	SIZE	L	BOX(CTN/PCS)
F0032-10	1/2"DR.	250mm/10"	10/60
F0032-12	1/2"DR.	300mm/12"	10/40
F0321-18	3/4"DR.	450mm/18"	10/-
F0322-17	1"DR.	427mm/17"	12/-
F0323-06	1/4"DR.	150mm/6"	-

**L type tire socket wrench**  
F0133

Chrome vanadium steel mirror finish



ITEM NO.	SIZE	BOX(CTN/PCS)
F0133-17	17mm	6/48
F0133-19	19mm	6/48
F0133-21	21mm	6/48
F0133-22	22mm	6/48
F0133-23	23mm	6/48
F0133-24	24mm	6/48

**Tire socket wrench telescopic handle**

Chrome vanadium steel mirror finish | F0033



ITEM NO.	SIZE	BOX(CTN/PCS)
F0033-1/2	340/545mm	6/24

**Bit sockets** | F0039-PH F0040-PH F0041-PH-100 | F0039-PZ F0040-PZ F0041-M-100



ITEM NO.	SIZE	SIZE	BOX(CTN/PCS)
F0039-PH1	1/4"DR.	PH1x37mm	24/-
F0039-PH2	1/4"DR.	PH2x37mm	24/-
F0039-PH3	1/4"DR.	PH3x37mm	24/-
F0040-PH1	3/8"DR.	PH1x50mm	12/-
F0040-PH2	3/8"DR.	PH2x50mm	12/-
F0040-PH3	3/8"DR.	PH3x50mm	12/-
F0041-PH2-100	1/2"DR.	PH2x100mm	12/144
F0041-PH3-100	1/2"DR.	PH3x100mm	12/144
F0041-PH4-100	1/2"DR.	PH4x100mm	12/144

ITEM NO.	SIZE	SIZE	BOX(CTN/PCS)
F0041-M05-100	1/2"DR.	M5x100mm	12/144
F0041-M06-100	1/2"DR.	M6x100mm	12/144
F0041-M08-100	1/2"DR.	M8x100mm	12/144
F0041-M10-100	1/2"DR.	M10x100mm	12/144
F0041-M12-100	1/2"DR.	M12x100mm	12/144
F0041-M14-100	1/2"DR.	M14x100mm	12/144
F0041-M16-100	1/2"DR.	M16x100mm	12/144
F0041-M18-100	1/2"DR.	M18x100mm	12/144

ITEM NO.	SIZE	SIZE	BOX(CTN/PCS)
F0039-PZ1	1/4"DR.	PZ1x37mm	24/-
F0039-PZ2	1/4"DR.	PZ2x37mm	24/-
F0039-PZ3	1/4"DR.	PZ3x37mm	24/-
F0040-PZ1	3/8"DR.	PZ1x50mm	12/-
F0040-PZ2	3/8"DR.	PZ2x50mm	12/-
F0040-PZ3	3/8"DR.	PZ3x50mm	12/-



Bit sockets

F0039-H F0040-H F0041-H-55 F0041-H-100  
 F0039-T F0041-T-55 F0041-T-100  
 F0039-FD F0040-FD F0041-FD F0040-T-Z



ITEM NO.	SIZE	SIZE	BOX(CTN/PCS)	ITEM NO.	SIZE	SIZE	BOX(CTN/PCS)	ITEM NO.	SIZE	SIZE	BOX(CTN/PCS)
F0039-H03	1/4"DR.	H3x37mm	24/-	F0040-H07	3/8"DR.	H7x50mm	12/-	F0041-H17-100	1/2"DR.	H17x100mm	12/144
F0039-H04	1/4"DR.	H4x37mm	24/-	F0040-H08	3/8"DR.	H8x50mm	12/-	F0041-H19-100	1/2"DR.	H19x100mm	8/96
F0039-H05	1/4"DR.	H5x37mm	24/-	F0040-H10	3/8"DR.	H10x50mm	12/-	F0041-H04-55	1/2"DR.	H4x55mm	12/144
F0039-H06	1/4"DR.	H6x37mm	24/-	F0041-H04-100	1/2"DR.	H4x100mm	12/144	F0041-H05-55	1/2"DR.	H5x55mm	12/144
F0039-H07	1/4"DR.	H7x37mm	24/-	F0041-H05-100	1/2"DR.	H5x100mm	12/144	F0041-H06-55	1/2"DR.	H6x55mm	12/144
F0039-H08	1/4"DR.	H8x37mm	24/-	F0041-H06-100	1/2"DR.	H6x100mm	12/144	F0041-H07-55	1/2"DR.	H7x55mm	12/144
F0039-H10	1/4"DR.	H10x37mm	24/-	F0041-H07-100	1/2"DR.	H7x100mm	12/144	F0041-H08-55	1/2"DR.	H8x55mm	12/144
F0040-H03	3/8"DR.	H3x50mm	12/-	F0041-H08-100	1/2"DR.	H8x100mm	12/144	F0041-H10-55	1/2"DR.	H10x55mm	12/144
F0040-H04	3/8"DR.	H4x50mm	12/-	F0041-H10-100	1/2"DR.	H10x100mm	12/144	F0041-H12-55	1/2"DR.	H12x55mm	12/144
F0040-H05	3/8"DR.	H5x50mm	12/-	F0041-H12-100	1/2"DR.	H12x100mm	12/144	F0041-H14-55	1/2"DR.	H14x55mm	12/144
F0040-H06	3/8"DR.	H6x50mm	12/-	F0041-H14-100	1/2"DR.	H14x100mm	12/144	F0041-H06-250	1/2"DR.	H6x250mm	-



ITEM NO.	SIZE	SIZE	BOX(CTN/PCS)	ITEM NO.	SIZE	SIZE	BOX(CTN/PCS)	ITEM NO.	SIZE	SIZE	BOX(CTN/PCS)
F0039-T08	1/4"DR.	T8x37mm	24/-	F0041-T27-100	1/2"DR.	T27x100mm	12/144	F0041-T20-55	1/2"DR.	T20x55mm	12/144
F0039-T10	1/4"DR.	T10x37mm	24/-	F0041-T30-100	1/2"DR.	T30x100mm	12/144	F0041-T25-55	1/2"DR.	T25x55mm	12/144
F0039-T15	1/4"DR.	T15x37mm	24/-	F0041-T35-100	1/2"DR.	T35x100mm	12/144	F0041-T27-55	1/2"DR.	T27x55mm	12/144
F0039-T20	1/4"DR.	T20x37mm	24/-	F0041-T40-100	1/2"DR.	T40x100mm	12/144	F0041-T30-55	1/2"DR.	T30x55mm	12/144
F0039-T25	1/4"DR.	T25x37mm	24/-	F0041-T45-100	1/2"DR.	T45x100mm	12/144	F0041-T40-55	1/2"DR.	T40x55mm	12/144
F0039-T30	1/4"DR.	T30x37mm	24/-	F0041-T50-100	1/2"DR.	T50x100mm	12/144	F0041-T45-55	1/2"DR.	T45x55mm	12/144
F0039-T40	1/4"DR.	T40x37mm	24/-	F0041-T55-100	1/2"DR.	T55x100mm	12/144	F0041-T50-55	1/2"DR.	T50x55mm	12/144
F0041-T20-100	1/2"DR.	T20x100mm	12/144	F0041-T60-100	1/2"DR.	T60x100mm	12/144	F0041-T52-55	1/2"DR.	T52x55mm	12/144
F0041-T25-100	1/2"DR.	T25x100mm	12/144	F0041-T70-100	1/2"DR.	T70x100mm	12/144	F0041-T55-55	1/2"DR.	T55x55mm	12/144



ITEM NO.	SIZE	SIZE	BOX(CTN/PCS)
F0039-FD4	1/4"DR.	FD4x37mm	24/-
F0039-FD5.5	1/4"DR.	FD5.5x37mm	24/-
F0039-FD6.5	1/4"DR.	FD6.5x37mm	24/-
F0040-FD4	3/8"DR.	FD4x50mm	24/-
F0040-FD5.5	3/8"DR.	FD5.5x50mm	24/-
F0040-FD6.5	3/8"DR.	FD6.5x50mm	24/-
F0040-FD8	3/8"DR.	FD8x50mm	24/-
F0041-FD08-100	1/2"DR.	FD8x100mm	12/144
F0041-FD10-100	1/2"DR.	FD10x100mm	12/144
F0041-FD12-100	1/2"DR.	FD12x100mm	12/144

ITEM NO.	SIZE	SIZE	BOX(CTN/PCS)
F0040-T08-Z	3/8"DR.	T8x50mm	-
F0040-T10-Z	3/8"DR.	T10x50mm	-
F0040-T15-Z	3/8"DR.	T15x50mm	-
F0040-T20-Z	3/8"DR.	T20x50mm	-
F0040-T25-Z	3/8"DR.	T25x50mm	-
F0040-T27-Z	3/8"DR.	T27x50mm	-
F0040-T30-Z	3/8"DR.	T30x50mm	-
F0040-T40-Z	3/8"DR.	T40x50mm	-
F0040-T45-Z	3/8"DR.	T45x50mm	-
F0040-T50-Z	3/8"DR.	T50x50mm	-
F0040-T55-Z	3/8"DR.	T55x50mm	-
F0040-T60-Z	3/8"DR.	T60x50mm	-

6pt reg sockets

F0029-6 F0292-6 F0029A-6 F0294-6

F0029-6  
1/2"DR.

Chrome vanadium steel,  
mirror finish



ITEM NO.	SIZE	BOX(CTN/PCS)	ITEM NO.	SIZE	BOX(CTN/PCS)
F0029-6-08	8mm	12/288	F0029-6-21	21mm	12/144
F0029-6-09	9mm	12/288	F0029-6-22	22mm	12/144
F0029-6-10	10mm	12/288	F0029-6-23	23mm	12/144
F0029-6-11	11mm	12/288	F0029-6-24	24mm	12/144
F0029-6-12	12mm	12/288	F0029-6-25	25mm	12/96
F0029-6-13	13mm	12/288	F0029-6-26	26mm	12/96
F0029-6-14	14mm	12/288	F0029-6-27	27mm	12/96
F0029-6-15	15mm	12/288	F0029-6-28	28mm	12/96
F0029-6-16	16mm	12/288	F0029-6-29	29mm	12/96
F0029-6-17	17mm	12/144	F0029-6-30	30mm	12/96
F0029-6-18	18mm	12/144	F0029-6-32	32mm	12/96
F0029-6-19	19mm	12/144	F0029-6-34	34mm	-
F0029-6-20	20mm	12/144	F0029-6-36	36mm	-

F0029A-6  
1/2"DR.

Carbon steel heat treated.  
Chrome plated with blue ribbon



ITEM NO.	SIZE	BOX(CTN/PCS)	ITEM NO.	SIZE	BOX(CTN/PCS)
F0029A-6-08	8mm	12/288	F0029A-6-21	21mm	12/144
F0029A-6-09	9mm	12/288	F0029A-6-22	22mm	12/144
F0029A-6-10	10mm	12/288	F0029A-6-23	23mm	12/144
F0029A-6-11	11mm	12/288	F0029A-6-24	24mm	12/144
F0029A-6-12	12mm	12/288	F0029A-6-25	25mm	12/96
F0029A-6-13	13mm	12/288	F0029A-6-26	26mm	12/96
F0029A-6-14	14mm	12/288	F0029A-6-27	27mm	12/96
F0029A-6-15	15mm	12/288	F0029A-6-28	28mm	12/96
F0029A-6-16	16mm	12/288	F0029A-6-29	29mm	12/96
F0029A-6-17	17mm	12/144	F0029A-6-30	30mm	12/96
F0029A-6-18	18mm	12/144	F0029A-6-32	32mm	12/96
F0029A-6-19	19mm	12/144	F0029A-6-34	34mm	-
F0029A-6-20	20mm	12/144	F0029A-6-36	36mm	-

F0292-6

3/8"DR.

Chrome vanadium steel,  
mirror finish

CR-V.



ITEM NO.	SIZE	BOX(CTN/PCS)	ITEM NO.	SIZE	BOX(CTN/PCS)
F0292-6-06	6mm	12/540	F0292-6-16	16mm	12/288
F0292-6-07	7mm	12/540	F0292-6-17	17mm	12/288
F0292-6-08	8mm	12/540	F0292-6-18	18mm	12/288
F0292-6-09	9mm	12/540	F0292-6-19	19mm	12/288
F0292-6-10	10mm	12/540	F0292-6-20	20mm	12/216
F0292-6-11	11mm	12/540	F0292-6-21	21mm	12/216
F0292-6-12	12mm	12/540	F0292-6-22	22mm	12/216
F0292-6-13	13mm	12/360	F0292-6-23	23mm	12/216
F0292-6-14	14mm	12/360	F0292-6-24	24mm	12/216
F0292-6-15	15mm	12/288			

F0294-6

1/4"DR.

Chrome vanadium steel,  
mirror finish

CR-V.



ITEM NO.	SIZE	BOX(CTN/PCS)	ITEM NO.	SIZE	BOX(CTN/PCS)
F0294-6-04	4mm	24/-	F0294-6-09	9mm	24/-
F0294-6-4.5	4.5mm	24/-	F0294-6-10	10mm	12/-
F0294-6-05	5mm	24/-	F0294-6-11	11mm	12/-
F0294-6-5.5	5.5mm	24/-	F0294-6-12	12mm	12/-
F0294-6-06	6mm	24/-	F0294-6-13	13mm	12/-
F0294-6-07	7mm	24/-	F0294-6-14	14mm	12/-
F0294-6-08	8mm	24/-			

12pt reg sockets

F0029-12 | CR-V.

1/2"DR.

Chrome vanadium steel,  
mirror finish



ITEM NO.	SIZE	BOX(CTN/PCS)	ITEM NO.	SIZE	BOX(CTN/PCS)	ITEM NO.	SIZE	BOX(CTN/PCS)
F0029-12-08	8mm	12/288	F0029-12-17	17mm	12/144	F0029-12-26	26mm	12/96
F0029-12-09	9mm	12/288	F0029-12-18	18mm	12/144	F0029-12-27	27mm	12/96
F0029-12-10	10mm	12/288	F0029-12-19	19mm	12/144	F0029-12-28	28mm	12/96
F0029-12-11	11mm	12/288	F0029-12-20	20mm	12/144	F0029-12-29	29mm	12/96
F0029-12-12	12mm	12/288	F0029-12-21	21mm	12/144	F0029-12-30	30mm	12/96
F0029-12-13	13mm	12/288	F0029-12-22	22mm	12/144	F0029-12-32	32mm	12/96
F0029-12-14	14mm	12/288	F0029-12-23	23mm	12/144	F0029-12-34	34mm	-
F0029-12-15	15mm	12/288	F0029-12-24	24mm	12/144	F0029-12-36	36mm	-
F0029-12-16	16mm	12/288	F0029-12-25	25mm	12/96			



### 12pt reg sockets

F1029-12 F2029-12

Chrome vanadium steel,  
mirror finish

F1029-12  
3/4"DR.  
CR-V.



F2029-12  
1"DR.  
CR-V.



ITEM NO.	SIZE	H	ITEM NO.	SIZE	H
F1029-12-19	19mm	50mm	F1029-12-32	32mm	56mm
F1029-12-21	21mm	50mm	F1029-12-34	34mm	56mm
F1029-12-22	22mm	51mm	F1029-12-36	36mm	58mm
F1029-12-23	23mm	51mm	F1029-12-38	38mm	60mm
F1029-12-24	24mm	51mm	F1029-12-41	41mm	64mm
F1029-12-26	26mm	52mm	F1029-12-46	46mm	68mm
F1029-12-27	27mm	52mm	F1029-12-48	48mm	70mm
F1029-12-28	28mm	54mm	F1029-12-50	50mm	72mm
F1029-12-29	29mm	54mm	F1029-12-55	55mm	76mm
F1029-12-30	30mm	56mm	F1029-12-60	60mm	78mm
F1029-12-31	31mm	56mm	F1029-12-65	65mm	80mm

ITEM NO.	SIZE	H	ITEM NO.	SIZE	H
F2029-12-30	30mm	60mm	F2029-12-48	48mm	70mm
F2029-12-31	31mm	60mm	F2029-12-50	50mm	70mm
F2029-12-32	32mm	60mm	F2029-12-55	55mm	87mm
F2029-12-34	34mm	60mm	F2029-12-60	60mm	91mm
F2029-12-36	36mm	60mm	F2029-12-65	65mm	95mm
F2029-12-38	38mm	60mm	F2029-12-70	70mm	100mm
F2029-12-41	41mm	60mm	F2029-12-75	75mm	105mm
F2029-12-46	46mm	70mm	F2029-12-80	80mm	105mm

### 6pt deep. sockets

F0291-6 F0295-6 F0293-6

CR-V.

F0291-6  
1/2"DR.  
Chrome vanadium steel,  
mirror finish



F0295-6  
1/4"DR.  
Chrome vanadium steel,  
mirror finish



F0293-6  
3/8"DR.  
Chrome vanadium steel,  
mirror finish



ITEM NO.	SIZE	BOX(CTN/PCS)
F0291-6-08	8mm	12/216
F0291-6-09	9mm	12/216
F0291-6-10	10mm	12/216
F0291-6-11	11mm	12/216
F0291-6-12	12mm	12/216
F0291-6-13	13mm	12/216
F0291-6-14	14mm	12/216
F0291-6-15	15mm	12/216
F0291-6-16	16mm	12/216
F0291-6-17	17mm	12/96
F0291-6-18	18mm	12/96
F0291-6-19	19mm	12/96
F0291-6-21	21mm	12/72
F0291-6-22	22mm	12/72
F0291-6-24	24mm	12/72
F0291-6-27	27mm	12/72
F0291-6-30	30mm	12/72
F0291-12-08	8mm	
F0291-12-10	10mm	
F0291-12-12	12mm	
F0291-12-14	14mm	
F0291-12-17	17mm	
F0291-12-19	19mm	

ITEM NO.	SIZE	BOX(CTN/PCS)
F0295-6-04	4mm	24/-
F0295-6-4.5	4.5mm	24/-
F0295-6-05	5mm	24/-
F0295-6-5.5	5.5mm	24/-
F0295-6-06	6mm	24/-
F0295-6-07	7mm	24/-
F0295-6-08	8mm	24/-
F0295-6-09	9mm	24/-
F0295-6-10	10mm	12/-
F0295-6-11	11mm	12/-
F0295-6-12	12mm	12/-
F0295-6-13	13mm	12/-
F0295-6-14	14mm	12/-

ITEM NO.	SIZE	BOX(CTN/PCS)
F0293-6-06	6mm	12/540
F0293-6-07	7mm	12/540
F0293-6-08	8mm	12/540
F0293-6-09	9mm	12/540
F0293-6-10	10mm	12/540
F0293-6-11	11mm	12/540
F0293-6-12	12mm	12/540
F0293-6-13	13mm	12/360
F0293-6-14	14mm	12/360
F0293-6-15	15mm	12/288
F0293-6-16	16mm	12/288
F0293-6-17	17mm	12/288
F0293-6-18	18mm	12/288
F0293-6-19	19mm	12/288
F0293-6-20	20mm	12/216
F0293-6-21	21mm	12/216
F0293-6-22	22mm	12/216
F0293-6-23	23mm	12/216
F0293-6-24	24mm	12/216

### Spark plug socket

F0296 F0297 F0298

CR-V.

F0296

1/2"DR.

Chrome vanadium steel,  
mirror finish



ITEM NO.	SIZE	BOX(CTN/PCS)
F0296-16	16mm	12/216
F0296-21	21mm	12/96

F0297

1/2"DR.

Chrome vanadium steel,  
mirror finish



ITEM NO.	SIZE	BOX(CTN/PCS)
F0297-16	16mm	10/60
F0297-21	21mm	10/60

F0298

1/2"DR.

Chrome vanadium steel,  
mirror finish

Flex spark plug socket



ITEM NO.	SIZE	BOX(CTN/PCS)
F0298-16	16mm	12/216
F0298-21	21mm	10/60

### Impact sockets

F0042 F0046

Made of chrome molybdenum steel,  
black phosphated finish

F0042

1/2"DR.

CR-MO



ITEM NO.	SIZE	BOX(CTN/PCS)	ITEM NO.	SIZE	BOX(CTN/PCS)
F0042-10	10mm	12/-	F0040-19	19mm	12/-
F0042-11	11mm	12/-	F0042-21	21mm	12/-
F0042-12	12mm	12/-	F0042-22	22mm	12/-
F0042-13	13mm	12/-	F0042-23	23mm	12/-
F0043-14	14mm	12/-	F0043-24	24mm	12/-
F0042-15	15mm	12/-	F0042-27	27mm	12/-
F0042-16	16mm	12/-	F0042-29	29mm	12/-
F0042-17	17mm	12/-	F0042-30	30mm	12/-

F0046

3/4"DR.

CR-MO



ITEM NO.	SIZE	BOX(CTN/PCS)	ITEM NO.	SIZE	BOX(CTN/PCS)
F0046-17	17mm	12/-	F0046-31	31mm	12/-
F0046-19	19mm	12/-	F0046-32	32mm	12/-
F0046-20	20mm	12/-	F0046-33	33mm	12/-
F0046-21	21mm	12/-	F0046-34	34mm	12/-
F0046-22	22mm	12/-	F0046-36	36mm	12/-
F0046-23	23mm	12/-	F0046-38	38mm	12/-
F0046-24	24mm	12/-	F0046-41	41mm	12/-
F0046-26	26mm	12/-	F0046-46	46mm	12/-
F0046-27	27mm	12/-	F0046-48	48mm	12/-
F0046-28	28mm	12/-	F0046-50	50mm	12/-
F0046-29	29mm	12/-	F0046-55	55mm	12/-
F0046-30	30mm	12/-			

### Impact deep. sockets

F0421

Made of chrome molybdenum steel, black phosphated finish

F0421

1/2"DR.

CR-MO



ITEM NO.	SIZE	BOX(CTN/PCS)	ITEM NO.	SIZE	BOX(CTN/PCS)
F0421-10	10mm	12/-	F0421-19	19mm	12/-
F0421-11	11mm	12/-	F0421-21	21mm	12/-
F0421-12	12mm	12/-	F0421-22	22mm	12/-
F0421-13	13mm	12/-	F0421-23	23mm	12/-
F0421-14	14mm	12/-	F0421-24	24mm	12/-
F0421-15	15mm	12/-	F0421-26	26mm	12/-
F0421-16	16mm	12/-	F0421-27	27mm	12/-
F0421-17	17mm	12/-	F0421-29	29mm	12/-
F0421-18	18mm	12/-	F0421-30	30mm	12/-
			F0421-32	32mm	12/-

### Impact extension bar

F0045

Made of chrome molybdenum steel, black phosphated finish

F0045

1/2"DR.

CR-MO



ITEM NO.	SIZE	BOX(CTN/PCS)
F0045-03	75mm/3"	12/-
F0045-05	125mm/5"	12/-
F0045-10	250mm/10"	12/-



**Impact sockets | F0047** | Made of chrome molybdenum steel, black phosphated finish

1"DR.  
CR-MO



ITEM NO.	SIZE	BOX(CTN/PCS)	ITEM NO.	SIZE	BOX(CTN/PCS)	ITEM NO.	SIZE	BOX(CTN/PCS)
F0047-17	17mm	1/36	F0047-29	29mm	1/36	F0047-55	55mm	-
F0047-19	19mm	1/36	F0047-30	30mm	1/36	F0047-56	56mm	-
F0047-20	20mm	1/36	F0047-31	31mm	1/36	F0047-58	58mm	-
F0047-21	21mm	1/36	F0047-32	32mm	1/36	F0047-60	60mm	-
F0047-22	22mm	1/36	F0047-34	34mm	1/36	F0047-63	63mm	-
F0047-23	23mm	1/36	F0047-36	36mm	1/36	F0047-65	65mm	-
F0047-24	24mm	1/36	F0047-41	41mm	-	F0047-70	70mm	-
F0047-26	26mm	1/36	F0047-46	46mm	-	F0047-75	75mm	-
F0047-27	27mm	1/36	F0047-48	48mm	-	F0047-80	80mm	-
F0047-28	28mm	1/36	F0047-50	50mm	-			

**Impact bit sockets | F0049**

Made of chrome molybdenum steel, black phosphated finish

1/2"DR.  
CR-MO



ITEM NO.	SIZE	BOX(CTN/PCS)	ITEM NO.	SIZE	BOX(CTN/PCS)
F0049-H04	H4	12/-	F0049-H12	H12	12/-
F0049-H05	H5	12/-	F0049-H14	H14	12/-
F0049-H06	H6	12/-	F0049-H17	H17	12/-
F0049-H08	H8	12/-	F0049-H19	H19	12/-
F0049-H10	H10	12/-			

**Magnetic nut setters | F0043 F0043A**



ITEM NO.	SIZE	ITEM NO.	SIZE
F0043-0842	8mm(5/16")xL42	F0043A-1048	10x48mm
F0043-0865	8mm(5/16")xL65	F0043A-1248	12x48mm
F0043A-0842	8x42mm	F0043A-1348	13x48mm
F0043A-0865	8x65mm	F0043A-1465	14x65mm

**Oil filter wrench S0001-11**



Heavy duty drop-forged slip joint wrench with double dipped comfort grip handle  
Fits 2 1/8"-3 1/2" (63.5-89mm) filters

ITEM NO.	SIZE	BOX(CTN/PCS)
S0001-11	280mm/11"	6/48

**Piston ring compressor S0003**



Self locking ratchet pawl prevents premature release and allows positive locking action

ITEM NO.	SIZE	APPLICABLE DIA.	BOX(CTN/PCS)
S0003-03	3"	53-175mm	1/50
S0003-04	4"	60-175mm	1/50
S0003-06	6"	60-195mm	1/50

**Trim pad remover S0008**



ITEM NO.	SIZE	BOX(CTN/PCS)
S0008-06	150mm/6"	-
S0008-08	200mm/8"	-

**Oil filter wrench | S0002 S0021**



Swivel handle

90 degree swivel to access filters in confined areas.  
Black wide band resists corrosion and prevent the filter from being crushed.  
Optimum transmission of force due to ergonomically designed handgrips.



ITEM NO.	SIZE	BOX(CTN/PCS)
S0002-6073	2-3/8"-2-7/8"	6/48
S0002-7385	2-7/8"-3-3/8"	6/48

ITEM NO.	SIZE	BOX(CTN/PCS)
S0021-5575	55-75mm	6/60
S0021-7595	75/95mm	6/60

**3-prong oil filter wrench | S0004 S0005**



21mm male hexagon  
Fits 2-3/4" to 4-1/2" (70mm-110mm)

ITEM NO.	SIZE	BOX(CTN/PCS)
S0004		1/40



21mm male hexagon  
Fits 2-3/4" to 4-1/2" (70mm-110mm)

ITEM NO.	SIZE	BOX(CTN/PCS)
S0005		1/40

**Inflator and gauge kit | S0015 S0015S**



Aluminum handle with gauge and hose  
3-in-1 function: inflating, deflating and measurement of tire air pressure

ITEM NO.	SIZE	BOX(CTN/PCS)
S0015		10/40



Digital display

Nozzle length: 80mm  
Maximum pressure: ≤0.8Mpa  
Applicable pressure: ≤0.2-0.4Mpa  
For tires, balls, inflatable toys and rubber boats  
Valve core adjustment pin stored in handle

ITEM NO.	SIZE	BOX(CTN/PCS)
S0015S		6/36



**Automobile circuit tester**  
S0011



ITEM NO.	SIZE	BOX(CTN/PCS)
S0011		12/300

**Ball joint separator** | S0019 S0020

Chrome vanadium steel drop forged  
For removal of ball joints  
Fork width: 17mm



ITEM NO.	SIZE	BOX(CTN/PCS)
S0019-17	17mm	-
S0019-20	20mm	-

Two-stage operating design suits most ball joints in steering and suspension  
Offset lever provides maximum jaw opening at 30mm & 56mm  
Fork width: 22mm



ITEM NO.	SIZE	BOX(CTN/PCS)
S0020		-

**Coil spring clamp**  
S0022

Jaws made of chrome vanadium steel  
Poles made of carbon steel heat treated  
Used to clamp coil spring suder wheel cover



ITEM NO.	SIZE	BOX(CTN/PCS)
S0022-270	270mm	-
S0022-370	370mm	-

**Bearing separator set** | S0017

Bearing separator & bolts 1 set  
(415 drop forged hardened 42°-45° capacity 30mm-50mm)  
Bearing separator & bolts 1 set  
(415 drop forged hardened 42°-45° capacity 5mm-75mm)  
Main rod 4 pieces (hex bar 17mm 3/8"x127mmx16t)  
Extension rod 4 pieces  
(hex bar 14mm 3/8"x102mmx16t)  
Beam 1 piece (carbon steel)  
Center bolt 1 piece(9/16x175x10t/inch carbon steel)



ITEM NO.	SIZE	BOX(CTN/PCS)
S0017	30-75mm	1/4

**Hydraulic jack** | S0026



Never exceed the jack's rated load capacity  
Base of jack should always rest on a firm, level surface  
Improper use of this jack may result in loss of load, damage to the jack and/or personal injury

ITEM NO.	SIZE	BOX(CTN/PCS)
S0026-02	2T	
S0026-03	3T	
S0026-05	5T	
S0026-08	8T	
S0026-10	10T	
S0026-16	16T	
S0026-20	20T	
S0026-32	32T	
S0026-50	50T	



**TOOL KITS**

**K Series**





**8-pc tool kit | K0001**

- 1. Screwdriver  $\Phi$ 5x100mm
- 2. Screwdriver  $\Phi$ 5x100mm
- 3. Utility cutter
- 4. Measuring tape 2mx13mm
- 5. Adjustable wrench 200mm/8"
- 6. Lineman's pliers 175mm/7"
- 7. Voltage tester
- 8. Canvas bag



ITEM NO.	SIZE	BOX(CTN/PCS)
K0001	8-pc set	1/16

**18-pc tool kit | K0002**

- 1. Voltage tester
- 2. Screwdriver  $\Phi$  6x100mm
- 3. Screwdriver  $\Phi$  6x100mm
- 4. Scissors
- 5. Insulating tape
- 6. Flashlight
- 7. Adjustable wrench 200mm/8"
- 8. Claw hammer 8 oz
- 9. Lineman's pliers 175mm/7"
- 10. Point-nosed pliers 150mm/6"
- 11. Measuring tape 2mx13mm
- 12. 6-pc precision screwdriver set
- 13. Canvas bag



ITEM NO.	SIZE	BOX(CTN/PCS)
K0002	18-pc set	1/8

**42-pc electrician's tool kit | K0004**



- 1-claw hammer 8 oz
- 1-lineman's pliers 175mm/7"
- 1-point-nosed pliers 150mm/6"
- 6-pc screwdriver set
- 1-soldering iron 30w
- 1-multi-function scissors 175mm/7"
- 1-electrician's knife
- 1-adjustable wrench 200mm/8"
- 1-crimping pliers
- 1-measuring tape 3m x 16mm
- 1-digital voltage tester
- 9-6.3mm socket: 4/5/6/7/8/9/10/11/12/13mm
- 8-pc ball point hex key set long arm
- 1-spinner handle
- 8-screwdriver set:  $\Phi$ 6 x 150mm  $\Phi$ 6 x 150mm,  $\Phi$ 5 x 100mm  $\Phi$ 5 x 100mm,  $\Phi$ 3 x 150mm  $\Phi$ 3 x 150mm,  $\Phi$ 3 x 75mm  $\Phi$ 3 x 75mm

ITEM NO.	SIZE	BOX(CTN/PCS)
K0004	42-pc set	1/6

**59-pc electrician's tool kit | K0005**



- Screwdrivers  $\Phi$ 5x100mm  $\Phi$ 5x100mm
- Machinist's hammer
- Crimping pliers
- Diagonal cutting pliers
- Point-nosed pliers
- Multimeter
- 6-pc precision screwdriver
- Measuring tape 2mx13mm
- Hacksaw frame
- Insulating tape
- Adjustable wrench 200mm/8"
- 8-pc ball point hex key set long arm
- Voltage tester
- Rosin core solder
- Utility cutter
- Flashlight
- Soldering iron
- Tweezers
- Spinner handle
- 2-pc needle files
- Bit adapter
- Soldering iron stand
- 22-pc bits
- Blow case

ITEM NO.	SIZE	BOX(CTN/PCS)
K0005	59-pc set	1/6

**18-pc socket kit | K0007**

1/2"DR.

- Ratchet handle
- Sliding T-bar 1/2drx10
- Ext bar 1/2drx21mm
- Spark plug 1/2drx5
- 13-pc socket 6pt: 1/2drx8 10 11 12 13 14 15 16 17 18 19 22 24mm
- Blow mold case



ITEM NO.	SIZE	BOX(CTN/PCS)
K0007	16-pc set	1/5

**32-pc socket kit | K0008**

1/2"DR.

- Universal joint
- Adapter
- 2-pc extension bar 5" 10"
- 2-pc spark plug: 16 21mm
- 6-pc socket 12pt: 10/12/14/15/17/19mm
- 19-pc socket 6pt: 8/9/10/11/12/13/14/15/16/17/18/19/20 /21/22/24/24/30/32mm
- Blow mold case



ITEM NO.	SIZE	BOX(CTN/PCS)
K0008	32-pc set	1/4

**Socket set | K0009 K0010 K0108 K0015**

**18-PC SET 1/2"DR.**



- 1/2"dr. sockets: 8/10/11/12/13/14/15/17/19/21/22/23/27mm
- 1/2"dr. Deep socket: 21mm
- 1/2"dr. Sliding T bar: 250mm
- 1/2"dr. Extension bar: 120mm
- 1/2"dr. Ratchet handle: 1/2"x250mm
- Metal case: 370x150x50mm

ITEM NO.	SIZE	BOX(CTN/PCS)
K0009	18-pc set	1/10

**26-PC SET 1/2"DR.**



- 1/2"dr. sockets: 10/11/12/13/14/15/16/17/18/19/20/21/22/23/24/26/27/28/30/21mm
- 1/2"dr. Deep socket: 16/21mm
- 1/2"dr. Sliding T bar: 250mm
- 1/2"dr. Universal joint
- 1/2"dr. Extension bar: 5" 10"
- 1/2"dr. Ratchet handle: 1/2"x250mm
- Metal case: 370x150x50mm

ITEM NO.	SIZE	BOX(CTN/PCS)
K0010	26-pc set	1/4

**32-PC SET 1/2"DR.**



- 22-1/2"dr. 12pt. Reg. sockets: 8/9/10/11/12/13/14/15/16/17/18/19/20/21/22/23/24/26/27/28/30/21mm
- 3-1/2"dr. Extension bars: 3" 5" 10"
- 1-Adapter 3 way: F1/2-M3/8
- 1-Screwdriver: 52mm
- 1-1/2"dr. Universal joint
- 1-1/2"dr. Ratchet handle
- 2/1/2"dr. Spark plug sockets: 16mm 21mm
- 1-1/2"dr. L-type handle: 10"

ITEM NO.	SIZE	BOX(CTN/PCS)
K0108	32-pc set	1/4

**82-PC SET 1/2"DR. + 1/4"DR.**



- 7-1/4" dr. 6pt. reg. socket: 7-8-9-10-11-12-13mm
- 3-1/4"dr. Bit socket: FD4-5.5-7mm
- 2-1/4"dr. Bit socket: PH#1-#2
- 2-1/4"dr. Bit socket: PZ#1-#2
- 4-1/4"dr. Bit socket: HW3-4-5-6mm
- 7-1/4"dr. Bit socket: TX8-10-15-20-25-30-10mm
- 1-1/4"dr. Ratchet handle
- 2-1/4"dr. Extension bar: 2" 4"
- 1-1/4"dr. Universal joint
- 1-1/4"dr. Spinner handle
- 1-1/4"dr. Flexible spinner handle
- 1-1/4"dr. Sliding bar
- 15-1/2"dr. 6pt. reg. socket: 8-10-12-13-14-15-16-17-18 -19-22-24-27-30-32mm
- 1-1/2"dr. Ratchet handle
- 2-1/2"dr. Extension bar: 5" 10"
- 1-1/2"dr. Universal joint
- 2-1/2"dr. Spark plug socket: 16-21mm
- 1-3/8"dr. 3 way adapter 3/8"Fx1/2" M
- 3-8mm Bit: FD8-10-12mm
- 2-8mm Bit: PH#3-#4
- 2-8mm Bit: PZ#3-#4
- 4-8mm Bit: HW8-10-12-14mm
- 4-8mm Bit: TX40-45-50-55
- 11-Combination wrench: 8-10-11-12-13-14-15-16-17-18-19mm

ITEM NO.	SIZE	BOX(CTN/PCS)
K0015	82-pc set	1/2



### Socket set | K0017 K0171 | 1/2"DR.+1/4"DR.+3/8"DR.



- 10-1/4"dr. 6pt. Reg. socket: 4/5/6/7/8/9/10/11/12/13mm
- 10-1/4"dr. 6pt. reg. socket: 5/32", 3/6", 4/32, 1/4", 9/32", 5/16", 11/32", 3/8", 7/16", 1/2"
- 4-1/4"dr. 6pt. reg. socket: 8/9/10/12mm
- 11-3/8"dr. 6pt. reg. socket: 9/10/11/12/13/14/15/16/17/18/19mm
- 9-3/8"dr. 6pt. reg. socket: 3/8", 7/16", 1/2", 9/16", 5/8", 11/16", 3/4", 13/16", 7/8"
- 4-3/8"dr. 6pt. deep socket: 13/14/15/17mm
- 8-3/8"dr. star socket: E8, E10, E11, E12, E14, E16, E18, E20
- 7-1/2"dr. 6pt. reg. socket: 20/21/22/24/27/30/32mm
- 4-1/2"dr. 6pt. reg. socket: 15/16", 1", 1-1/16", 1-1/4"
- 4-1/2"dr. Imp. reg. socket: 17/19/21/23mm
- 17-3/8"dr. Bit socket: PH-#1, PH-#2, PZ-#1, PZ-#2, HW-3, HW-4, HW-5, HW-6, FD-5.5, FD-6.5, TX-20, TX-30, TX-40, TX-45, TX-50, TX-55, TX-60
- 10-1/4"dr. Bit x 25mm L: PH-#1, PH-#2, PH-#3, TX-10, TX-15, TX-20, TX-25, TX-27, TX-30, TX-40
- 1-1/4"dr. Extension bar: 2"
- 2-3/8"dr. Extension bar: 3" 6"
- 2-1/2"dr. Extension bar: 5" 10"
- 1-1/4"dr. Universal joint
- 1-3/8"dr. Universal joint
- 1-1/2"dr. Universal joint
- 1-1/4"dr. Extension spinner handle
- 1-1/4"dr. Ratchet handle 45T
- 1-3/8"dr. Ratchet handle 45T
- 1-1/2"dr. Ratchet handle 45T
- 1-1/4"dr. Coupler adapter 1/4x1/4"
- 2-3/8"dr. Spark plug socket: 16 21mm
- 11-comination wrench:
- 8/9/10/11/12/13/14/16/17/18/19mm

ITEM NO.	SIZE	BOX(CTN/PCS)
K0017	120-pc set	1/2



- 10-1/4"dr. 6pt. reg. sockets: 4/5/6/7/8/9/10/11/12/13mm
- 4-1/4"dr. 6pt. deep sockets: 8/9/10/12mm
- 1-1/4"dr. Ratchet handle
- 1-1/4"dr. Extension bar 2"
- 1-1/4"dr. Universal joint
- 1-1/4"dr. Hexagon bit coupler
- 1-1/4"dr. Spinner handle
- 7-1/4"dr. Bits: T10-T15-T20-T25-T27-T30-T40
- 11-3/8"dr. 6pt. reg. sockets: 12/14/15/17mm
- 8-3/8"dr. Star reg. sockets: E8 E10 E11 E12 E14 E16 E18 E20
- 2-3/8"dr. Bit sockets: FD5.5 FD6.5mm
- 2-3/8"dr. Bit sockets: PH1 PH2
- 2-3/8"dr. Bit sockets: Pz1 Pz2
- 4-3/8"dr. Bit sockets: HW3-4-5-6mm
- 7-3/8"dr. Bit sockets: TX20-30-40-45-50-55-60
- 1-3/8"dr. Ratchet handle
- 2-3/8"dr. Extension bar: 3" 6"
- 2-3/8"dr. Spark plug socket: 16 21mm
- 1-3/8"dr. Universal joint
- 7-1/2"dr. 6pt. reg. metric sockets: 20/21/22/24/27/30/32mm
- 1-1/2"dr. Ratchet handle
- 2-1/2"dr. Extension bar: 5" 10"
- 1-1/2"dr. Universal joint
- 11-Combination wrenches: 8/10/11/12/13/14/15/16/17/18/19mm
- 1-3/8" Fx1/4"m adapter
- 1-3/8" Fx1/2"m adapter
- 1-Oil filter wrench 63-102mm
- 1-1/2"dr. Torx bit socket T52
- 1-Electric circuit tester: 6V/12V/24V
- 9-Hex key wrenches: 1.5/2/2.5/3/4/5/6/8/10mm
- 2-Screwdriver: 6x100mm 2x100mm
- 18-6.3mm Bits: FD4-5.5-6.5, PH1-2 PZ1-2, HW3-4-5-6, TX10-15-20-25-27-30-40

ITEM NO.	SIZE	BOX(CTN/PCS)
K0171	121-pc set	1/2

### 1/4"DR.

- 14-1/4"dr. reg. sockets: 3.5/4.0/4.5/5.0/5.5/6.0/7.0/8.0/9.0/10.0/11.0/12.0/13.0/14.0mm
- 18-bit Sockets: FD-4, FD-5.5, FD-6.5, PH-1, PH-2, PZ-1, PZ-2, HW-03, HW-04, HW-05, HW-06, HW-08, TX-10, TX-15, TX-20, TX-25, TX-30, TX-40
- 2-Extension bar: 2" 4"
- 1-Ratchet handle
- 1-Sliding T bar
- 1-Universal joint
- 1-Spinner handle



ITEM NO.	SIZE	BOX(CTN/PCS)
K0019	38-pc set	1/2

### 3/8"DR.

- 18-3/8"dr. reg. sockets: 6/7/8/9/10/11/12/13/14/15/16/17/18/19/20/21/22/24mm
- 9-3/8"dr. deep sockets: 8/10/11/12/13/14/15/17/19mm
- 24-bit sockets: FD-4, FD-5.5, FD-7, PH-1, PH-2, PZ-1, PZ-2, PZ-3, HW-03, HW-04, HW-05, HW-06, HW-07, HW-08, HW-10, TX-10, TX-15, TX-20, TX-25, TX-30, TX-40, TX-45, TX-50, TX-55
- 2-Extension bar: 3" 10"
- 1-Ratchet handle
- 1-Spark plug socket: 16 21mm
- 1-Universal joint
- 1-1/2"Fx3/8"m 3 way adapter



ITEM NO.	SIZE	BOX(CTN/PCS)
K0020	58-pc set	1/5

### 26-pc socket set | K0022

#### 3/4"DR.

- 1-20" Sliding T handle
- 1-8" Extension 1-Adapter
- 16-3/4"dr. sockets: 21/22/23/24/26/27/28/29/30/31/32/34/36/38/41/46mm
- 4-1"dr. sockets: 50/55/60/65mm
- 1-20" Extension bar
- 1-5" L handle
- 1-3/4"dr. Reversible ratchet



ITEM NO.	SIZE	BOX(CTN/PCS)
K0022	26-pc set	1/2

### Bit assortment - 40pc set | K0021

- 7-H10x30L: H4 H5 H6 H7 H8 H10 H12
- 7-H10x75L: H4 H5 H6 H7 H8 H10 H12
- 5-H10x30L: M5 M6 M8 M10 M12
- 5-H10x75L: M5 M6 M8 M10 M12
- 7-H10x30L: T20 T25 T30 T40 T50 T55
- 7-H10x75L: T20 T25 T30 T40 T50 T55
- 1-3/8"dr. Coupler
- 1-1/4"dr. Coupler



ITEM NO.	SIZE	BOX(CTN/PCS)
K0021	40-pc set	1/10

### 21-pc socket kit | K0023

#### 1"DR.

- 1-20" Sliding T handle
- 1-8" Extension 1-Adapter
- 1-16" Extension bar
- 1-1"dr. Reversible ratchet
- 16-1"dr. Sockets: 30/31/32/34/36/38/41/46/48/50/55/60/65/70/75/80mm



ITEM NO.	SIZE	BOX(CTN/PCS)
K0023	21-pc set	1/1

### 24-pc socket set | K0030

#### 1/2"DR. 10-32mm

- 18 pcs blue ribbon sockets
- 1 pc sliding T handle
- 1 pc spark plug socket
- 2 pcs extension bars: 5" 10"
- 1 pc ratchet handle
- 1 pc F handle, flexible head
- All 1/2" drive



ITEM NO.	SIZE	BOX(CTN/PCS)
K0030	24-pc set	1/5

### 12-pc socket wrench set | K0024 K0025 K0026

#### 1/2"DR.

- Sizes: 10,11,12,13,14,15,17,19,22,24mm
- Includes 1PC 1/2" extension bar 5"
- Includes 1PC 1/2" 24 teeth ratchet handle
- Knurled sockets to provide added grip
- Chrome vanadium steel for extra strength



ITEM NO.	SIZE	BOX(CTN/PCS)
K0024	12-pc set	4/16

#### 3/8"DR.

- Sizes: 8, 10, 11, 12, 13, 14, 15, 16, 17, 19mm
- Includes 1PC 3/8" extension bar 6"
- Includes 1PC 3/8" 24 teeth ratchet handle
- Knurled sockets to provide added grip
- Chrome vanadium steel for extra strength



ITEM NO.	SIZE	BOX(CTN/PCS)
K0025	12-pc set	6/24

#### 1/4"DR.

- Sizes: 4, 5, 6, 7, 8, 9, 10, 11, 12, 13mm
- Includes 1PC 1/4" extension bar 6"
- Includes 1PC 1/4" 24 teeth ratchet handle
- Knurled sockets to provide added grip
- Chrome vanadium steel for extra strength



ITEM NO.	SIZE	BOX(CTN/PCS)
K0026	12-pc set	4/48



### Ratchet wrench & bit set

72 teeth  
Chrome Vanadium Steel

**K0029-A**  
**K0029-B**  
**K0029-C**

1pcs Ratch Wrench (14 & 19mm)  
10pcs Socket : 8-9-10-11-12-13-15-16-17-18mm  
1 pc bit adaptor      24 pcs 1/4 bits

Fixed head



Flexible head



Reversible



ITEM NO.	SIZE	BOX(CTN/PCS)
K0029-A	Fixed head	5/20

ITEM NO.	SIZE	BOX(CTN/PCS)
K0029-B	Flexible head	5/20

ITEM NO.	SIZE	BOX(CTN/PCS)
K0029-C	Reversible	5/20

### 28-pc auto-use repair set

**K0006**

1pc T shape screwdriver handle  
1pc 1/4"25mm adapter  
1pc magnetic extension  
16 x bits 25 mm:  
4 x Phillips: PH0 - PH1 - PH2 - PH3  
4 x Pozzi: PZ0 - PZ1 - PZ2 - PZ3  
5 x Torx: T10 - T15 - T20 - T25 - T30  
3 x Slotted: 4mm-5mm-6mm  
include storage box



ITEM NO.	SIZE	BOX(CTN/PCS)
K0006	28-pc set	6/24

### 25-pc t-handle socket & bit set

**K0006A** | ⊕ ⊖ ⊙ ⊛



Stronger handle for better grip  
Plastic case for storage

ITEM NO.	SIZE	BOX(CTN/PCS)
K0006A	25-pc set	6/24

### Flaring tool set | **K0031**

Tube cutter: 3-28mm  
Pipe holding bars:  
14, 12, 8, 6, 10, 15mm  
16, 5, 3, 19mm  
Flaring bits:  
3-5mm, 5-6mm,  
8-10mm, 10-12mm



ITEM NO.	SIZE	BOX(CTN/PCS)
K0031		1/-

### Socket/bit set---ratchet handle

**K0027** | ⊖ ⊕ ⊙ ⊛

1pc mini ratchet T-handle.  
1pc 25mm adaptor.  
1pc magnetic extension shaft.  
3pcs slotted: 3.0, 5.0, 6.0mm.  
3pcs philips: ph1, ph2, ph3.  
3pcs torx: t10, t15, t20  
6pcs sockets: 5, 6, 7, 8, 9, 10mm



ITEM NO.	SIZE	BOX(CTN/PCS)
K0027	18-pc set	6/48

### Bits and sockets set with ratchet handle

**K0027A**  
**K0032**

**36-PC SET**

25pc 6.3x25mm CR-V bits:  
-3, -5, -6 PH0, PH1, PH2, PH3  
PZ0, PZ1, PZ2, PZ3  
T10, T15, T20, T25, T27, T30, T40  
H1.5, H2, H2.5, H3, H4, H5, H6  
9 pc 1/4dr. sockets:  
4, 5, 6, 7, 8, 9, 10, 11, 12mm  
1 pc 6.3x25mm socket adaptor  
1 pc ratchet handle



ITEM NO.	SIZE	BOX(CTN/PCS)
K0027A	36-pc set	1/-

**57-PC SET**

23pc 6.3x25mm CR-V bits :  
-3, -4, -5, -6 PH1, PH2x3, PH3 H3, H4, H5, H6  
PZ1, PZ2, PZ3 T10, T15, T20, T25, T27, T30, T40  
20pc 4x28mm CR-V bits:  
-1.5, -2.0, -2.5, -3.0 PH000, PH00, PH0, PH1  
T6, T7, T8, T9, T10, T15, T20 H1.5, H2.0, H2.5, H3.0, H4.0  
1pc 6.3x25mm socket adaptor  
9pc 1/4dr. sockets: 4, 5, 6, 7, 8, 9, 10, 11, 12mm  
1pc 6.3x50mm extension bar  
1pc 4x60mm extension bar  
1pc 6.3mm drive ratchet handle  
1pc 4mm drive precision screwdriver



ITEM NO.	SIZE	BOX(CTN/PCS)
K0032	57-pc set	1/-





# CUTTING TOOLS

## A Series



**Utility cutter** | **A0001** **A0005**  
**A0002** **A0009**  
**A0004** **A0007** | **100x18x0.5mm**



All new abs handle, metal shaft

ITEM NO.	SIZE	BOX(CTN/PCS)
A0001	100x18x0.5mm	12/96



All new abs handle, metal shaft

ITEM NO.	SIZE	BOX(CTN/PCS)
A0002	100x18x0.5mm	12/96



All new abs handle, metal shaft

ITEM NO.	SIZE	BOX(CTN/PCS)
A0004	100x18x0.5mm	12/96

Auto-loading utility knife  
5 blades stored inside  
Automatic blade loading mechanism  
Positive blade locking at any position

**5 BLADES**  
**SELF LOADING**



ITEM NO.	SIZE	BOX(CTN/PCS)
A0005	100x18x0.5mm	12/96

ABS case and super high carbon steel blades.  
Hardness of blades: hrc55-58.



ITEM NO.	SIZE	BOX(CTN/PCS)
A0009	100x18x0.5mm	24/288

Heavy duty utility knife  
All new abs handle, metal shaft

MAGNET

**127x25x0.7mm**



ITEM NO.	SIZE	BOX(CTN/PCS)
A0007	127x25x0.7mm	12/72

**Light duty utility cutter** | **A0008**  
**A0008N**  
**A0010** | **80x9x0.4mm**



ABS case, stainless steel shaft

ITEM NO.	SIZE	BOX(CTN/PCS)
A0008	80x9x0.4mm	20/400



Chrome-plated flute, ABS case and high carbon steel blade

ITEM NO.	SIZE	BOX(CTN/PCS)
A0008N	80x9x0.4mm	20/400



Stainless steel case

ITEM NO.	SIZE	BOX(CTN/PCS)
A0010	80x9x0.4mm	16/160

**Utility cutter set** | **A0002+10** **A0004+10** **A0408+20**



All new abs handle, metal shaft,  
with a 10-pc tube of cutter blades free

ITEM NO.	SIZE	BOX(CTN/PCS)
A0002+10	100x18x0.5mm	12/96



All new abs handle, metal shaft,  
with a 10-pc tube of cutter blades free

ITEM NO.	SIZE	BOX(CTN/PCS)
A0004+10	100x18x0.5mm	12/96



Steel flute chrome plated;  
ABS case and super high carbon steel blades.

ITEM NO.	SIZE	BOX(CTN/PCS)
A0408+20	100x18x0.5mm 80x9x0.4mm	12/96



Utility knife--zinc alloy | A0012 A0015 A0011



Zinc alloy construction, extra blades installed inside case

ITEM NO.	SIZE	BOX(CTN/PCS)
A0012	60x19x0.6mm	12/96



Zinc alloy handle and super high carbon steel blades.  
Hardness of blades: HRC 61-62°

ITEM NO.	SIZE	BOX(CTN/PCS)
A0015	100x18x0.5mm	12/96



ITEM NO.	SIZE	BOX(CTN/PCS)
A0011	100x18x0.5mm	12/96

Foldable utility knife  
A0006



Zinc alloy construction, extra blades installed inside case

ITEM NO.	SIZE	BOX(CTN/PCS)
A0006		12/96

Plastic cutter  
A0003



Abs case, stainless steel shaft with 3 pcs of extra blades stored inside handle

ITEM NO.	SIZE	BOX(CTN/PCS)
A0003		10/120

Plastic cutter blade  
A0003B



ITEM NO.	SIZE	BOX(CTN/PCS)
A0003B		5/60/3600

Cutter blade | A0041 A0042 A0041B A0043 A0041C A0044 A0441

SK5

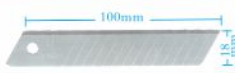

Blade size: 100x18x0.5mm

ITEM NO.	SIZE	BOX(CTN/PCS)
A0041-07	7 Segemnts	200/2400
A0041-14	14 Segemnts	200/2400

SK7



Blade size: 100x18x0.5mm

ITEM NO.	SIZE	BOX(CTN/PCS)
A0041B-07	7 Segemnts	200/2400
A0041B-14	14 Segemnts	200/2400

High carbon steel



Blade size: 100x18x0.5mm

ITEM NO.	SIZE	BOX(CTN/PCS)
A0041C-07	7 Segemnts	200/2400
A0041C-14	14 Segemnts	200/2400

High carbon steel



ITEM NO.	SIZE	BOX(CTN/PCS)
A0042	80x9x0.4mm	200/2400

SK5



ITEM NO.	SIZE	BOX(CTN/PCS)
A0043	127x25x0.7mm	200/1600

High carbon steel



ITEM NO.	SIZE	BOX(CTN/PCS)
A0044	60x19x0.6mm	200/2400

High carbon steel



ITEM NO.	SIZE	BOX(CTN/PCS)
A0441	60x19x0.6mm	200/2400

14-pc precision carving knife set | A0301-14 A0302

SK5

Sk5 blades for maximum sharp  
Soft grip for more comfirt  
Ideal tool set for trimming,deburring, chiseling,carving,cutting and other hobby craftwork



ITEM NO.	SIZE	BOX(CTN/PCS)
A0301-14	14-pc set	1/2

SK5

Sk5 blades for maximum sharp  
Soft grip for more comfirt  
Ideal tool set for trimming,deburring,chiseling, carving,cutting and other hobby craftwork



ITEM NO.	SIZE	BOX(CTN/PCS)
A0302	14-pc set	10/40

Electrician's knife | A0048 A0481 A0049 A0491

Imported stainless steel  
Imported hard black wood  
Stainless steel, heat-treated,  
hardwood handle, foldable  
blade hardness: 50-52°



ITEM NO.	SIZE	BOX(CTN/PCS)
A0048	Straight blade	12/96
A0049	Curved blade	12/96

Imported stainless steel  
Imported hard red wood  
Stainless steel, heat-treated,  
hardwood handle, foldable  
blade hardness: 50-52°

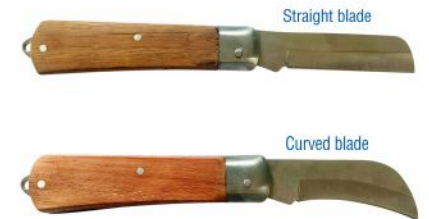

ITEM NO.	SIZE	BOX(CTN/PCS)
A0481	Straight blade	12/96
A0491	Curved blade	12/96

Bolt clippers | A0074 A0741 A0074B

CR.MO.



Drop forged from cr.mo. steel

ITEM NO.	SIZE	BOX(CTN/PCS)
A0074-12	300mm/12"	1/20
A0074-14	350mm/14"	1/10
A0074-18	450mm/18"	1/10
A0074-24	600mm/24"	1/8
A0074-30	750mm/30"	1/5
A0074-36	900mm/36"	1/4
A0074-42	1050mm/42"	1/2
A0074-48	1200mm/48"	1/2

CR.MO.



Drop forged from cr.mo. steel

ITEM NO.	SIZE	BOX(CTN/PCS)
A0074B-18	450mm/18"	-/40
A0074B-24	600mm/24"	-/16
A0074B-30	750mm/30"	-/16
A0074B-36	900mm/36"	-/9
A0074B-42	1050mm/42"	-/9
A0074B-48	1200mm/48"	-



Hardness of material to be cut does not exceed hrc30°

Drop forged from high carbon steel

ITEM NO.	SIZE	BOX(CTN/PCS)
A0741-12	300mm/12"	1/30
A0741-14	350mm/14"	1/30
A0741-18	450mm/18"	1/30
A0741-24	600mm/24"	1/20
A0741-30	750mm/30"	1/10
A0741-36	900mm/36"	1/5
A0741-42	1050mm/42"	1/5
A0741-48	1200mm/48"	1/3



### Mini bolt clippers A0072 A0073



Drop forged from chrome vanadium steel  
Cutting capacity: soft wire ≤3.5mm hard wire ≤2mm

ITEM NO.	SIZE	BOX(CTN/PCS)
A0072-08	200mm/8"	12/48
A0073-08	200mm/8"	12/48

### Ratchet cable cutters | A0075



ITEM NO.	CUTTING CAPACITY	SIZE	BOX(CTN/PCS)
A0075-180	180mm <sup>2</sup>	180mm	1/20
A0075-240	240mm <sup>2</sup>	260mm	1/20
A0075-400	400mm <sup>2</sup>	300mm	1/10

### Cable cutter | A0077 A0177 A0078

CR-V.  
Drop forged from chrome vanadium steel



ITEM NO.	SIZE	CUTTING CAPACITY	BOX(CTN/PCS)
A0077-06	150mm/6"	10mm <sup>2</sup>	12/96
A0077-08	200mm/8"	20mm <sup>2</sup>	6/48
A0077-10	250mm/10"	38mm <sup>2</sup>	6/48

CR-V.  
Drop forged from chrome vanadium steel



ITEM NO.	SIZE	CUTTING CAPACITY	BOX(CTN/PCS)
A0177-10	250mm/10"	60mm <sup>2</sup>	6/48

Steel pipe



ITEM NO.	SIZE	CUTTING CAPACITY	BOX(CTN/PCS)
A0078-24-A	600mm/24"	250mm <sup>2</sup>	1/10
A0078-24-S	600mm/24"	250mm <sup>2</sup>	1/6
A0078-36	900mm/36"	325mm <sup>2</sup>	1/4

Drop forged from chrome vanadium steel

### Wire rope cutter A0076



Hardness of material to be cut does not exceed hrc30°

Drop forged from chrome vanadium steel

ITEM NO.	SIZE	CUTTING CAPACITY	BOX(CTN/PCS)
A0076-08	200mm/8"	6mm	12/48
A0076-24	600mm/24"	12mm	1/6
A0076-36	900mm/36"	14mm	1/4

### Steel tape cutter A0071-18



ITEM NO.	SIZE	BOX(CTN/PCS)
A0071-18	450mm/18"	-

### High carbon steel wood chisel | A0188



ITEM NO.	SIZE	BOX(CTN/PCS)
A0188-3/8	3/8"--10.0mm	12/72
A0188-1/2	1/2"--12.5mm	12/72
A0188-5/8	5/8"--15.6mm	12/72
A0188-3/4	3/4"--19.0mm	12/72
A0188-1	1"--25.0mm	12/72
A0188-1-1/4	1-1/4"--31.0mm	12/72
A0188-1-1/2	1-1/2"--37.5mm	12/72

### Cold chisel | A0288

CR-V.



ITEM NO.	SIZE	BOX(CTN/PCS)
A0288-150	150mm	6/96
A0288-200	200mm	6/60
A0288-250	250mm	6/48

### Hacksaw frame blade | A0090 A0901

SK4



Hard & flexible 彈性

ITEM NO.	SIZE	BOX(CTN/PCS)
A0090-18	18T 300mm/12"	100/1000
A0090-24	24T 300mm/12"	100/1000
A0090-32	32T 300mm/12"	100/1000

Bi-metal



Flexible 柔性

ITEM NO.	SIZE	BOX(CTN/PCS)
A0901-18	18T 300mm/12"	100/1000
A0901-24	24T 300mm/12"	100/1000
A0901-32	32T 300mm/12"	100/1000

### Hacksaw frame | A0089 A0189 A0289



Heavy duty

All metal construction for heavy duty performance

ITEM NO.	SIZE	BOX(CTN/PCS)
A0089	300mm/12"	6/24



Improved model

Aluminum handle & steel pipe chrome plated

ITEM NO.	SIZE	BOX(CTN/PCS)
A0189	300mm/12"	12/36



Double colour aluminum handle  
One bi-metal saw blade provided

ITEM NO.	SIZE	BOX(CTN/PCS)
A0289	300mm/12"	6/24



ITEM NO.	SIZE	BOX(CTN/PCS)
A0489	300mm/12"	6/24



ITEM NO.	SIZE	BOX(CTN/PCS)
A0389	150mm/6"	12/120

### Tailoring scissors | A0020 Industrial grade



ITEM NO.	SIZE	BOX(CTN/PCS)
A0020-10	250mm/10"	6/48
A0020-11	275mm/11"	6/48
A0020-12	300mm/12"	6/48

### Tinman's snips | A0095 A0951 A0952

British type



ITEM NO.	SIZE	BOX(CTN/PCS)
A0095-08	200mm/8"	6/72
A0095-10	250mm/10"	6/48
A0095-12	300mm/12"	6/24
A0095-14	350mm/14"	6/24

American type



ITEM NO.	SIZE	BOX(CTN/PCS)
A0951-08	200mm/8"	8/32
A0951-10	250mm/10"	8/32
A0951-12	300mm/12"	8/32

Japan type



Metal handle with plastic grip for comfort.  
Capacity: mild steel 0.9mm, stainless steel 0.6mm in dia. and metal stud and metal runner.

ITEM NO.	SIZE	BOX(CTN/PCS)
A0952-08	200mm/8"	8/64



### Aviation snips | A0096



ITEM NO.	SIZE	BOX(CTN/PCS)
A0096-L		6/36
A0096-R		6/36
A0096-S		6/36

### Heavy duty pvc pipe cutter | A0106 A1106 A0106B A1106B



ITEM NO.	SIZE	BOX(CTN/PCS)
A0106	3-42mm	6/48
A0106B	3-42mm	-
A1106	3-42mm	6/48
A1106B	3-42mm	-

### Conduit pipe cutters | A0105 A0305 A0205



ITEM NO.	SIZE	BOX(CTN/PCS)
A0105	3-30mm	6/48
A0305	3-33mm	6/48
A0205	3-33mm	6/48

### Pipe cutters | A1206 A0206-42 A1306 A0204 A0207-63 A0209 A0104 A0208-75



ITEM NO.	SIZE	BOX(CTN/PCS)
A1206	42mm	10/60
A0204	42mm	10/60
A0104	3-42mm	10/60



ITEM NO.	SIZE	BOX(CTN/PCS)
A0206-42	42mm	12/72
A0207-63	63mm	6/36
A0208-75	75mm	1/12



ITEM NO.	SIZE	BOX(CTN/PCS)
A1306	3-42mm	6/48
A0209	3-42mm	6/48

### Patented pipe cutters | A1404-75 A1704-75 A1704-127 A1704-160 A1104 A1105 A0114



ITEM NO.	SIZE	BOX(CTN/PCS)
A1404-75	25-75mm/1"-3"	6/48
A1704-75	25-75mm	1/20
A1704-127	50-127mm	1/20
A1704-160	80-160mm	1/20
A1104	3-30mm	6/48



ITEM NO.	SIZE	BOX(CTN/PCS)
A1104B	3-30mm	
A1204B	3-30mm	
A1404B	25-75mm	
A1704B-75	25-75mm	
A1704B-127	50-127mm	
A1704B-160	80-160mm	
A0114	3-16mm	12/72
A1105	3-28mm	6/48



**Glass cutter** | A0115 A0116



Screw open end cover

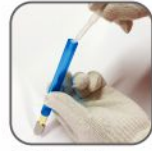

Put into handle kerosene or other suitable lubricants and screw tight cover



Screw open end cover



Put into handle kerosene or other suitable lubricants and screw tight cover

Tungsten carbide cutter wheel for sharpness and durability  
Handle made of impact plastic with metal lid

ITEM NO.	SIZE	BOX(CTN/PCS)
A0115	3-12mm	12/120

Tungsten carbide cutter wheel for sharpness and durability  
Handle made of golden coloured aluminum

ITEM NO.	SIZE	BOX(CTN/PCS)
A0116	5-15mm	12/120

**Hollow punch** | A0107 A0108 A0137

CR-V.



Chrome vanadium steel heat treated

ITEM NO.	SIZE	BOX(CTN/PCS)
A0107-03	3x8x100mm	18/144
A0107-04	4x9x100mm	18/144
A0107-05	5x10x110mm	18/144
A0107-06	6x11x110mm	18/144
A0107-08	8x13x110mm	18/144
A0107-10	10x15x120mm	18/144
A0107-12	12x17x120mm	18/144

**Pin punch**

Chrome vanadium steel heat treated

CR-V.



ITEM NO.	SIZE	BOX(CTN/PCS)
A0108-02	2x10x150mm	10/200
A0108-03	3x10x150mm	10/200
A0108-04	4x10x150mm	10/200
A0108-05	5x10x150mm	10/200
A0108-06	6x12x150mm	10/200
A0108-08	8x12x150mm	10/200

**5pc hollow punch set**

Size: 3mm/4mm/5mm/6mm/8mm



Punching edge finely ground and sharpened for accurate and durable performance  
High carbon steel heat-treated and tempered  
Dented grooves for firm grip

ITEM NO.	SIZE	BOX(CTN/PCS)
A0137	5-pc set	12/72

**6-pc punch set** | A0117

3pc pin punch:  
3x10x15mm  
5x10x150mm  
8x13x150mm  
3pc taper punch:  
3x10x150mm  
5x10x150mm  
8x12x150mm



ITEM NO.	SIZE	BOX(CTN/PCS)
A0117	6-pc set	1/20

**6-pc punch & chisel set**  
A0127

2pc cold chisel:  
15x12x150mm  
11x10x130mm  
1pc pin punch:  
5x12x150mm  
1pc center punch:  
3x10x120mm  
1pc taper punch:  
3x10x120mm  
1pc cape chisel:  
4x10x130mm



ITEM NO.	SIZE	BOX(CTN/PCS)
A0127	6-pc set	1/20

**20pc metric tap and die set** | A1011

Manufactured from Alloy steel

9PC Dies size:

3\*0.5 4\*0.7 5\*0.8  
6\*1.0 7\*1.0 8\*1.25  
10\*1.5 12\*1.75 1/8-27

9PC Taps: size as dies

1PC Tap Wrench

1PC Die handle 1"OD



ITEM NO.	SIZE	BOX(CTN/PCS)
A1011	20-pc set	1/16

**40pc tap and die set-metric and unc** | A1012

Manufactured from alloy steel, Iron case packed

17PC Dies size:

M3\*0.5 M4\*0.7 M5\*0.8  
M6\*1.0 M7\*1.0 M8\*1.25  
M10\*1.5 M12\*1.75

1/8NPT27 4NC40 6NC32  
8NC32 1/4NC20 5/16NC18  
3/8NC16 7/16NC14 1/2NC13

17PC Taps: size as dies

Tap wrench

Die handle: 1" OD

T type tap wrench 1/4" capacity

Screw pitch gauge

Screwdriver



ITEM NO.	SIZE	BOX(CTN/PCS)
A1012	40-pc set	1/12

**5pc spiral fluted screw extractor set** | A0101

1/8"-1/4" | 1/4"-5/16" | 5/16"-7/16" |  
7/16"-9/16" | 9/16"-3/4"



ITEM NO.	SIZE	BOX(CTN/PCS)
A0101	5-pc set	12/96



**Pliers and holding tools**

**B Series**





**Pipe wrench | B0001 B0002 B0004**

**Heavy duty**



Jaws made from high carbon steel, heat treated.  
Selected cast iron handle vinyl dipped for comfort

ITEM NO.	SIZE	MAX WORKING DIA.	BOX(CTN/PCS)
B0001-08	200mm/8"	∅27mm	6/60
B0001-10	250mm/10"	∅34mm	6/48
B0001-12	300mm/12"	∅42mm	6/36
B0001-14	350mm/14"	∅50mm	6/24
B0001-18	450mm/18"	∅60mm	6/12
B0001-24	600mm/24"	∅76mm	5/10
B0001-36	900mm/36"	∅85mm	3/6
B0001-48	1200mm/48"	∅110mm	2/4

**Aluminum handle**



Jaws made of chrome vanadium steel heat treated.  
Aluminum handle for easier operation and added torque

ITEM NO.	SIZE	MAX WORKING DIA.	BOX(CTN/PCS)
B0002-08	200mm/8"	∅27mm	6/48
B0002-10	250mm/10"	∅34mm	6/36
B0002-12	300mm/12"	∅42mm	6/24
B0002-14	350mm/14"	∅50mm	6/24
B0002-18	450mm/18"	∅60mm	-/12
B0002-24	600mm/24"	∅76mm	-/8
B0002-36	900mm/36"	∅85mm	-/4
B0002-48	1200mm/48"	∅110mm	-/2

**Chain pipe wrench**



ITEM NO.	SIZE	MAX WORKING DIA.	BOX(CTN/PCS)
B0004-690	690mm	76mm/3"	-/4
B0004-900	900mm	100mm/4"	-/4
B0004-1000	1000mm	150mm/6"	-/2
B0004-1200	1200mm	200mm/8"	-/2
B0004-1400	1400mm	300mm/12"	-/2

**G type clamp | B0003**



ITEM NO.	SIZE	BOX(CTN/PCS)
B0003-01	25mm/1"	12/144
B0003-02	50mm/2"	12/72
B0003-03	75mm/3"	6/36
B0003-04	100mm/4"	6/36
B0003-05	125mm/5"	6/30
B0003-06	150mm/6"	6/24
B0003-08	200mm/8"	6/12
B0003-10	250mm/10"	5/10
B0003-12	300mm/12"	5/10

**Pump pliers | B0006 B0007 | CR-V.**



Carbon steel drop forged & chrome plated

ITEM NO.	SIZE	BOX(CTN/PCS)
B0006-10	250mm/10"	6/48
B0006-12	300mm/12"	6/36



Carbon steel drop forged & chrome plated

ITEM NO.	SIZE	BOX(CTN/PCS)
B0007-10	250mm/10"	6/48

**Slip joint pliers | B0008**



A: Double colour vinyl dipped handle



B: Bare handle with pressed grooves

ITEM NO.	SIZE	BOX(CTN/PCS)
B0008-06	150mm/6"	12/96
B0008-08	200mm/8"	6/72
B0008-08-ZS	200mm/8"	6/72
B0008-10	250mm/10"	6/48

**Plastic cutting pliers | B0013 B0131 | CR-V.**



Thick type  
10mm

Chrome vanadium steel drop forged & heat treated  
Spring loaded

ITEM NO.	SIZE	BOX(CTN/PCS)
B0013-05	125mm/5"	12/96
B0013-06	150mm/6"	12/96



Thin type  
9mm

Chrome vanadium steel drop forged & heat treated  
Spring loaded

ITEM NO.	SIZE	BOX(CTN/PCS)
B0131-05	125mm/5"	12/96
B0131-06	150mm/6"	12/96

**Diagonal cutting pliers | B0218 B0318 B0418**



Chrome vanadium steel drop forged & heat treated  
Spring loaded

ITEM NO.	SIZE	BOX(CTN/PCS)
B0218-05	125mm/5"	12/108



Chrome vanadium steel drop forged & heat treated

ITEM NO.	SIZE	BOX(CTN/PCS)
B0318-05	130mm/5"	12/108



Chrome vanadium steel drop forged

ITEM NO.	SIZE	BOX(CTN/PCS)
B0418-05	130mm/5"	12/120

**Pliers | B0010 B0011 B0012 B0144 B0154 B0164 B0014 B0015 B0016**

**Lineman's pliers**



**CR-V.**

Chrome vanadium steel drop forged  
Fully hardened, cutting edges induction quenched

ITEM NO.	SIZE	BOX(CTN/PCS)
B0010-08	200mm/8"	6/48

**Point-nosed pliers**



**CR-V.**

Chrome vanadium steel drop forged  
Fully hardened, cutting edges induction quenched

ITEM NO.	SIZE	BOX(CTN/PCS)
B0011-06	150mm/6"	6/72

**Diagonal cutting pliers**



**CR-V.**

Chrome vanadium steel drop forged  
Fully hardened, cutting edges induction quenched

ITEM NO.	SIZE	BOX(CTN/PCS)
B0012-06	150mm/6"	6/72

**Lineman's pliers**



Wire ∅3.4mm Soft wire ∅4.0mm  
Drop forged from chrome vanadium steel  
Cutting edges induction hardened  
Double-color handle

**CR-V.**

ITEM NO.	SIZE	BOX(CTN/PCS)
B0144-06	150mm/6"	6/72
B0144-07	175mm/7"	6/60
B0144-08	200mm/8"	6/48

**Point-nosed pliers**



Wire ∅1.5mm Soft wire ∅2.6mm  
Drop forged from chrome vanadium steel  
Cutting edges induction hardened  
Double-color handle

**CR-V.**

ITEM NO.	SIZE	BOX(CTN/PCS)
B0154-06	150mm/6"	6/72
B0154-08	200mm/8"	6/48

**Diagonal cutting pliers**



Wire ∅1.9mm Soft wire ∅3.2mm  
Drop forged from chrome vanadium steel  
Cutting edges induction hardened  
Double-color handle

**CR-V.**

ITEM NO.	SIZE	BOX(CTN/PCS)
B0164-06	150mm/6"	6/72
B0164-07	175mm/7"	6/60

**Lineman's pliers**



Carbon steel drop forged steel with insulation sleeves

ITEM NO.	SIZE	BOX(CTN/PCS)
B0014-06	150mm/6"	6/72
B0014-07	175mm/7"	6/60
B0014-08	200mm/8"	6/48

**Point-nosed pliers**



Carbon steel drop forged steel with insulation sleeves

ITEM NO.	SIZE	BOX(CTN/PCS)
B0015-06	150mm/6"	6/72
B0015-07	175mm/7"	6/60
B0015-08	200mm/8"	6/48

**Diagonal cutting pliers**



Carbon steel drop forged steel with insulation sleeves

ITEM NO.	SIZE	BOX(CTN/PCS)
B0016-06	150mm/6"	6/72
B0016-07	175mm/7"	6/60
B0016-08	200mm/8"	6/48



**Pliers** | B0141 B0151 B0161  
B0143 B0153 B0163

**Lineman's pliers**



**Ni.Cr.coated**  
Carbon steel drop forged steel with insulation sleeves

ITEM NO.	SIZE	BOX(CTN/PCS)
B0141-08	200mm/8"	6/48

**Point-nosed pliers**



**Ni.Cr.coated**  
Carbon steel drop forged steel with insulation sleeves

ITEM NO.	SIZE	BOX(CTN/PCS)
B0151-06	150mm/6"	6/72

**Diagonal cutting pliers**



**Ni.Cr.coated**  
Carbon steel drop forged steel with insulation sleeves

ITEM NO.	SIZE	BOX(CTN/PCS)
B0161-06	150mm/6"	6/72

**Lineman's pliers**



Drop forged from high carbon steel.  
Cutting edges induction hardened.  
Plastic insulation sleeves

**EURO TYPE**

ITEM NO.	SIZE	BOX(CTN/PCS)
B0143-06	150mm/6"	12/72
B0143-07	175mm/7"	12/60
B0143-08	200mm/8"	12/48

**Point-nosed pliers**



Drop forged from high carbon steel.  
Cutting edges induction hardened.  
Plastic insulation sleeves

**EURO TYPE**

ITEM NO.	SIZE	BOX(CTN/PCS)
B0153-06	150mm/6"	12/72
B0153-07	175mm/7"	12/60
B0153-08	200mm/8"	12/48

**Diagonal cutting pliers**



Drop forged from high carbon steel.  
Cutting edges induction hardened.  
Plastic insulation sleeves

**EURO TYPE**

ITEM NO.	SIZE	BOX(CTN/PCS)
B0163-06	150mm/6"	12/72
B0163-07	175mm/7"	12/60
B0163-08	200mm/8"	12/48

**Multipurpose combination pliers**

Eccentric axial structure makes cutting and clamping 50% easier.

B0054-08 B0054-09  
B0055-09 B0056-08

Wire stripping holes precision machined on a drop forged workpiece makes the function professional level



Wire gauges: 1.5" 2.5" 4" 6" 8"mm  
Cutting capacity:  
Wire rope: 4" 6"mm Steel wire: 1mm 3mm

ITEM NO.	SIZE	BOX(CTN/PCS)
B0054-08	200mm/8"	12/72
B0054-09	225mm/9"	12/60

Wire stripping holes precision machined on a drop forged workpiece makes the function professional level



Wire gauges: 1.5" 2.5" 4" 6" 8"mm  
Cutting capacity:  
Wire rope: 3"mm Steel wire: 2mm

ITEM NO.	SIZE	BOX(CTN/PCS)
B0055-09	225mm/9"	12/72

Wire stripping holes precision machined on a drop forged workpiece makes the function professional level



Wire gauges: 1.5" 2.5" 4" 6" 8"mm  
Cutting capacity:  
Wire rope: 3"mm Steel wire: 2mm

ITEM NO.	SIZE	BOX(CTN/PCS)
B0056-08	200mm/8"	12/72

**Combination pliers** | B0142-08 B0145-08 B0019-10

**Energy saving**

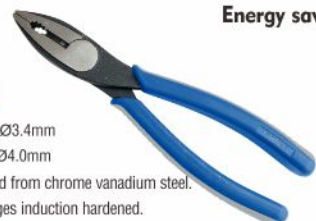

**CR-V.**  
Hard wire: Ø3.4mm  
Soft wire: Ø4.0mm  
Drop forged from chrome vanadium steel.  
Cutting edges induction hardened.  
Plastic insulation sleeves

ITEM NO.	SIZE	BOX(CTN/PCS)
B0142-08	200mm/8"	6/48

**Industrial**



**CR-V.**  
Hard wire: Ø3.4mm  
Soft wire: Ø4.0mm  
Drop forged from chrome vanadium steel.  
Cutting edges induction hardened.  
Plastic insulation sleeves

ITEM NO.	SIZE	BOX(CTN/PCS)
B0145-08	200mm/8"	6/48

**Heavy-duty**



Cutting capacity  
Hard wire: Ø3.4mm  
Soft wire: Ø4.0mm  
Drop forged from high carbon steel.  
Cutting edges induction hardened.  
Plastic insulation sleeves

ITEM NO.	SIZE	BOX(CTN/PCS)
B0019-10	250mm/10"	6/36

**Mini pliers** | B0017-05 B0171-05 B0172-05  
B0173-05 B0018-110 B0181-05  
B0182-110

**Point-nosed pliers**



Carbon steel drop forged & heat treated  
Black nickel finish  
Spring loaded

ITEM NO.	SIZE	BOX(CTN/PCS)
B0017-05	125mm/5"	12/96

**Mini point nose pliers**



Carbon steel drop forged & heat treated  
Black nickel finish  
Spring loaded

ITEM NO.	SIZE	BOX(CTN/PCS)
B0171-05	135mm/5"	12/96

**Mini flat nose pliers**



Carbon steel drop forged & heat treated  
Black nickel finish  
Spring loaded

ITEM NO.	SIZE	BOX(CTN/PCS)
B0172-05	130mm/5"	12/96

**Mini bent nose pliers**



Carbon steel drop forged & heat treated  
Black nickel finish  
Spring loaded

ITEM NO.	SIZE	BOX(CTN/PCS)
B0173-05	130mm/5"	12/96

**Diagonal cutting pliers**



Carbon steel drop forged & heat treated  
Black nickel finish  
Spring loaded

ITEM NO.	SIZE	BOX(CTN/PCS)
B0018-110	110mm	12/96

**Mini combination pliers**



Carbon steel drop forged & heat treated  
Black nickel finish  
Spring loaded

ITEM NO.	SIZE	BOX(CTN/PCS)
B0181-05	125mm/5"	12/96

**Mini end cutters**



Carbon steel drop forged & heat treated  
Black nickel finish  
Spring loaded

ITEM NO.	SIZE	BOX(CTN/PCS)
B0182-110	110mm	12/96

**Circlip pliers**  
High carbon steel

B0022 B0023  
B0024 B0025



External



Internal

Drop forged and heat treated  
Double colour vinyl handle spring loaded

ITEM NO.	SIZE	Specs.	BOX(CTN/PCS)
B0022-05	125mm/5"	Co. steel	12/96
B0022-07	175mm/7"	Co. steel	12/96
B0022-09	225mm/9"	Co. steel	12/72
B0022-13	325mm/13"	Co. steel	-

Drop forged and heat treated  
Double colour vinyl handle spring loaded

ITEM NO.	SIZE	Specs.	BOX(CTN/PCS)
B0023-05	125mm/5"	Co. steel	12/96
B0023-07	175mm/7"	Co. steel	12/96
B0023-09	225mm/9"	Co. steel	12/72
B0023-13	325mm/13"	Co. steel	-

**Circlip pliers set**  
B0026



High carbon steel, heat-treated.  
Spring loaded for easier operation.  
Plastic handle for comfort.  
Always wear eye protection when using tools.  
Effective range: 10-50mm 3/8"-2"

ITEM NO.	SIZE	BOX(CTN/PCS)
B0026-07	175mm/7"	10/60



External

Drop forged and heat treated  
Double colour vinyl handle spring loaded

ITEM NO.	SIZE	Specs.	BOX(CTN/PCS)
B0024-05	125mm/5"	Co. steel	12/96
B0024-07	175mm/7"	Co. steel	12/96
B0024-09	225mm/9"	Co. steel	12/72
B0024-13	325mm/13"	Co. steel	-



Internal

Drop forged and heat treated  
Double colour vinyl handle spring loaded

ITEM NO.	SIZE	Specs.	BOX(CTN/PCS)
B0025-05	125mm/5"	Co. steel	12/96
B0025-07	175mm/7"	Co. steel	12/96
B0025-09	225mm/9"	Co. steel	12/72
B0025-13	325mm/13"	Co. steel	-



Nosed pliers

B0051-11 B0052-11  
B0050 B0053-11

Long-nosed pliers



High carbon steel drop forged & heat treated  
Black phosphated finish

ITEM NO.	SIZE	BOX(CTN/PCS)
B0051-11	275mm/11"	6/36

Bent-nosed pliers 45°



High carbon steel drop forged & heat treated  
Black phosphated finish

ITEM NO.	SIZE	BOX(CTN/PCS)
B0052-11	275mm/11"	6/36

Round-nosed clamping pliers



High carbon steel drop forged & heat treated  
Black phosphated finish

ITEM NO.	SIZE	SIZE	BOX(CTN/PCS)
B0050-05-11	275mm/11	5mm	6/54
B0050-10-11	275mm/11	10mm	6/54
B0050-15-11	275mm/11	15mm	6/54

Bent-nosed pliers 90°



High carbon steel drop forged & heat treated  
Black phosphated finish

ITEM NO.	SIZE	BOX(CTN/PCS)
B0053-11	275mm/11"	6/36

Wire stripping tool

B0030 B0031 B0342

Wire stripper & cutter



2 in 1, wire stripper & cutter  
Applicable wire stripper size: 0.5mm<sup>2</sup>-6mm<sup>2</sup>  
Adjustable stop for consistency in wire strip lengths  
Light, handy and excellent durability

ITEM NO.	SIZE	BOX(CTN/PCS)
B0030	0.5-6mm <sup>2</sup>	10/60

Stripper/cable cutter



16° precision wire stripping  
Black E-coating for rust resistance  
Wire stripping holes precision machined.  
Wire gauges: 1.5<sup>#</sup> 2.5<sup>#</sup> 4<sup>#</sup> 6<sup>#</sup> 8<sup>#</sup>mm  
PP+TPR double colour handles environmental friendly and comfortable to hold

ITEM NO.	SIZE	BOX(CTN/PCS)
B0031	1.5-8mm <sup>2</sup>	12/48

B0342 A		B0342 B		B0342 C	
APPLICABLE AWG SIZES		APPLICABLE AWG SIZES		APPLICABLE AWG SIZES	
STANDARD	SINGLE	STANDARD	SINGLE	STANDARD	SINGLE
24	22	0.6	28	26	0.4
22	20	0.8	26	24	0.5
20	18	1.0	24	22	0.6E
18	16	1.3	22	20	0.8
16	14	1.6	20	18	1.0
14	12	2.0	18	16	1.3
12	10	2.6			2.0

ITEM NO.	SIZE	BOX(CTN/PCS)
B0342 A	A 150mm/6"	12/48
B0342 B	B 150mm/6"	12/48
B0342 C	C 150mm/6"	12/48



Suitable for wire stripping and wire cutting

ITEM NO.	SIZE	BOX(CTN/PCS)
B0029-A	A 0.5-1.0-1.6-2.0mm <sup>2</sup>	8/48
B0029-N	N 0.5-1.2-1.6-2.0-2.6-3.2mm <sup>2</sup>	8/48
B0029-C	C 0.5-1.0-2.5-4.0-6.0mm <sup>2</sup>	8/48

Walnut pliers and cutter | B0027

CR-V.



Chrome vanadium steel drop forged and heat treated  
Double colour vinyl dipped handle

ITEM NO.	SIZE	BOX(CTN/PCS)
B0027-08	200mm/8"	6/48

Automatic wire stripper  
B0028 B0029



Terminal crimping Wire cutting Stripping

ITEM NO.	SIZE	BOX(CTN/PCS)
B0028	0.2-1.5m <sup>2</sup>	8/48



A 0.5-1.0-1.6-2.0mm<sup>2</sup>  
N 0.5-1.2-1.6-2.0-2.6-3.2mm<sup>2</sup>  
C 0.5-1.0-2.5-4.0-6.0mm<sup>2</sup>

Most widely used wire sizes

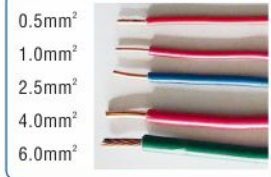

- ※ Blades made of carbon steel, heat treated.
- ※ All metal construction ensures durability and strength.
- ※ Awg size clearly marked at each cutting station.
- ※ Adjustable stripping length guide provides consistent uniform strip length.

ITEM NO.	SIZE	BOX(CTN/PCS)
B0029-A	A 0.5-1.0-1.6-2.0mm <sup>2</sup>	8/48
B0029-N	N 0.5-1.2-1.6-2.0-2.6-3.2mm <sup>2</sup>	8/48
B0029-C	C 0.5-1.0-2.5-4.0-6.0mm <sup>2</sup>	8/48

Wire stripping tool  
B0342-D

For super thin wires



0.05-0.52mm<sup>2</sup>,  
0.2mm(30AWG), 0.3mm(28AWG), 0.4mm(26AWG)  
0.5mm(24AWG), 0.6mm(22AWG), 0.8mm(20AWG)



Carbon steel full Wire stripping of various gauge sizes Wire cutting capacity: 0.5-0.8mm



High carbon steel heat treated. Precision ground stripping holes for accurate performance  
Spring-loaded handle for easy repeated action

ITEM NO.	SIZE	BOX(CTN/PCS)
B0342-D	0.2-0.8mm	12/72

Multi-function crimping tool | B0034 B0341

New model



Suitable for crimping, Wire stripping and wire cutting

ITEM NO.	SIZE	BOX(CTN/PCS)
B0034	250mm/10"	8/64

New model



Suitable for crimping, Wire stripping and wire cutting

ITEM NO.	SIZE	BOX(CTN/PCS)
B0341	250mm/10"	8/64

Ratchet crimping tool | B0043



For various kinds of terminals as shown below  
Jaws interchangeable and replacable

ITEM NO.	SIZE	BOX(CTN/PCS)
B0043-C	C	7/42
B0043-D	D	7/42
B0043-E	E	7/42
B0043-G	G	7/42
B0043-H	H	7/42
B0043-H1	H1	7/42
B0043-I	I	7/42
B0043-J	J	7/42
B0043-M	M	7/42
B0043-N	N	7/42
B0043-W	W	7/42

Applicable range	Description
.256" .319" .068" .213" (6.50/8.10/1.72/5.41mm)	RG 58,59,62,6

Applicable range	Description
.213" .256" .068" .324" (5.41/6.50/1.72/8.23mm)	RG 58,59,62,6

Applicable range	Description
AWG 10 8 6 DIN 6 10 16mm <sup>2</sup>	PIN TERMINAL INSULATED OR NON-INSULATED FERRULES

Applicable range	Description
.043" .068" .100" .137" .213" .255" (1.09/1.72/2.54/3.48/5.41/6.48mm)	RG 58,59,62,174 Fiber Optic.

Applicable range	Description
AWG 22 10 18 16 14 12 DIN 0.5 0.75 1.0 1.5 2.5 4.0mm <sup>2</sup>	PIN TERMINAL INSULATED OR NON-INSULATED FERRULES

Applicable range	Description
AWG 22-20 18-16 14 12 10 DIN 0.5-0.75 1.0-1.5 2.5 4.0 6.0mm <sup>2</sup>	PIN TERMINAL INSULATED OR NON-INSULATED FERRULES

Applicable range	Description
.255" .213" .100" .068" .324" (6.48/5.41/2.54/1.72/8.23mm)	RG 58, 59, 62, 6

Applicable range	Description
AWG 22-18 16-14 12-10 DIN 0.5-1.0 1.5-2.5 4-6mm <sup>2</sup>	FOR INSULATED TERMINAL

Applicable range	Description
AWG 20-18 16-14 12-10 DIN 1.5 2.5 6 10mm <sup>2</sup> JIS 1.25 2.0 5.5mm <sup>2</sup>	INTER-LOCKING & NON-INSULATED

Applicable range	Description
AWG 20-18 16-14 12-10 8 DIN 1.5 2.5 6 10mm <sup>2</sup> JIS 1.25 2.0 5.5 8mm <sup>2</sup>	NON-INSULATED TERMINAL

Applicable range	Description
AWG 22-18 16-14 12-10 8 DIN 0.5-1.0 1.5-2.5 4-6mm <sup>2</sup> JIS 1.25 2.0 5.5mm <sup>2</sup>	VINYL INSULATED W/O COPPER SLEEVE



**Mudular plug crimping tool** | B0032 B0033 B0046 B0042



Suitable for crimping, Wire stripping and wire cutting

ITEM NO.	SIZE	BOX(CTN/PCS)
B0032	8P 8C	12/72



For crimping computer and telephone plugs, with wire cutter

ITEM NO.	SIZE	BOX(CTN/PCS)
B0033	6P 8P	12/48



For crimping modular plugs 4 pins, 6 pins & 8 pins, with wire cutter

ITEM NO.	SIZE	BOX(CTN/PCS)
B0046	6P 8P 4P	6/36



For non0insulated terminals with wire cutter

ITEM NO.	SIZE	BOX(CTN/PCS)
B0042	180mm/7"	12/72

**Self-adjusting crimping pliers** | B0049



B0049-0604 0.25-10mm<sup>2</sup>

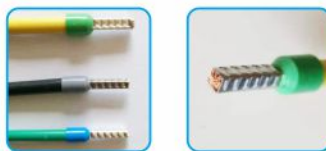

B0049-0606 0.25-6mm<sup>2</sup>

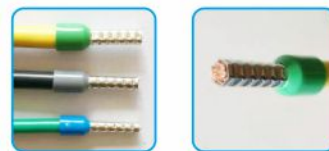

Quadrilateral type



Hexagon type

ITEM NO.	SIZE	BOX(CTN/PCS)
B0049-0604	0.25-10mm <sup>2</sup> AWG23-5	

ITEM NO.	SIZE	BOX(CTN/PCS)
B0049-0606	0.25-6mm <sup>2</sup> AWG23-7	12/72

**Lock-grip pliers**

B0035 B0351 B0036 B0037 B0038 B0039



Chrome vanadium steel drop forged  
Curved jaws with wire cutters  
Nickel plated

CR-V.

ITEM NO.	SIZE	BOX(CTN/PCS)
B0035-07	175mm/7"	6/48
B0035-10	250mm/10"	6/36



Milled teeth for positive grip  
High carbon steel drop forged and heat treated with wire cutter  
Hardened tension bar with toggle mechanism provides secure locking action

ITEM NO.	SIZE	BOX(CTN/PCS)
B0351-10	250mm/10"	6/36



Chrome vanadium steel drop forged  
Curved jaws with wire cutters  
Nickel plated

CR-V.

ITEM NO.	SIZE	BOX(CTN/PCS)
B0036-10	250mm/10"	6/36



Chrome vanadium steel drop forged  
Curved jaws with wire cutters  
Nickel plated

CR-V.

ITEM NO.	SIZE	BOX(CTN/PCS)
B0037-06	150mm/6"	6/72



Chrome vanadium steel drop forged  
Nickel plated

CR-V.

ITEM NO.	SIZE	BOX(CTN/PCS)
B0038-R	Regular 275mm/11"	4/24
B0038-SP	Swivel pads 275mm/11"	4/24

**Locking chain clamp**



Chrome vanadium steel drop forged  
Length of chain can be adjusted when needed

CR-V.

ITEM NO.	SIZE	BOX(CTN/PCS)
B0039-18	450mm/18"	6/24

**Gear pullers** | B0040 B0040A B0041 B0041A



2-jaw gear pullers

CR.V. STEEL

ITEM NO.	SIZE	BOX(CTN/PCS)
B0040-03	75mm/7"	1/20
B0040-04	100mm/4"	1/20
B0040-06	150mm/6"	1/12
B0040-08	200mm/8"	1/5
B0040-10	250mm/10"	1/4
B0040-12	300mm/12"	1/2



3-jaw gear pullers

CR.V. STEEL

ITEM NO.	SIZE	BOX(CTN/PCS)
B0041-03	75mm/7"	1/20
B0041-04	100mm/4"	1/20
B0041-06	150mm/6"	1/10
B0041-08	200mm/8"	1/4
B0041-10	250mm/10"	1/4
B0041-12	300mm/12"	-/1



2-jaw gear pullers

HIGH CARBON STEEL

ITEM NO.	SIZE	BOX(CTN/PCS)
B0040A-03	75mm/7"	1/20
B0040A-04	100mm/4"	1/20
B0040A-06	150mm/6"	1/10
B0040A-08	200mm/8"	1/4
B0040A-10	250mm/10"	1/4
B0040A-12	300mm/12"	-/1



3-jaw gear pullers

HIGH CARBON STEEL

ITEM NO.	SIZE	BOX(CTN/PCS)
B0041A-03	75mm/7"	1/20
B0041A-04	100mm/4"	1/20
B0041A-06	150mm/6"	1/10
B0041A-08	200mm/8"	1/4
B0041A-10	250mm/10"	1/4
B0041A-12	300mm/12"	-/1

**Gear puller-adjustable arms** | B0045



Jaws made of chrome vanadium steel  
Jaws can be set inward or outward

ITEM NO.	SIZE	BOX(CTN/PCS)
B0045-01	1#(80x100)	1/20
B0045-02	2#(120x100)	1/20
B0045-03	3#(150x150)	1/10
B0045-04	4#(200x150)	1/6
B0045-05	5#(250x200)	1/4

**Bearing & shaft sleeve puller** | B0048

- Especially designed to dismount (pull out) bearing or shaft sleeve
- Thin wall hooks to hold workpiece firmly
- Long adjustable arms to reach to otherwise hard-to get areas
- Drop forged from cr.v. Steel, heat treated
- Applicable bearing size: Ø19-35mm



1#



2#



3#

ITEM NO.	SIZE	BOX(CTN/PCS)
B0048-1#	19-35mm	
B0048-2#	24-55mm	
B0048-3#	35-80mm	



### BLADE REPLACEABLE PATENTED PUNCH TOOL

**B0044**

Constructed with heat-treated metal sheet for long time heavy-duty punching.



Round



Our patented blade replacing mechanism greatly prolongs the lifetime of our pliers.

Alloy steel blade uniquely treated and sharpened makes your punch easy and clean.

ITEM NO.	SIZE	BOX(CTN/PCS)
B0044	2.0 2.5 3.0 3.5 4.0 4.5mm	6/48

### Heavy duty hollow punch blades

**B0044B**  
**B0441B**



ITEM NO.	SIZE	BOX(CTN/PCS)
B0044B		5/-
B0441B		5/-

### Hollow punch pliers **B0441**

- Elliptical
- Long square
- Round



Elliptical: 7x5mm  
Round: 3.5 4.0 4.5mm  
Long square: 7x3.5mm 8x4mm

ITEM NO.	SIZE	BOX(CTN/PCS)
B0441		6/48

### Pilot bearing puller **B0047**



**B0047[S0018]**

ITEM NO.	SIZE	BOX(CTN/PCS)
B0047	12-38mm	1/20

### Heavy duty bench vise | **L0058**

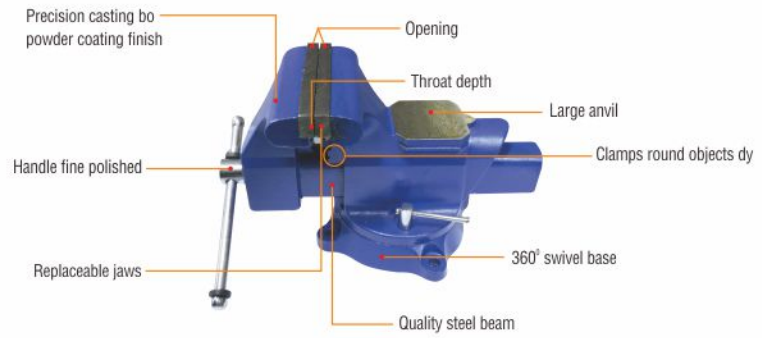

ITEM NO.	SIZE	BOX(CTN/PCS)
L0058-04	100mm/4"	-/2
L0058-05	125mm/5"	-/1
L0058-06	150mm/6"	-/1



## Fastening tools

C Series

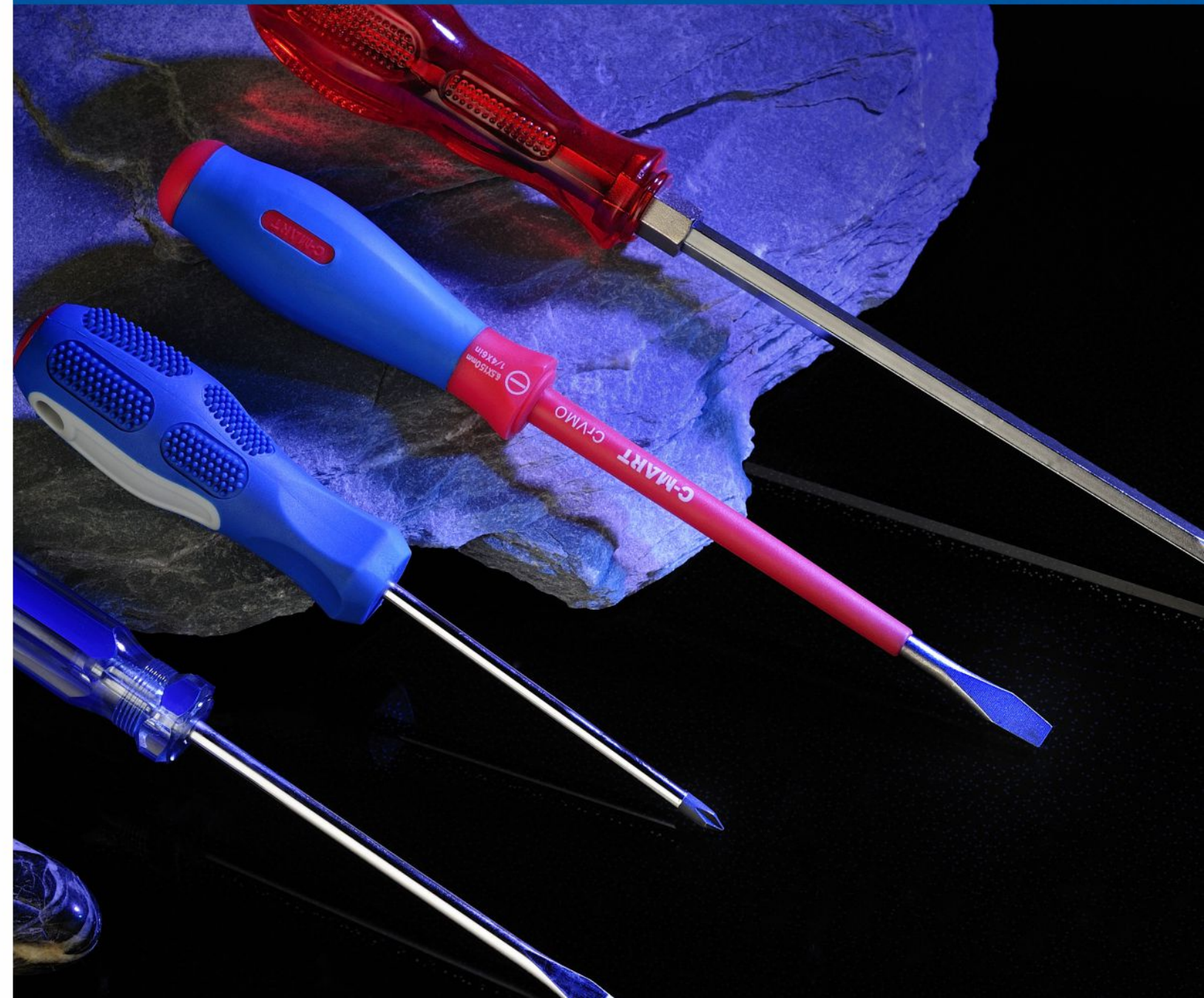



**Caulking gun**

C0001 C0002 C0003  
C0004 C0005 C0006



All metal construction

ITEM NO.	SIZE	BOX(CTN/PCS)
C0001-09	225mm/9"	8/32



All metal construction

ITEM NO.	SIZE	BOX(CTN/PCS)
C0002-09	225mm/9"	8/32



All metal construction

ITEM NO.	SIZE	BOX(CTN/PCS)
C0003-09	225mm/9"	8/32



All metal construction

ITEM NO.	SIZE	BOX(CTN/PCS)
C0004-09	225mm/9"	8/32



All metal construction

ITEM NO.	SIZE	BOX(CTN/PCS)
C0005-09	225mm/9"	8/32



Aluminum pipe

ITEM NO.	SIZE	BOX(CTN/PCS)
C0006-09	225mm/9"	6/24
C0006-15	375mm/15"	6/12

**Soldering iron**

C0016 C0171 C0017



ITEM NO.	SIZE	BOX(CTN/PCS)
C0016-30	30W	8/64
C0016-40	40W	8/64
C0016-60	60W	8/64
C0016-80	80W	8/64



ITEM NO.	SIZE	BOX(CTN/PCS)
C0171-80	80W	8/48
C0171-100	100W	8/48
C0171-150	150W	8/48
C0171-200	200W	6/24
C0171-300	300W	6/24



Two-pin plug

ITEM NO.	SIZE	BOX(CTN/PCS)
C0017-30	30W	8/80
C0017-40	40W	8/80
C0017-60	60W	8/80
C0017-80	80W	8/80
C0017-100	100W	8/80



Three-pin plug

Special treated tip, stainless steel pipe  
Heat resistant plastic handle  
A bonus stand included

**Soldering iron replacement parts**



ITEM NO.	SIZE	BOX(CTN/PCS)
C0017A-30	30W	100/-
C0017A-40	40W	100/-
C0017A-60	60W	100/-
C0017A-80	80W	100/-
C0017A-100	100W	100/-
C0016A-30	30W	2/-
C0016A-40	40W	2/-
C0016A-60	60W	2/-
C0016A-80	80W	2/-



ITEM NO.	SIZE	BOX(CTN/PCS)
C0017B-30-Z	30W	100/-
C0017B-40-Z	40W	100/-
C0017B-60-Z	60W	100/-
C0017B-80-Z	80W	100/-
C0017B-100-Z	100W	100/-
C0017B-30-W	30W	100/-
C0017B-40-W	40W	100/-
C0017B-60-W	60W	100/-
C0017B-80-W	80W	100/-
C0017B-100-W	100W	100/-
C0016B-220-30	30W	10/-
C0016B-220-40	40W	10/-
C0016B-220-60	60W	10/-
C0016B-220-80	80W	10/-

**Rosin core solder**  
C0013



ITEM NO.	SIZE	BOX(CTN/PCS)
C0013-16	-	-
C0013-250	-	-
C0013-500	-	10/40

**Desoldering pump**  
C0014



ITEM NO.	SIZE	BOX(CTN/PCS)
C0014-08	200mm/8"	24/240

**Heater core for hot air blower**  
C0018A  
C00181A



ITEM NO.	SIZE	BOX(CTN/PCS)
C0018A-1600	1600W	1/-
C0018A-2000	2000W	1/-
C00181A-1600	1600W	1/-

**Hot air blower**

C0181-1600 C0018  
C0018



Voltage: 220V  
Temperature: 50-400°C  
Air volume: Low 190-210l/min  
Function: hot / cool air  
Power input: 1600W  
Settings: 50-550°C  
High: 310-350l/min  
Adjustable temperature

ITEM NO.	SIZE	BOX(CTN/PCS)
C0181-1600	1600W	1/10



Voltage: 220-240V  
Temperature: 400/500°C  
Air flow: 550/750l/min  
Power input: 1800W  
Switch control: 2 Stage[ I / II ]  
Cable length: 2M

ITEM NO.	SIZE	BOX(CTN/PCS)
C0181-1800	1600W	1/10



Circuit Board-12000 hours of warranty  
Motor-300 hours of warranty  
Heating core-1200 hours of warranty

Hot air blower widely applied in various industries  
Powerful element provides sufficient heat for removal of paints and varnish, thawing of frozen pipes, heating shrink tubes and welding copper tube etc  
Variable temperature control allows selection of correct heat for a range of applications

ITEM NO.	SIZE	BOX(CTN/PCS)
C0018-1600	1600W	1/10
C0018-2000	2000W	1/10

**Digital display hot air blower**



2 SPEEDS controlled air volumes, allow you to match the air speed to your application.  
The LCD digital readout display allows you to monitor the temperature via a digital display when precision control is needed.  
The integration temperature control IC, accurate temperature control

ITEM NO.	SIZE	BOX(CTN/PCS)
C0018E-1600	1600W	1/10
C0018E-2000	2000W	1/10



# High quality hot air blower



Voltage: 220V  
 Temperature: 50-450°C 50-650°C  
 Air volume: Low: 200-300l/min High: 350-500l/min  
 Function: hot / cool air Adjustable temperature

## Production description

### 1.Switch

Rocker switch easy to operate

### 2.Air outlet

Turbine pipe for stronger and more directional wind

### 3.Driving force

Japan tech motor for dynamic performance and durability

### 4.Core

High quality materials and fine wormanship renders heater element ultra long service span



**C0185**



**C0185E**

### 5.Control

Autonomous programming integrated IC control circuit

### 6.Digital

Large screen digital display for easy reading (C0185E)

### 7.Temperature

One key for 4 levels of temperature control

### 8.Multinational

CE/FCC/PSE/RoHS certificated multinational plugs available



TAIWAN C-MART PRACTICAL TOOLS CO., LTD.  
 SHANGHAI C-MART TOOLS CO., LTD.

Add: No.112 Xinchuang Road, Songjiang District, Shanghai  
<http://www.cmarttools.com>



## Plastic welding torch C0183



230V- 50Hz 50-300L/min 50-550°C

ITEM NO.	SIZE	BOX(CTN/PCS)
C0183-700	700W	1/20

## Staples C0023A C0024A C0026A

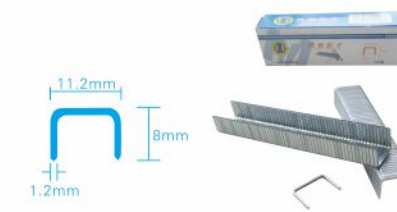

ITEM NO.	SIZE	BOX(CTN/PCS)
C0023A	11.2x8x1.2mm	1800/180000

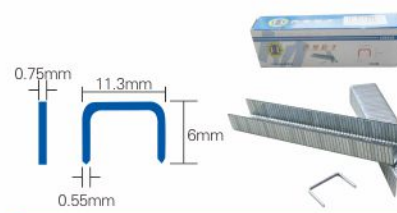

ITEM NO.	SIZE	BOX(CTN/PCS)
C0024A	11.3x6x0.55mm	1800/360000

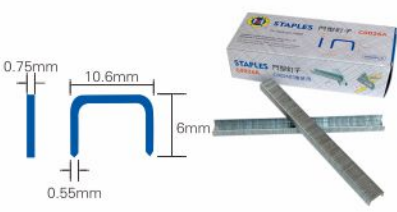

ITEM NO.	SIZE	BOX(CTN/PCS)
C0026A	10.6x6x0.55mm	1800/360000

## Hot melt glue gun | C0019 C0191 C0193 C0192 C0195



Professional quality, suitable for gluing plastic, metal, leather and wood.  
 Keep in a dry place

ITEM NO.	SIZE	BOX(CTN/PCS)
C0019-60	60W	10/40
C0019-100	100W	10/40

ITEM NO.	SIZE	BOX(CTN/PCS)
C0191-60	60W	10/60
C0193-20	20W	50/100
C0193-60	60W	24/48



ITEM NO.	SIZE	BOX(CTN/PCS)
C0192-20	20W	10/40
C0192-60	60W	12/48

## Glue sticks

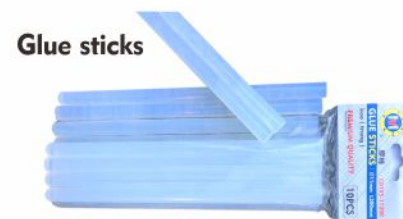

PREMIUM QUALITY



ITEM NO.	SIZE	BOX(CTN/PCS)
C0195-07150	Ø7mm L150mm	20/-
C0195-11200	Ø11mm L200mm	10/-

## Staple gun | C0023 C0024

### Heavy duty 3 way staple gun



4-14mm  
(5/32-9/16")



10-12mm  
(3/8"-1/2")



10mm-14mm  
(3/8"-9/16")

ITEM NO.	SIZE	BOX(CTN/PCS)
C0023	4-14mm	6/24

### Uni-function staple gun



4-14mm  
(5/32-9/16")

Suitable for insulation, house wrap, roofing, wiring, carpeting, upholstery.

ITEM NO.	SIZE	BOX(CTN/PCS)
C0024	4-8mm	10/40



### Euro-type stapler C0026

4-8mm  
5/32-5/16inch



Ideal for upholstery, wood working, ceiling tiles, rack & roofing.

ITEM NO.	SIZE	BOX(CTN/PCS)
C0026	4-8mm	10/40

### Heavy duty riveter



Suitable for aluminum rivets and stainless steel rivets.  
Four interchangeable nosepieces for 2.4mm 3.2mm 4.0mm and 4.8mm rivets

ITEM NO.	SIZE	BOX(CTN/PCS)
C0022	360mm/14"	1/12

### Hand riveter



Suitable for aluminum rivets and stainless steel rivets.  
Four interchangeable nosepieces for 2.4mm 3.2mm 4.0mm and 4.8mm rivets

ITEM NO.	SIZE	BOX(CTN/PCS)
C0226	238mm	10/-

### Professional nut riveter



Mandrels and compatible nosepieces  
Dismantling tool  
For nosepiece  
For main axle  
For lock pin

ITEM NO.	SIZE	BOX(CTN/PCS)
C0222	M3 M4 M5 M6 M8 M10	1/6

### Hand riveter

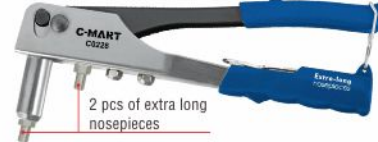

Suitable for aluminum rivets and stainless steel rivets.  
Four interchangeable nosepieces for 2.4mm 3.2mm 4.0mm and 4.8mm rivets

ITEM NO.	SIZE	BOX(CTN/PCS)
C0228	250mm/10"	10/40



2 pcs of extra long nosepieces

### Hand riveter

#### Aluminium alloy hand riveter



Suitable for aluminum rivets and stainless steel rivets.  
Four interchangeable nosepieces for 2.4mm 3.2mm 4.0mm and 4.8mm rivets

ITEM NO.	SIZE	BOX(CTN/PCS)
C0020-10	250mm/10"	6/36

#### Metal body hand riveter



Suitable for aluminum rivets and stainless steel rivets.  
Four interchangeable nosepieces for 2.4mm 3.2mm 4.0mm and 4.8mm rivets

ITEM NO.	SIZE	BOX(CTN/PCS)
C0021-10	250mm/10"	6/36

### Compact hand riveter



Suitable for aluminum rivets and stainless steel rivets.  
Four interchangeable nosepieces for 2.4mm 3.2mm 4.0mm and 4.8mm rivets

ITEM NO.	SIZE	BOX(CTN/PCS)
C0221	325mm/13"	1/18

### Hand riveter



Suitable for aluminum rivets and stainless steel rivets.  
Four interchangeable nosepieces for 2.4mm 3.2mm 4.0mm and 4.8mm rivets

ITEM NO.	SIZE	BOX(CTN/PCS)
C0225	250mm/10"	5/40

### Compact hand riveter Industrial grade



Compact size for easy carrying  
Effort-saving construction for easy operation  
Ergo-shaped double colour handle  
Suitable for aluminum rivets and stainless steel rivets.  
Four interchangeable nosepieces for 3.2mm 4.0mm and 4.8mm rivets

ITEM NO.	SIZE	BOX(CTN/PCS)
C0223	330mm	1/20

### Hand riveter



Suitable for aluminum rivets and stainless steel rivets.  
Four interchangeable nosepieces for 2.4mm 3.2mm 4.0mm and 4.8mm rivets

ITEM NO.	SIZE	BOX(CTN/PCS)
C0224	427mm	5/20

### Screwdrivers

C0030 C0032 C0034 C0031 C0033 C0341



CR-V.  
Chrome vanadium steel, magnetized tip

ITEM NO.	SIZE	BOX(CTN/PCS)	ITEM NO.	SIZE	BOX(CTN/PCS)	ITEM NO.	SIZE	BOX(CTN/PCS)
C0030-3.275-A/B	3.2x75mm	12/240	C0030-4.0150-A/B	4.0x150mm	12/240	C0030-5.0200-A/B	5.0x200mm	12/240
C0030-3.2100-A/B	3.2x100mm	12/240	C0030-4.0200-A/B	4.0x200mm	12/240	C0030-6.075-A/B	6.0x75mm	12/144
C0030-3.2150-A/B	3.2x150mm	12/240	C0030-5.075-A/B	5.0x75mm	12/240	C0030-6.0100-A/B	6.0x100mm	12/144
C0030-3.2200-A/B	3.2x200mm	12/240	C0030-5.0100-A/B	5.0x100mm	12/240	C0030-6.0125-A/B	6.0x125mm	12/144
C0030-4.075-A/B	4.0x75mm	12/240	C0030-5.0125-A/B	5.0x125mm	12/240	C0030-6.0150-A/B	6.0x150mm	12/144
C0030-4.0100-A/B	4.0x100mm	12/240	C0030-5.0150-A/B	5.0x150mm	12/240	C0030-6.0200-A/B	6.0x200mm	12/144



Cr.Mo steel  
Two years guaranteed use

ITEM NO.	SIZE	BOX(CTN/PCS)	ITEM NO.	SIZE	BOX(CTN/PCS)	ITEM NO.	SIZE	BOX(CTN/PCS)
C0032-3.250-A/B	3.2x50mm	12/480	C0032-5.0150-A/B	5.0x150mm	12/240	C0032-6.0150-A/B	6.0x150mm	12/240
C0032-3.275-A/B	3.2x75mm	12/480	C0032-5.0200-A/B	5.0x200mm	12/192	C0032-6.0200-A/B	6.0x200mm	12/192
C0032-3.2100-A/B	3.2x100mm	12/480	C0032-5.0250-A/B	5.0x250mm	12/144	C0032-6.0250-A/B	6.0x250mm	12/144
C0032-3.2150-A/B	3.2x150mm	12/480	C0032-5.0300-A/B	5.0x300mm	12/144	C0032-6.0300-A/B	6.0x300mm	12/144
C0032-3.2200-A/B	3.2x200mm	12/480	C0032-6.040-A/B	6.0x40mm	12/240	C0032-8.0150-A/B	8.0x150mm	12/120
C0032-5.075-A/B	5.0x75mm	12/240	C0032-6.075-A/B	6.0x75mm	12/240	C0032-8.0200-A/B	8.0x200mm	12/120
C0032-5.0100-A/B	5.0x100mm	12/240	C0032-6.0100-A/B	6.0x100mm	12/240			
C0032-5.0125-A/B	5.0x125mm	12/240	C0032-6.0125-A/B	6.0x125mm	12/240			



CR-V.  
Chrome vanadium steel, magnetized tip

ITEM NO.	SIZE	BOX(CTN/PCS)	ITEM NO.	SIZE	BOX(CTN/PCS)	ITEM NO.	SIZE	BOX(CTN/PCS)
C0034-3.075-A/B	3.0x75mm	12/120	C0034-5.0150-A/B	5.0x150mm	12/120	C0034-6.0150-A/B	6.0x150mm	12/120
C0034-3.0100-A/B	3.0x100mm	12/120	C0034-5.0200-A/B	5.0x200mm	12/120	C0034-6.0200-A/B	6.0x200mm	12/120
C0034-3.0125-A/B	3.0x125mm	12/120	C0034-5.0250-A/B	5.0x250mm	12/120	C0034-6.0250-A/B	6.0x250mm	12/120
C0034-3.0150-A/B	3.0x150mm	12/120	C0034-5.0300-A/B	5.0x300mm	12/120	C0034-6.0300-A/B	6.0x300mm	12/120
C0034-3.0200-A/B	3.0x200mm	12/120	C0034-6.040-A/B	6.0x40mm	12/120	C0034-8.0150-A/B	8.0x150mm	12/120
C0034-5.075-A/B	5.0x75mm	12/120	C0034-6.075-A/B	6.0x75mm	12/120	C0034-8.0200-A/B	8.0x200mm	12/120
C0034-5.0100-A/B	5.0x100mm	12/120	C0034-6.0100-A/B	6.0x100mm	12/120	C0034-8.0250-A/B	8.0x250mm	12/120
C0034-5.0125-A/B	5.0x125mm	12/120	C0034-6.0125-A/B	6.0x125mm	12/120	C0034-8.0300-A/B	8.0x300mm	12/120

### Cr.Mo steel

Two years guaranteed use

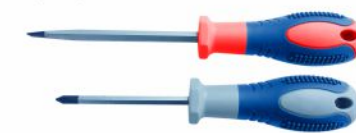

Chrome vanadium steel, magnetized tip

ITEM NO.	SIZE	BOX(CTN/PCS)	ITEM NO.	SIZE	BOX(CTN/PCS)	ITEM NO.	SIZE	BOX(CTN/PCS)
C0033-6.0100-A/B	6.0x100mm	12/144	C0033-6.0100-A	Ph2 6.0x100mm	12/120	C0341-T08	T8	12/96
C0033-6.0125-A/B	6.0x125mm	12/144	C0033-6.0150-A	Ph2 6.0x150mm	12/120	C0341-T09	T9	12/96
C0033-6.0150-A/B	6.0x150mm	12/144	C0033-8.0150-A	Ph3 8.0x150mm	12/72	C0341-T10	T10	12/96
C0033-6.0200-A/B	6.0x200mm	12/144	C0033-8.0200-A	Ph3 8.0x200mm	12/72	C0341-T15	T15	12/96
C0033-6.0250-A/B	6.0x250mm	12/144	C0033-8.0250-A	Ph3 8.0x250mm	12/72	C0341-T20	T20	12/96
			C0033-8.0300-A	Ph3 8.0x300mm	12/72	C0341-T25	T25	12/96
			C0033-6.0100-B	6.0x100mm	12/120	C0341-T27	T27	12/96
			C0033-6.0150-B	6.0x150mm	12/120	C0341-T30	T30	12/96
			C0033-8.0150-B	8.0x150mm	12/72	C0341-T40	T40	12/96
			C0033-8.0200-B	8.0x200mm	12/72			
			C0033-8.0250-B	8.0x250mm	12/72			
			C0033-8.0300-B	8.0x300mm	12/72			



Screwdrivers | C0035 C0041 C0039

**Insulation screwdrivers**  
Chrome vanadium steel, magnetized tip



ITEM NO.	SIZE	BOX(CTN/PCS)
C0035-PH075-A	Ph0x75mm	12/96
C0035-PH1100-A	Ph0x75mm	12/96
C0035-PH2200-A	Ph0x75mm	12/96
C0035-3.0100-B	Ph0x75mm	12/96
C0035-5.0125-B	Ph0x75mm	12/96
C0035-6.5150-B	Ph0x75mm	12/96

**Two way screwdrivers-slotted & philips**  
Chrome vanadium steel, magnetized tip



ITEM NO.	SIZE	BOX(CTN/PCS)
C0041-6.340	6.3x40mm/1.5"	12/120
C0041-6.3100	6.3x100mm/4"	12/120
C0041-6.3125	6.3x125mm/5"	12/120
C0041-6.3150	6.3x150mm/6"	12/120
C0041-6.3200	6.3x200mm/8"	12/120

**6 in 1 screwdriver set CR-V.**

Including:  
2pcs bits  
6.3x65mm (+)PH1x(-)3/16  
8x75mm (+)PH2x(-)1/4

※ SLOTTED: 5mm 6mm  
※ PHILLIPS: PH1 PH2  
※ NUT DRIVER: 6mm 8mm

铬钒钢整体热处理  
PH1 3MM(3/16") PH2 6MM(1/4")  
套筒头可连接及换批头  
O8mm O6mm

ITEM NO.	SIZE	BOX(CTN/PCS)
C0039	6 in 1	-

Precision screwdrivers | C0038 C0052 C0053



ITEM NO.	SIZE	BOX(CTN/PCS)
C0038-1.2	1.2mm	36/720
C0038-1.4	1.4mm	36/720
C0038-1.8	1.8mm	36/720
C0038-2.0	2.0mm	36/720
C0038-2.4	2.4mm	36/720
C0038-3.0	3.0mm	36/720



ITEM NO.	SIZE	BOX(CTN/PCS)
C0052	22-pc set	1/80



28-in 1

P2-P5
H0.7-H1.3 H0.9-H1.5 H2.0-H3.0 H2.5-H4.0
PH00-SL2.0 SL1.0-T20 PH1-SL3.0
P20-SL3.0 P21-SL4.0
T6-T10 T5-T9 T4-T8 T7-T15

ITEM NO.	SIZE	BOX(CTN/PCS)
C0053	28 in 1	1/140

**7pc precision screwdriver set**

Bits made of chrome vanadium steel  
Aluminum handle for better performance.  
Ideal tool for maintenance of smart phones,  
i-pad, cameras, watches and glasses  
One magnetizer/demagnetizer included



- 0.8mm
- PH000
- 1.2mm
- T5 T6

ITEM NO.	SIZE	BOX(CTN/PCS)
C0050	7-pc set	12/48

**31-pc precision ratchet screwdriver set**

- T4 T5 T6 T7 T8 T10 SL2.0 SL2.5 SL3.0
- PH00 PH00 PH0 PH1 PH2 SL1.0 SL1.5 P20 P21
- 3.0mm 2.5mm 3.0mm H0.7 H0.9 H1.3 H1.5 H2.0 H3.0



ITEM NO.	SIZE	BOX(CTN/PCS)
C0051	31-pc set	6/24

Screwdriver set

C0025 C0027 C0028  
C0029 C0036 C0351  
C0361 C0362

**6-pc screwdriver set**

Screwdriver bits made of carbon steel heat treated  
Chrome plated handle with swivel cap  
For electronics, watches and hobby



ITEM NO.	SIZE	BOX(CTN/PCS)
C0025	#1, #0, 1.4mm, 2.0mm 2.4mm, 3.0mm	12/108

**16-pc precision screwdriver & set**

- 14pc bits:
- PH000, Ph00, Ph0, Ph1
- T5, T6, T7, T8, T9
- 1.5 2.0 2.5 3.0 4.0mm
- 1pc bit driver
- 1pc extension bar



ITEM NO.	SIZE	BOX(CTN/PCS)
C0027	16-pc set	6/24

**16-pc Smart phone repair tool kit**

- PH00 PH000
- T4 T5
- T8 T10
- 0.8mm 2.0mm
- T6 T7
- 1.2mm 2.0mm



ITEM NO.	SIZE	BOX(CTN/PCS)
C0028	17pc-set	12/48

**8-pc impact screwdriver set**

- 36mm length S2 driver bits
- PH1 PH2 SL7 SL8
- 75mm length S2 driver bits
- PH2 SL8
- Mpact screwdriver



ITEM NO.	SIZE	BOX(CTN/PCS)
C0029	8-pc set	1/20

**6-pc screwdriver set**

Chrome vanadium steel, magnetized tip

- 3.5x75mm
- 4x100mm
- 6x150mm
- 3.5x60mm Ph0
- 5x100mm Ph1
- 6x125mm PH2



ITEM NO.	SIZE	BOX(CTN/PCS)
C0036	6-pc set	6/48

**7-pc insulation screwdriver set**

Chrome vanadium steel, magnetized tip

- 3.0x100mm Ph0 3.0x75mm
- 5.0x125mm Ph1 5.0x100mm
- 6.5x150mm Ph2 6.5x100mm



ITEM NO.	SIZE	BOX(CTN/PCS)
C0351	7-pc set	1/24

**8-pc screwdriver set**

- Ph2x38mm Ph1x75mm
- Ph2x100mm Ph2x150mm
- 6x38mm 5x75mm 6x100mm 6x150mm



ITEM NO.	SIZE	BOX(CTN/PCS)
C0361	8-pc set	1/11

**8-pc screwdriver set**

- T8x75mm T10x100mm
- T20x100mm T25x100mm
- T30x125mm T40x150mm



- T15x100mm
- T27x115mm



ITEM NO.	SIZE	BOX(CTN/PCS)
C0362	8-pc set	1/11



Electric screwdriver | C0042 C0431 C0049 C0048

HEAVY-DUTY

High efficiency taiwan servo motor  
Stepless speed regulating start switch  
Replaceable carbon brush greatly prolongs its durability  
Stepless torque adjustment

Input voltage: AC 200-240V  
Torque range: 5-60kgf.cm  
No load speed: 900rpm ± 10%  
Repeat torque accuracy: ± 0.5%  
Applicable screws: 2 - 8mm  
Noise degree: 65dB(A)  
Weight: 0.6kg



ITEM NO.	SIZE	BOX(CTN/PCS)
C0042		

SEMI-AUTO

BUY ONE , PLUS ONE

Taiwan motor  
Silver alloy switch for durability  
High speed,high torque

Cold-pressed axis for steady and stright operation  
Ergonomic dual-colour non-slip handle



ITEM NO.	INPUT VOLTAGE	OUTPUT TORQUE	NO LOAD SPEED	BITS APPLICABLE
C0431-04	DC-36V	2-15kgf.cm	1300rpm	Ø4mm
C0431-05	DC-36V	2-25kgf.cm	1400rpm	Ø5mm
C0431-06	DC-36V	3-35kgf.cm	1100rpm	Ø6mm
C0431-1/4	DC-36V	3-35kgf.cm	1100rpm	ØSS1/4mm

INDUSTRIAL LEVEL

Ergonomic handle bar,heat resistant,shock-proof and comfortable to hold,Super stable torque control even at the minimum torque position of 0.5 kgf.cm with accuracy up to ± 5%  
Our compact high quality power controller with stepless speed control allows the machine to run for a long time with no worry of over heat and without much noise  
Speed ranges from 500 rpm/min.to 1400 rpm/min.  
High-tech precision DC motor from Taiwan ensures steady and efficient operation  
Best used on toy,home appliance,furniture and other product assembly lines



ITEM NO.	INPUT VOLTAGE	OUTPUT TORQUE	NO LOAD SPEED	BITS APPLICABLE
C0049-04	DC-36V	2-15kgf.cm	900-1400rpm	Ø4mm
C0049-05	DC-36V	2-25kgf.cm	1000-1500rpm	Ø5mm
C0049-06	DC-36V	5-35kgf.cm	700-1200rpm	Ø6mm
C0049-1/4	DC-36V	5-35kgf.cm	700-1200rpm	ØSS1/4mm



ITEM NO.	SIZE	BOX(CTN/PCS)
C0048-05	Ø5mm	
C0048-06	Ø6mm	
C0048-1/4	ØS1/4mm	

Cordless screwdriver  
W0032 W0047

Input voltage: 12V  
Rated power: 30Wh  
Weight: 200g  
Battery life: 500/times  
Battery capacity: 2000mAh  
Specs.: 36x39x80(h)



ITEM NO.	SIZE	BOX(CTN/PCS)
W0032	1/4"	

MINI TYPE

The smallest screwdriver in the world with torque adjustment function  
Torque range: 0.01N.m-0.3N.m  
Charging mode: wireless and plug in selectable  
Easy to carry and store  
Unique clutch release mechanism to protect screws from damage

Torque adjustment: stepless  
Torque: 0.01-0.1(0.1-1)  
No load speed: 250  
Battery capacity: 350mAh



ITEM NO.	SIZE	BOX(CTN/PCS)
W0047	1/2"	

Patented electric screwdriver | C00043 C0044 C0045

Industrial grade



**C0043** Semi-auto electric screwdriver  
**C0044** Full-auto electric screwdriver  
**C0045** Ac-direct plug-in electric screwdriver

Taiwan motor  
Silver alloy switch for durability  
High speed, high torque  
Cold-pressed axis for steady and straight operation  
Ergonomic dual-colour non-slip handle

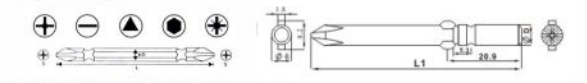

ITEM NO.	INPUT VOLTAGE	OUTPUT TORQUE	NO LOAD SPEED	BITS APPLICABLE	QTY.
C0043-04	DC-36V	2-15kgf.cm	1300rpm	Ø4mm	20PCS
C0043-05	DC-36V	2-25kgf.cm	1400rpm	Ø5mm	20PCS
C0043-06	DC-36V	3-35kgf.cm	1100rpm	Ø6mm	20PCS
C0043-1/4	DC-36V	3-35kgf.cm	1100rpm	ØSS1/4mm	20PCS
C0044-04	DC-36V	2-15kgf.cm	1300rpm	Ø4mm	20PCS
C0044-05	DC-36V	2-25kgf.cm	1400rpm	Ø5mm	20PCS
C0044-06	DC-36V	3-35kgf.cm	1100rpm	Ø6mm	20PCS
C0044-1/4	DC-36V	3-35kgf.cm	1100rpm	ØSS1/4mm	20PCS
C0045-05	AC-200-240V	2-20kgf.cm	1000rpm	Ø5mm	20PCS
C0045-06	AC-200-240V	3-28kgf.cm	900rpm	Ø6mm	20PCS
C0045-1/4	AC-200-240V	3-28kgf.cm	900rpm	ØSS1/4mm	20PCS

ITEM NO.	INPUT VOLTAGE	OUTPUT TORQUE	NO LOAD SPEED	BITS APPLICABLE	QTY.
C0043-04D	DC-36V	2-15kgf.cm	1300rpm	Ø4mm	20PCS
C0043-05D	DC-36V	2-25kgf.cm	1400rpm	Ø5mm	20PCS
C0043-06D	DC-36V	3-35kgf.cm	1100rpm	Ø6mm	20PCS
C0043-1/4D	DC-36V	3-35kgf.cm	1100rpm	ØSS1/4mm	20PCS
C0044-04D	DC-36V	2-15kgf.cm	1300rpm	Ø4mm	20PCS
C0044-05D	DC-36V	2-25kgf.cm	1400rpm	Ø5mm	20PCS
C0044-06D	DC-36V	3-35kgf.cm	1100rpm	Ø6mm	20PCS
C0044-1/4D	DC-36V	3-35kgf.cm	1100rpm	ØSS1/4mm	20PCS

Electric screwdriver component diagram

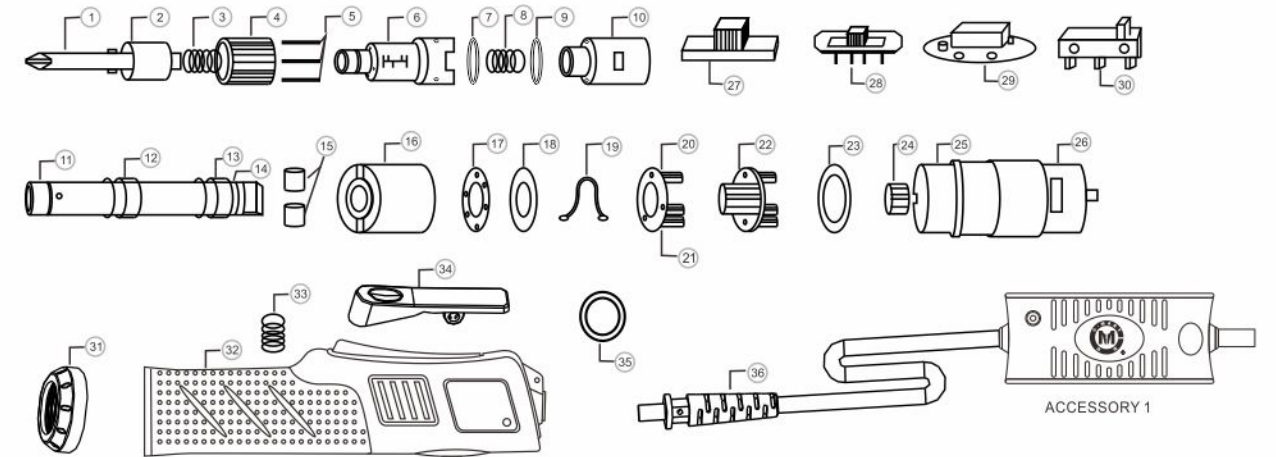

NO.	NAME	QUANTITY	NO.	NAME	QUANTITY	NO.	NAME	QUANTITY	NO.	NAME	QUANTITY	NO.	NAME	QUANTITY
1	Bit	1	9	Washer	1	17	Flat bearings	1	25	Connector bar	1	33	Press button spring	1
2	Lock sleeve	1	10	Cabinet	1	18	Bearing pedestal	1	26	Motor	1	34	Press button	1
3	Lock sleeve spring	1	11	Main axle	1	19	Circlip	1	27	Riversible switch cap	1	35	Hanging ring	1
4	Torque adjustment sleeve	1	12	Front bearing	1	20	Planet carrier	1	28	Riversible switch	1	36	Cable only	1
5	Position pins	3	13	Rear bearing	1	21	Planet gear	6	29	Circuit board	1			
6	Torque block	1	14	Circlip	1	22	Planet carrier	1	30	Start switch	1	Accessory1	Speed adjustable power station (備註: 備D系列產品配用)	1
7	Washer	1	15	Rolling bearings	2	23	Washer	1	31	Handle cap	1			
8	Torque spring	1	16	Inner gear sleeve	1	24	Motor gear	1	32	Double-color handle	1			



### Variable frequency power controller C0046



Inverter dc design saves electricity and environment friendly  
Super strong start and high anti-stall torque  
Automatic constant current control allows screwdriver to perform smoothly and prolongs its working life  
High power, long life, new style

ITEM NO.	SIZE	BOX(CTN/PCS)
C0046-80	80W	~20
C0046-160	160W	~50

### Soldering station | C0936



Grounding resistance of the welding nozzle:  $\leq 2\Omega$  ( Factory setting )  
Voltage to the ground of the welding nozzle:  $\leq 2MV$  ( Factory setting )  
Temperature error:  $\pm 3^\circ C$  ( static air: 25 $^\circ C$  45% )

Supply voltage: 220V / 50Hz / AC    Temperature range: 200 $^\circ C$ ~480 $^\circ C$   
Output voltage: AC24V / AV9V    Dimensions: W115xH90xD140  
Power: 60W    Weight: 1.3KG ( Excluding the handle )

ITEM NO.	SIZE	BOX(CTN/PCS)
C0936	60W	1/-

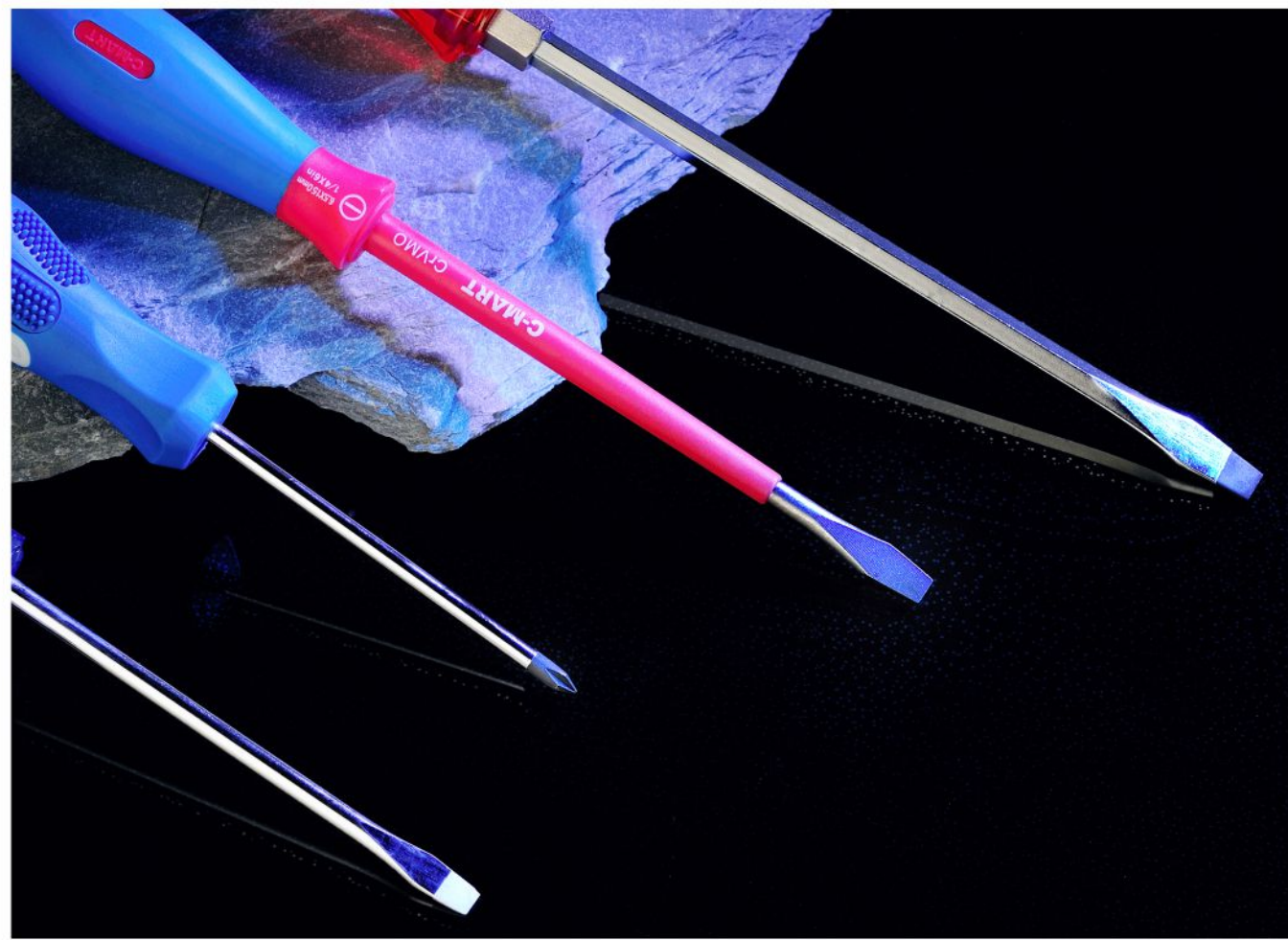

## Measuring tools

### D Series





### Measuring tape

D0001 D0002  
D0004 D0005 D0006  
D0007 D0501 D0008 D0009



ITEM NO.	SIZE	BOX(CTN/PCS)
D0001-316	MM & inch   Metric 3mx16mm	12/240
D0001-519	MM & inch   Metric 5mx19mm	12/120
D0001-525	MM & inch   Metric 5mx25mm	10/100
D0001-7.525	MM & inch   Metric 7.5mx25mm	6/60

ITEM NO.	SIZE	BOX(CTN/PCS)
D0002-212.5	MM & inch   Metric 2mx12.5mm	12/288
D0002-213	MM & inch   Metric 2mx13mm	12/288
D0002-312.5	MM & inch   Metric 3mx12.5mm	12/240
D0002-316	MM & inch   Metric 3mx16mm	12/240
D0002-3.516	MM & inch   Metric 3.5mx16mm	12/144
D0002-519	MM & inch   Metric 5mx19mm	12/120

ITEM NO.	SIZE	BOX(CTN/PCS)
D0002-5.519	MM & inch   Metric 5.5mx19mm	12/120
D0002-525	MM & inch   Metric 5mx25mm	10/100
D0002-5.525	MM & inch   Metric 5.5mx25mm	10/100
D0002-7.525	MM & inch   Metric 7.5mx25mm	6/60
D0002-825	MM & inch   Metric 8mx25mm	6/60
D0002-1025	MM & inch   Metric 10mx25mm	6/48



Rubber-wrapped case for better grip and comfort.  
Anti-rust resin coating.  
Reinforced hook with three rivets.

ITEM NO.	SIZE	BOX(CTN/PCS)
D0004-216	MM & inch   Metric 2mx16mm	12/72
D0004-316	MM & inch   Metric 2mx16mm	12/72
D0004-3.516	MM & inch   Metric 3.5mx16mm	12/72
D0004-519	MM & inch   Metric 5mx19mm	10/120
D0004-7.525	MM & inch   Metric 7.5mx25mm	12/48

### Steel measuring tape



ITEM NO.	SIZE	BOX(CTN/PCS)
D0005-519-GY	Fengshui Tape 5mx19mm	12/120
D0005-7.525-GY	Fengshui Tape 7.5mx25mm	6/60
D0005-1025-GY	Fengshui Tape 10mx25mm	6/48
D0005-519-LB	Luban Tape 5mx19mm	12/120
D0005-7.525-LB	Luban Tape 7.5mx25mm	6/60
D0005-1025-LB	Luban Tape 10mx25mm	6/48

### Chrome-plated measuring tape

Metal case chrome plated  
Carbon steel tape chrome-plated  
Both metric, metric & S.A.E. combined graduations available



ITEM NO.	SIZE	BOX(CTN/PCS)
D0006-30	30m	1/20
D0006-50	50m	1/20

### Fiber-glass measuring tape

Double colour plastic case  
High quality fibre-glass tape  
Both metric, metric & S.A.E. combined graduations available  
Tape retraction speed 3 times faster



ITEM NO.	SIZE	BOX(CTN/PCS)
D0008-30	30m	1/20
D0008-50	50m	1/20



ITEM NO.	SIZE	BOX(CTN/PCS)
D0007-316	MM & inch   Metric 3mx16mm	12/120
D0007-519	MM & inch   Metric 5mx19mm	12/120
D0007-525	MM & inch   Metric 5mx25mm	10/100
D0007-7.525	MM & inch   Metric 7.5mx25mm	12/72



Patent Case Design For Better Grip.  
Anti-rust Resin Coating.  
Reinforced Hook Pad.

ITEM NO.	SIZE	BOX(CTN/PCS)
D0501-316-LB	Luban 3mx16mm	12/240
D0501-519-LB	Luban 5mx19mm	12/120
D0501-525-LB	Luban 5mx25mm	10/100
D0501-7.525-LB	Luban 7.5mx25mm	6/60
D0501-1025-LB	Luban 10mx25mm	6/48

### Torpedo spirit level

D0011

Impact-resistant plastic with aluminum lining  
Three quality vials  
Magnetic base



ITEM NO.	SIZE	BOX(CTN/PCS)
D0011-09	225mm/9"	20/120

### Mini spirit level

D0012

Impact-resistant plastic with aluminum lining  
Two quality vials  
Magnetic base  
Compact size easy to carry



ITEM NO.	SIZE	BOX(CTN/PCS)
D0012-04	100m/4"	12/120



Double layer resin coated steel tape  
Both metric, metric & S.A.E. combined graduations available

ITEM NO.	SIZE	BOX(CTN/PCS)
D0009-10	10mm	6/60
D0009-20	20mm	6/48
D0009-30	30mm	6/36

### Aluminium spirit level

D0010 D0013 D0014



### D0010 Magnetic base

3 fixed acrylic vials with professional accuracy  
Accuracy 0.5mm/m  
Soft rubber end covers for shock absorption  
0.8mm high quality profile

ITEM NO.	SIZE	BOX(CTN/PCS)
D0010-12	300mm/12"	-/50
D0010-16	400mm/16"	-/50
D0010-20	500mm/20"	-/50
D0010-24	600mm/24"	-/50
D0010-32	800mm/32"	-/50
D0010-40	1000mm/40"	-/50
D0010-48	1200mm/48"	-/50
D0010-60	1500mm/60"	-/50
D0010-72	1800mm/72"	-/50

### D0013 Magnetic base

Thick aluminum construction insures long time steady performance  
Three quality vials for multi-purpose measuring  
Strong magnet installed  
High level of accuracy guaranteed

ITEM NO.	SIZE	BOX(CTN/PCS)
D0013-12	300mm/12"	-/50
D0013-16	400mm/16"	-/50
D0013-20	500mm/20"	-/50
D0013-24	600mm/24"	-/50
D0013-32	800mm/32"	-/30
D0013-40	1000mm/40"	-/30
D0013-48	1200mm/48"	-/20
D0013-60	1500mm/60"	-/20
D0013-72	1800mm/72"	-/20

### D0014

Thick aluminum construction insures long time steady performance  
Three quality vials for multi-purpose measuring  
High level of accuracy guaranteed

ITEM NO.	SIZE	BOX(CTN/PCS)
D0014-12	300mm/12"	-/50
D0014-16	400mm/16"	-/50
D0014-20	500mm/20"	-/50
D0014-24	600mm/24"	-/50
D0014-32	800mm/32"	-/30
D0014-40	1000mm/40"	-/30
D0014-48	1200mm/48"	-/20
D0014-60	1500mm/60"	-/20
D0014-72	1800mm/72"	-/20

### Try square

D0015 D0016 D0017

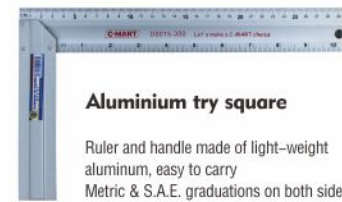

### Aluminium try square

Ruler and handle made of light-weight aluminum, easy to carry  
Metric & S.A.E. graduations on both sides

ITEM NO.	SIZE	BOX(CTN/PCS)
D0015-250	250mm	12/96
D0015-300	300mm	10/60
D0015-500	500mm	6/48

### Combination try square stainless steel

Stainless steel ruler with metric and S.A.E. markings on both sides  
Aluminum handle with level vial  
Four ways of measuring as shown below

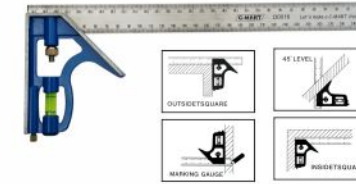

ITEM NO.	SIZE	BOX(CTN/PCS)
D0016-12	300mm/12"	12/72

### Aluminium try square

Stainless steel ruler, aluminum handle  
Adjustable angle-finder stored in handle for multi-angle measuring

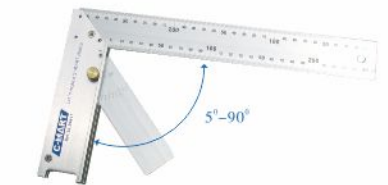

ITEM NO.	SIZE	BOX(CTN/PCS)
D0017-12	300mm/12"	6/48

### Thickness gauge

D0018



ITEM NO.	SIZE	BOX(CTN/PCS)
D0018-15	0.05mm-0.63mm	12/-
D0018-26	0.03mm-0.63mm	12/-
D0018-31	0.04mm-0.88mm	12/-

### Stainless steel ruler

D0019



Stainless steel  
Metric graduation on one side, conversion table on the other

ITEM NO.	SIZE	BOX(CTN/PCS)
D0019-150	150mm	12/1200
D0019-300	300mm	10/300
D0019-500	500mm	10/100
D0019-600	600mm	10/100
D0019-1000	1000mm	10/40

### Stainless steel protractor

D0023 D0025



ITEM NO.	SIZE	BOX(CTN/PCS)
D0023		10/100
D0025		10/100



Vernier caliper

D0020 D0201 D0021  
D0027 D0024 D0022

Vernier caliper with metric or inch scale

Made of stainless steel heat-treated  
Used for outside, inside, depth and steps measurement



ITEM NO.	SIZE	BOX(CTN/PCS)
D0020-06-GQ	Metric 0-150mm	1/50
D0020-06-GY	MM & inch 0-150mm	1/50
D0020-08-GQ	Metric 0-200mm	1/50
D0020-08-GY	MM & inch 0-200mm	1/50

Dial calipers (close frame type)

Metric/inch and only metric scale(marking) selectable.  
With a fixed scale and a sliding scale.  
With fastening screw.  
Made of high carbon steel chrome plated.



ITEM NO.	SIZE	BOX(CTN/PCS)
D0027-06	0-150mm	1/50
D0027-08	0-200mm	-

Vernier caliper

Made of carbon steel heat-treated  
Used for outside, inside, depth and steps measurement

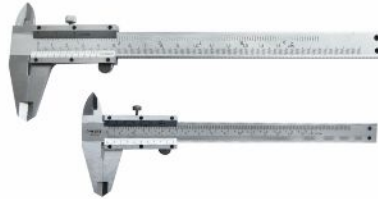

ITEM NO.	SIZE	BOX(CTN/PCS)
D0201-06	0-150mm	10/50
D0201-08	0-200mm	-

Dial calipers (close frame type)

Stainless steel ruler  
Large screen dial for easy reading  
Used for outside, inside, depth and steps measurement



ITEM NO.	SIZE	BOX(CTN/PCS)
D0024-06	0-150mm	1/50

Electronic digital caliper

Stainless steel ruler  
Zinc alloy digital display case  
Used for outside, inside, depth and steps measurement  
Metric / inch interchangeable



ITEM NO.	SIZE	BOX(CTN/PCS)
D0021-06	0-150mm	10/50
D0021-08	0-200mm	1/50

Electronic digital caliper

Stainless steel ruler  
Plastic digital display case  
Used for outside, inside, depth and steps measurement  
Metric / inch interchangeable



ITEM NO.	SIZE	BOX(CTN/PCS)
D0022-06	0-150mm	10/50
D0022-08	0-200mm	1/50

Outside micrometer  
D0026



Graduation metric 0.01mm inch 0.0001"  
Spindle lock, with zero adjusting wrench, carbide tipped

ITEM NO.	SIZE	BOX(CTN/PCS)
D0026-025	0-25mm	10/50
D0026-2550	25-50mm	10/50
D0026-5075	50-75mm	10/50

Automatic ink fountain  
D0034

Automatic retraction, quick and convenient  
Compact and light weight  
Designed to keep ink from evaporation  
Chalk line is evenly soaked with ink to ensure clear marking  
Designed to keep the chalk line from reversing



ITEM NO.	SIZE	BOX(CTN/PCS)
D0034	0-150mm	6/48

Distance measuring wheel | D0031 D0032

Digital distance measuring wheel

Max measuring range: 10000 metres or 9999.9米  
Accuracy: +/-0.5%  
Minimum reading: 0.1m  
Power supply: 1.5V (2X "AAA" batteries)  
Suitable temperature for use: -10°C~45°C

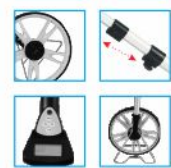

- ※ Wheel made of impact ABS covered with wear resistant rubber ring
- ※ Large LCD Digital Display
- ※ 3-section aluminum handle makes it easy to put the tool in your backpack
- ※ Dust and water proof buttons
- ※ Metric and inch selectable with memory function
- ※ Blu-ray display readable at night
- ※ Metal side stand

ITEM NO.	SIZE	BOX(CTN/PCS)
D0031		

Distance measuring wheel

Max range: 99999.9米  
Accuracy: +/-0.5%  
Minimum reading: 0.1m  
Suitable temperature: -10°C~45°C  
Diameter of the wheel: 318mm/12.5"  
Measuring unit: Meter



- ※ Wheel made of impact ABS covered with wear resistant rubber ring
- ※ Ratchet gear-driven counter moves forward to increase count and moves backward to decrease count, with reset button
- ※ Telescopic aluminum handle with ergo-shaped dual-colored grip
- ※ Retractable metal stand

ITEM NO.	SIZE	BOX(CTN/PCS)
D0032		

Brush | E0001 E0008 E0009

Knife-shaped steel wire brush

Hardened steel wires twisted and brass plated  
Ergo-shaped plastic handle



ITEM NO.	SIZE	BOX(CTN/PCS)
E0001-10	250mm/10"	12/120

Cup brush-crimped wire



ITEM NO.	SIZE	BOX(CTN/PCS)
E0008-03	75mm/3" M10x1.5	-
E0008-04	100mm/4" M14x2.0	-

Cup brush-twisted wire



ITEM NO.	SIZE	BOX(CTN/PCS)
E0009-03	75mm/3" M10x1.5	-
E0009-04	100mm/4" M14x2.0	-

Flap discs | E0005



For cleaning and polishing metal and wood

ITEM NO.	SIZE	BOX(CTN/PCS)	ITEM NO.	SIZE	BOX(CTN/PCS)
E0005-40	100x16mm/#40	10/240	E0005-220	100x16mm/#220	10/240
E0005-60	100x16mm/#60	10/240	E0005-240	100x16mm/#240	10/240
E0005-80	100x16mm/#80	10/240	E0005-280	100x16mm/#280	10/240
E0005-100	100x16mm/#100	10/240	E0005-320	100x16mm/#320	10/240
E0005-120	100x16mm/#120	10/240	E0005-360	100x16mm/#360	10/240
E0005-150	100x16mm/#150	10/240	E0005-400	100x16mm/#400	10/240
E0005-180	100x16mm/#180	10/240			

5-pc high carbon steel file set | E0013



1-8" half-round file 1-8" round file  
1-8" triangle file 1-8" flat file second cut  
1-8" flat file bastard

ITEM NO.	SIZE	BOX(CTN/PCS)
E0013	200mm/8"	5/20

5-pc needle file set  
E0015



High carbon steel heat treated

ITEM NO.	SIZE	BOX(CTN/PCS)
E0015-5180	5x180mm	10/100

High carbon steel file | E0014

High carbon steel heat treated

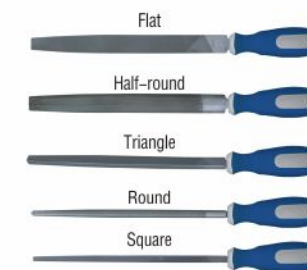

ITEM NO.	SIZE	BOX(CTN/PCS)	ITEM NO.	SIZE	BOX(CTN/PCS)
E0014-W-06	Round 150mm/6"	12/72	E0014-BW-12	Half-round 300mm/12"	12/36
E0014-W-08	Round 200mm/8"	12/72	E0014-BW-14	Half-round 350mm/14"	12/36
E0014-W-10	Round 250mm/10"	6/36	E0014-P-06	Flat 150mm/6"	12/72
E0014-W-12	Round 300mm/12"	6/36	E0014-P-08	Flat 200mm/8"	12/72
E0014-W-14	Round 350mm/14"	6/36	E0014-P-10	Flat 250mm/10"	12/36
E0014-SJ-06	Triangle 150mm/6"	12/72	E0014-P-12	Flat 300mm/12"	12/36
E0014-SJ-08	Triangle 200mm/8"	12/72	E0014-P-14	Flat 350mm/14"	12/36
E0014-SJ-10	Triangle 250mm/10"	12/36	E0014-F-06	Square 150mm/6"	12/72
E0014-SJ-12	Triangle 300mm/12"	12/36	E0014-F-08	Square 200mm/8"	12/72
E0014-SJ-14	Triangle 350mm/14"	12/36	E0014-F-10	Square 250mm/10"	12/36
E0014-BW-06	Half-round 150mm/6"	12/72	E0014-F-12	Square 300mm/12"	12/36
E0014-BW-08	Half-round 200mm/8"	12/72	E0014-F-14	Square 350mm/14"	12/36
E0014-BW-10	Half-round 250mm/10"	12/36			

10-pc needle file set  
E0016



High carbon steel heat treated

ITEM NO.	SIZE	BOX(CTN/PCS)
E0016-5180	5x180mm	12/120
E0016-3140	3x140mm	12/120
E0016-4160	4x160mm	12/120



**Grinding wheel-for metal** | E0003



For cleaning and polishing metal

ITEM NO.	SIZE	BOX/CTN/PCS
E0003	100mm/4"	20/200

**Dry grinding abrasive paper** | E0031



ITEM NO.	SIZE	BOX/CTN/PCS
E0031	40#-800#	-/1000

**Abrasive paper**  
E0032



ITEM NO.	SIZE	BOX/CTN/PCS
D0032	40#-800#	-/1000

**Combination sharpening stone** | E0026



Aluminum oxide  
Grit one side: 100#  
Grit the other side: 240#

ITEM NO.	SIZE	BOX/CTN/PCS
E0026-06	150mm/6"	1/50
E0026-08	200mm/8"	1/30

**Brick-laying trowels**  
E0027



High carbon steel polished and heat treated  
Double colour plastic handle

ITEM NO.	SIZE	BOX/CTN/PCS
D0027-05	125mm/5"	1/120
D0027-06	150mm/6"	1/120
D0027-07	175mm/7"	1/120
D0027-08	200mm/8"	1/120
D0027-09	225mm/9"	-

**Plastering trowels**  
E0028



High carbon steel polished and heat treated  
Double colour plastic handle

ITEM NO.	SIZE	BOX/CTN/PCS
D0028	200mm/8"	1/60



**Striking & struck tools**

**G Series**





### Hammer

G0001 G0002 G0002A  
G0003 G0004 G0005  
G0006 G0010 G0011 G0009 G0007

**Rubber mallet**  
Quality rubber head with hard wood handle



ITEM NO.	SIZE	BOX(CTN/PCS)
G0001-08	8 oz	12/60
G0001-12	12 oz	12/48
G0001-16	16 oz	12/36
G0001-24	24 oz	12/24

**Two-way mallet**  
Striking caps replaceable if worn-out  
Hard wood handle



ITEM NO.	SIZE	BOX(CTN/PCS)
G0002-30	30mm	12/60
G0002-40	40mm	12/36

**Mallet head replacements**



ITEM NO.	SIZE	BOX(CTN/PCS)
G0002A-30-Y	Yellow 30mm	-/60
G0002A-40-Y	Yellow 40mm	-/36
G0002A-30-B	Black 30mm	-/60
G0002A-40-B	Black 40mm	-/36

**Dead blow rubber mallet**



ITEM NO.	SIZE	BOX(CTN/PCS)
G0003-1	1 LB	6/36
G0003-1.5	1.5LB	6/24
G0003-2	2 LB	6/18
G0003-3	3 LB	6/12
G0003-4	4 LB	6/12
G0003-5	5 LB	-/6
G0003-6	6 LB	-/6

**Claw hammer, wood handle**  
Drop forged high carbon steel heat treated and tempered  
Hard wood handle with plastic end cap



ITEM NO.	SIZE	BOX(CTN/PCS)
G0004	16 oz	6/24

**Claw hammer, steel pipe handle with rubber grip**  
Drop forged high carbon steel heat treated and tempered  
Steel pipe handle with plastic grip



ITEM NO.	SIZE	BOX(CTN/PCS)
G0005-08	8 oz	6/48
G0005-12	12 oz	6/36
G0005-16	16 oz	6/24

**Sledge hammer, fibre-glass handle**  
Drop forged high carbon steel heat treated and tempered  
Double-colour fibre-glass handle



ITEM NO.	SIZE	BOX(CTN/PCS)
G0006-03	3 LB	6/12
G0006-04	4 LB	6/12
G0006-06	6 LB	-/6
G0006-08	8 LB	-/6
G0006-10	10 LB	-/4
G0006-12	12 LB	-/2
G0006-16	16 LB	1/2
G0006-18	18 LB	1/2

**Ball pein hammers**  
Drop forged high carbon steel heat treated and tempered  
Hard wood handle with plastic end cap



ITEM NO.	SIZE	BOX(CTN/PCS)
G0010-0.5	0.5 oz	6/72
G0010-1	1 oz	6/48
G0010-1.5	1.5 oz	6/36
G0010-2	2 oz	6/24

**Machinist's hammer**  
Drop forged high carbon steel heat treated and tempered  
Hard wood handle



ITEM NO.	SIZE	BOX(CTN/PCS)
G0011-200	200g	6/72
G0011-300	300g	6/48
G0011-500	500g	6/36
G0011-800	800g	6/24
G0011-1500	1500g	6/12

**Dead blow/brass hammer**



ITEM NO.	SIZE	BOX(CTN/PCS)
G0009	24 oz	6/24

**Claw hammer, fibre-glass handle**  
Drop forged high carbon steel heat treated and tempered  
Fibre-glass handle with soft rubber grip



ITEM NO.	SIZE	BOX(CTN/PCS)
G0007-08	8 oz	6/36
G0007-12	12 oz	6/36
G0007-16	16 oz	6/36

### Safety goggles

H0001  
H0002  
H0201



H0001 Welding goggles  
H0002 Safety goggles  
H0201 Safety goggles

ITEM NO.	SIZE	BOX(CTN/PCS)
H0001		20/80
H0002		12/240
H0201		-/200

### Welding gloves | H0005 H0006

**H0005**  
Leather working gloves



ITEM NO.	SIZE	BOX(CTN/PCS)
H0005		-/72
H0006		-/60

**H0006**  
Double layer  
heatproof welding gloves



### Led flashlight

H0003 H0004 H0015  
H0016 H0017 H0018



One aa battery included

ITEM NO.	SIZE	BOX(CTN/PCS)
H0003	One aa battery included	10/100



Two aa battery included

ITEM NO.	SIZE	BOX(CTN/PCS)
H0004	Two aa battery included	10/100



Li-ion Sac USB

ITEM NO.	SIZE	BOX(CTN/PCS)
H0015	Li-ion	-



Alkaline AAA Pin

向內合閉近光  
近光  
向外拉開遠光  
遠光

ITEM NO.	SIZE	BOX(CTN/PCS)
H0016	Alkaline	-



Li-ion Sac USB

向內合閉近光  
近光  
向外拉開遠光  
遠光

ITEM NO.	SIZE	BOX(CTN/PCS)
H0017	Li-ion	-



Li-ion Sac USB

向內合閉近光  
近光  
向外拉開遠光  
遠光

ITEM NO.	SIZE	BOX(CTN/PCS)
H0018	Li-ion	-

### Wear proof shim | L0071



ITEM NO.	SIZE	BOX(CTN/PCS)	ITEM NO.	SIZE	BOX(CTN/PCS)
L0071-03-45	45x3mm	-	L0071-03-80	80x3mm	-
L0071-03-50	50x3mm	-	L0071-03-90	90x3mm	-
L0071-03-60	60x3mm	-	L0071-03-100	100x3mm	-
L0071-03-65	65x3mm	-	L0071-03-110	110x3mm	-
L0071-03-70	70x3mm	-			



**Welding helmet**

**H0009 H0010 H0010B**  
**H0012 H0013**

**Arc welding helmet**

Double-layer lenses  
Strap size adjustable  
To be used together with safety helmet  
Safety helmet to be bought separately



ITEM NO.	SIZE	BOX(CTN/PCS)
H0009		-/25

**Arc welding helmet**

Double-layer lenses  
Strap size adjustable



ITEM NO.	SIZE	BOX(CTN/PCS)
H0010		-/25

**Arc welding helmet**

Double-layer lenses  
Strap size adjustable



ITEM NO.	SIZE	BOX(CTN/PCS)
H0010B		-/25

**Auto-darkening welding helmet**

- ※ Lithium Battery With Solar-assist
- ※ Features Auto-off Circuitry Within 15-20min
- ※ Grinding Function
- ※ Two Independent Arc Sensors
- ※ Lens Switching Time Speed 1/20000 S.
- ※ Ideal For Mma, Mig/mag, Tig Rating(10amps)
- ※ Variable Shade Din9-13
- ※ Lightweight Well-balanced Design Fully Adjustable
- Headgear Provides Comfort And Reduces Fatigue
- ※ Includes Replaceable Cover Lenses



MMA TIG MIG

ITEM NO.	SIZE	BOX(CTN/PCS)
H0012		-/1

**Auto-darkening welding helmet**

- ※ Lithium Battery With Solar-assist
- ※ Features Auto-off Circuitry Within 15-20min
- ※ Grinding Function
- ※ Two Independent Arc Sensors
- ※ Lens Switching Time Speed 1/20000 S.
- ※ Ideal For Mma, Mig/mag, Tig Rating(10amps)
- ※ Variable Shade Din9-13
- ※ Lightweight Well-balanced Design Fully Adjustable
- Headgear Provides Comfort And Reduces Fatigue
- ※ Includes Replaceable Cover Lenses



MMA TIG MIG

ITEM NO.	SIZE	BOX(CTN/PCS)
H0013		-/1

**Digital multimeter**

**L0016 L0017 L0015**

Automatic polarity indication  
Data-hold mode  
Relative value mode  
Overload protection  
Low battery indication



FEATURES  
3 1/2 digits LCD, max. reading 1999  
Overload protection  
Low battery indication  
Audible continuity



ITEM NO.	SIZE	BOX(CTN/PCS)
L0016		1/20

ITEM NO.	SIZE	BOX(CTN/PCS)
L0017		1/20

ITEM NO.	SIZE	BOX(CTN/PCS)
L0015		1/80

**Laser level**

**L0063 L0064**  
**L0641 D0028 D0028B**

**Five LED blue rays**

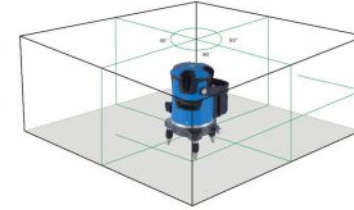

1. 4V1H1P four vertical lines, one horizontal line and one lower opposite point
2. Accuracy: ± 1mm/5m
3. Working radius: 10m

1. Osram LED lighting source from Germany
2. Wave length: 520nm
3. Self leveling mechanism valued at: ± 3°
4. Lithium battery powered to ensure up to 8 hours of working time
5. Cast iron swivel tripod base
6. Impact resistant and dust proof.
7. Working temperature: -10C° ~ +45C°



ITEM NO.	SIZE	BOX(CTN/PCS)
L0063	5 LINE	1/8



**12 LINE**

1. Type of laser line: 3x360°
2. Self leveling mechanism valued at: ± 3°
3. Accuracy ± 1mm/5m
4. Slope locking mode: available
5. Working temperature -10° ~ +45°

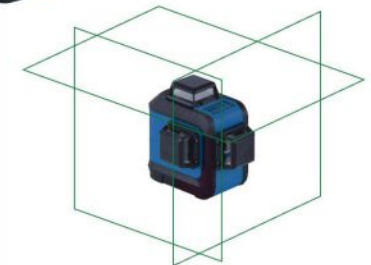

ITEM NO.	SIZE	BOX(CTN/PCS)
L0064	12 LINE	1/6

**12 LINE**

1. Type of laser line: 3x360°
2. Self leveling mechanism valued at: ± 3°
3. Accuracy ± 1mm/5m
4. Slope locking mode: available
5. Working temperature -10° ~ +45°



ITEM NO.	SIZE	BOX(CTN/PCS)
L0641	5 LINE	-

**D0028 Laser measure**



5-meter steel tape plus 30 meter laser measure.  
USB charged full for a week long use

ITEM NO.	SIZE	BOX(CTN/PCS)
D0028	5m+30m	1/60
D0028B	40m+5m	1/60

**D0028B Laser tape measure**



5M measuring tape with 40-meter infrared laser distance measurement  
Li-ion battery, USB charger  
Multi functions: distance, volume, area and Pythagorean calculation  
Multiple buttons for easy operation

**Digital voltage tester**

**L0034 L0035 L0036**



ITEM NO.	SIZE	BOX(CTN/PCS)
L0034	135mm	48/480

ITEM NO.	SIZE	BOX(CTN/PCS)
L0035	135mm	16/128

ITEM NO.	SIZE	BOX(CTN/PCS)
L0036	145mm	24/480



Digital voltage tester | L0034 L0035 L0036



ITEM NO.	SIZE	BOX(CTN/PCS)
L0037	190mm	24/480



ITEM NO.	SIZE	BOX(CTN/PCS)
L0039	145mm	60/480



ITEM NO.	SIZE	BOX(CTN/PCS)
L0033	135mm	12/240

3 way screwdriver tester | L0038



ITEM NO.	SIZE	BOX(CTN/PCS)
L0038	Ph1x4mm	-/120

Magnetizer/ Demagnetizer | L0008



ITEM NO.	SIZE	BOX(CTN/PCS)
L0008		25/100

Automatic tie wire twister | L0070



6 MONTHS OF QUARANTEED USE

ITEM NO.	SIZE	BOX(CTN/PCS)
L0070	-	-

High pressure foot pump | L0001 L0002

Single-tube high pressure pump, foot pedaled with gauge For inflating bicycle tyres, motorbike tyres, car tyres, inflatable toys and sports gears



ITEM NO.	SIZE	BOX(CTN/PCS)
L0001	55x120	-/20

Twin-tube high pressure pump, foot pedaled with gauge For inflating bicycle tyres, motorbike tyres, inflatable toys and sport gears



ITEM NO.	SIZE	BOX(CTN/PCS)
L0002	55x120	-/10

Mini pump with gauge | L0009

Presta/schrader valves compatible Inflates to maximum 120 psi/8 bar Includes 3 inflator needles Built-in pressure gauge Compact size for easy carry and storage



ITEM NO.	SIZE	BOX(CTN/PCS)
L0009	-	1/20



Hand pump | L0003 L0004 L0005-32 L0005-38 L0006

Hand pump

Additional cylinder for increased pressure making pumping easier and faster For inflating bicycle tyres, motorbike tyres, inflatabletoys and sports gears



ITEM NO.	SIZE	BOX(CTN/PCS)
L0003	32x500	-/10

Stealth pump with gauge

Featuring New insta-fit pump head, for presta and schrader valves Presta/schrader valves compatible Inflates to maximum 120 psi/8 bar Includes 3 inflator needles Built-in pressure gauge Wide stable base



ITEM NO.	SIZE	BOX(CTN/PCS)
L0004	32x530	-/10



ITEM NO.	SIZE	BOX(CTN/PCS)
L0005-32	32x530mm	-/10



ITEM NO.	SIZE	BOX(CTN/PCS)
L0005-38	38x530mm	-/10

Hand pump with gauge

The twin barrel hand pump is installed with a high air Pressure cylinder and piston resulting in light and easy operation.



ITEM NO.	SIZE	BOX(CTN/PCS)
L0001	32x500	-/10

High pressure hand pump

The twin barrel hand pump is installed with a high air Pressure cylinder and piston resulting in light and easy operation.



ITEM NO.	SIZE	BOX(CTN/PCS)
L0002	32x500	-/10

Stealth pump with gauge

Presta/schrader valves compatible Inflates to maximum 120 psi/8 bar Includes 3 inflator needles Built-in pressure gauge Wide stable base



ITEM NO.	SIZE	BOX(CTN/PCS)
L0006	32x685	-/10

Plastic oil pump | L0020 L0021 L0022



ITEM NO.	SIZE	BOX(CTN/PCS)
L0020	530mm	10/120



ITEM NO.	SIZE	BOX(CTN/PCS)
L0021	610mm	10/60



ITEM NO.	SIZE	BOX(CTN/PCS)
L0022	1210mm	-/24



**Pump oiler** | L0024 L0241 L0019



Steel hose Flexible hose

ITEM NO.	SIZE	BOX(CTN/PCS)
L0024-250F	Flexible 250ml	10/120
L0024-250M	Steel hose 250ml	10/120
L0024-400F	Flexible 400ml	10/120
L0024-400M	Steel hose 400ml	10/120



**Hand operated pump**

Type: Hand crank  
 Weight: 2.16kg  
 Length: 1.36m  
 Pumping distance: 6m  
 Liquid flow capacity: 50L/min  
 Liquid type: Oil, Light spirits, Heavy oil

ITEM NO.	SIZE	BOX(CTN/PCS)
L0019-25	28L/min	1/6
L0019-38	50L/min	1/6

**Grease gun** | L0025 L0026 L0027  
 L0028 L0029 L0032 L0030 L0031 L0041

**Auto air-venting grease gun**



ITEM NO.	SIZE	BOX(CTN/PCS)
L0025	600cc	1/12

**Heavy duty grease gun**



ITEM NO.	SIZE	BOX(CTN/PCS)
L0026	600cc	1/12

**Professional lever action grease gun**



ITEM NO.	SIZE	BOX(CTN/PCS)
L0027	600cc	1/10

Twin pistons

**Grease gun**



ITEM NO.	SIZE	BOX(CTN/PCS)
L0028	450cc	1/12

**Grease gun**



ITEM NO.	SIZE	BOX(CTN/PCS)
L0029	600cc	1/10

**Grease gun accessories(coupler)**  
 L0032



**Grease gun soft hose**  
 L0030



**Grease gun metal hose**  
 L0031



ITEM NO.	SIZE	BOX(CTN/PCS)
L0032		
L0030-12	300mm/12"	
L0030-18	450mm/18"	
L0031	175mm/7"	

**Wrecking bar** | L0041

ITEM NO.	SIZE	BOX(CTN/PCS)
L0041-18	450mm/18"	5/20
L0041-24	600mm/24"	5/10
L0041-30	750mm/30"	5/10
L0041-36	900mm/36"	4/8
L0041-48	1200mm/48"	3/6
L0041-60	1500mm/60"	3/6



**Tool box** | L0042 L0043 L0044  
 L0045-14 L0046-17 L0461-19

**Tool box with trays**



ITEM NO.	A(mm)	B(mm)	C(mm)	BOX(CTN/PCS)
L0042-17	430	180	190	1/2
L0042-20	510	218	225	1/2

**Hand-away tool box with trays**



ITEM NO.	A(mm)	B(mm)	C(mm)	BOX(CTN/PCS)
L0043-18	465	200	195	1/2
L0043-20	495	200	235	1/2



ITEM NO.	SIZE	BOX(CTN/PCS)
L0044-360	360mm/14.5"	1/12
L0044-420	420mm/17"	1/12

**Tool trolley** | L0053 L0053A  
 L0054 L0055 L0056

**Three layer tools trolley**



ITEM NO.	A(mm)	B(mm)	C(mm)	C1(mm)	BOX(CTN/PCS)
L0053	719	365	663	780	1/2

**Three layer tools trolley**  
 Promotional items



ITEM NO.	A(mm)	B(mm)	C(mm)	C1(mm)	BOX(CTN/PCS)
L0053A	719	365	663	780	-/1

**Three layer tool trolley with drawer**



ITEM NO.	A(mm)	B(mm)	C(mm)	C1(mm)	BOX(CTN/PCS)
L0054	737	383	668	785	-/1

**Five layer caster cabinet**



ITEM NO.	A(mm)	B(mm)	C(mm)	C1(mm)	BOX(CTN/PCS)
L0055	724	470	867	1032	-/1

**Seven layer caster cabinet**



ITEM NO.	A(mm)	B(mm)	C(mm)	C1(mm)	BOX(CTN/PCS)
L0056	724	470	867	1032	-/1



**Five layer caster cabinet with side cabin | L0057**



Max.loading capacity:240kgs

ITEM NO.	A(mm)	B(mm)	C(mm)	C1(mm)	BOX(CTN/PCS)
L0057	1035	458	897	1052	-/1

**Suction plate L0072**



L0072-01

L0072-02



L0072-03

ITEM NO.	SIZE	BOX(CTN/PCS)
L0072-01		1/30
L0072-02		1/20
L0072-03		1/12

**Cordless drill pouch**



ITEM NO.	SIZE	BOX(CTN/PCS)
L0062		-/100

**Tool pouch**



ITEM NO.	SIZE	BOX(CTN/PCS)
L0052		-/100

**Tool bag**

L0047 L0471  
L0048 L0472



ITEM NO.	SIZE	BOX(CTN/PCS)
L0047	320mm/13"	-/20



ITEM NO.	SIZE	BOX(CTN/PCS)
L0471	350mm/14"	1/25



ITEM NO.	SIZE	BOX(CTN/PCS)
L0048	385mm/15"	1/25



ITEM NO.	SIZE	BOX(CTN/PCS)
L0472-13	325mm/13"	1/-
L0472-15	375mm/15"	1/-
L0472-17	425mm/17"	1/-
L0472-19	475mm/19"	1/-

**Waist pouch**

L0049 L0050  
L0062 L0052 L0050 L0061

**Make-your-own wrench set**

You can select wrenches you need and arrange them in set



ITEM NO.	SIZE	BOX(CTN/PCS)
L0049-08	8-pc set	
L0049-10	10-pc set	
L0049-12	12-pc set	



ITEM NO.	SIZE	BOX(CTN/PCS)
L0050-01	Single	
L0050-02	Two-pc	
L0050-03	Three-pc	

**Waist pouch L0050-05**



**Waist pouch belt L0061**



ITEM NO.	SIZE	BOX(CTN/PCS)
L0050-05	5-pc set	
L0061		



**Gardening tools**

**A Series**





### Tree pruners | A0681

Three-section telescopic aluminum handle  
String-controlled cutter for pruning work at out-of-reach places  
Cutter and saw made of high carbon steel heat treated



PRUNING



REMOVABLE SAW

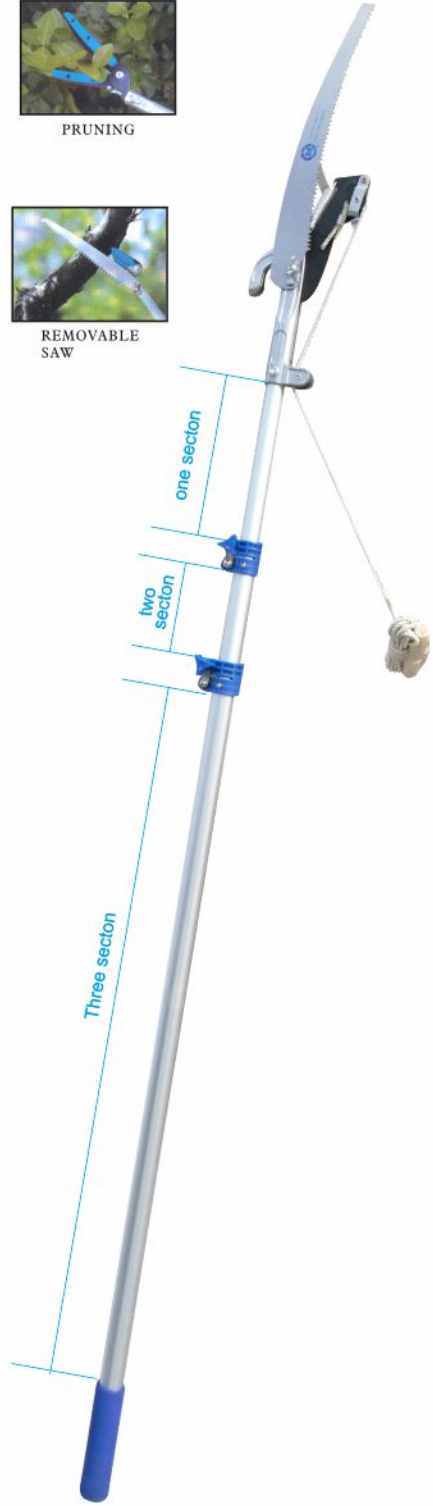

ITEM NO.	SIZE	BOX(CTN/PCS)
A0681-3	3M	-/12
A0681-5	5M	-/12

### Pruning shears | A0045 A0046 A0047 A0050 A0051 A0052 A0471

#### Pruning shears

Press-to-open auto lock  
Vinyle-dipped aluminum handle  
Special-treated Sk5 blade insures long time performance  
Cutting capacity: fresh wood dia.20mm, dry wood dia.12mm

SK5



ITEM NO.	SIZE	BOX(CTN/PCS)
A0045-08	200mm/8"	12/72

#### Multi-function shears aluminium handle

Stainless steel blades hardened  
Aluminum handle vinyle-dipped  
For bonsai, kitchen, leather, hobby and fruit & vegetable harvesting

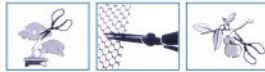

ITEM NO.	SIZE	BOX(CTN/PCS)
A0047-08	200mm/8"	6/48
A0047-09	225mm/9"	6/48

#### Pruning shears

Stainless steel blades heat treated  
Extended steel handle with ergo-shaped plastic sleeves  
Cutting capacity: fresh tree branches 16mm and less in diameter; dry branches 10mm and less.



ITEM NO.	SIZE	BOX(CTN/PCS)
A0051	185mm/7"	12/96

#### Multi-purpose scissors

Materials: stainless steel blades plastic handle  
Blade hardness: hrc54-56°  
Most suitable for the following applications



ITEM NO.	SIZE	BOX(CTN/PCS)
A0471	200mm/8"	12/96

#### Pruning shears (aluminium handle)

Ratchet construction allows easy operation for heavy-duty pruning work  
Rubber grip aluminum handle  
Special-treated Sk5 blade insures long time performance  
Cutting capacity: fresh wood dia.25mm, dry wood dia.18mm



ITEM NO.	SIZE	BOX(CTN/PCS)
A0046-08	200mm/8"	6/48

#### Pruning shears (plastic handle)

Rubber-wrapped plastic handle  
Stainless steel blades hardened  
Cutting capacity: fresh wood dia.12mm, dry wood dia.8mm



ITEM NO.	SIZE	BOX(CTN/PCS)
A0050-08	200mm/8"	12/96

#### Multi-function shears GERMAN TYPE

Sk5 steel blade, strong chrome-plated steel handle  
Blade hardness: hrc58-60°  
Most suitable for cutting herbal medicine, rattan, wiring duct and branches  
Warning: protect your hands-wear gloves



ITEM NO.	SIZE	BOX(CTN/PCS)
A0052-08	200mm/8"	12/72



ITEM NO.	SIZE	BOX(CTN/PCS)
A0471	200mm/8"	12/96

### Pruning shears | A0053 A0054 A0541 A0542 A0543 A0058 A0059 A0544 A0056 A0511 A0055

#### Pruning shears zinc alloy handle aluminum handle

High carbon steel heat treated  
Zinc alloy handle and aluminum handle available  
Cutting capacity: fresh wood dia.15mm, dry wood dia.10mm



ITEM NO.	SIZE	BOX(CTN/PCS)
A0053-07	175mm/7"	12/72
A0053-08	200mm/8"	12/72
A0053-09	225mm/9"	12/72

#### Pruning shears

Stainless steel blades hardened  
Zinc alloy handle and aluminum handle available  
For home, hobby, industry and garden use  
Cutting capacity: fresh wood dia.10mm, dry wood dia.6mm



ITEM NO.	SIZE	BOX(CTN/PCS)
A0541-07	175mm/7"	12/96
A0541-08	200mm/8"	12/72

#### Pruning secateurs

Blades made from Japan SK5 steel with metal handle vinyl dipped for comfort  
Blade hardness:hrc:58-60°  
Cutting capacity: fresh tree branches 18mm and less in diameter; dry twigs 12mm and less.  
An ideal tool for fruit farmers for long time pruning work.



ITEM NO.	SIZE	BOX(CTN/PCS)
A0058	200mm/8"	12/72

#### SK5

#### Pruning shears (zinc alloy handle)

Fish-skin zinc alloy handle for firm grip  
Special-treated Sk5 blade insures long time performance  
Cutting capacity: fresh wood dia.20mm, dry wood dia.12mm



ITEM NO.	SIZE	BOX(CTN/PCS)
A0056-07	175mm/7"	12/96
A0056-08	200mm/8"	12/72
A0056-0708	175mm/200mm	12/72

#### Multi-purpose scissors

Stainless steel blades hardened  
Double-color plastic handle  
For home, hobby, industry and garden use  
Cutting capacity: fresh wood dia.8mm, dry wood dia.4mm



ITEM NO.	SIZE	BOX(CTN/PCS)
A0054-08	200mm/8"	12/96



#### Thinning shears

Blades made from Japan SK5 steel with metal handle vinyl dipped for comfort  
Blade hardness:hrc:58-60.  
Cutting capacity: fresh tree branches 8mm and less in diameter; dry twigs 4mm and less.  
Best used for thinning and picking fruits or vegetables



ITEM NO.	SIZE	BOX(CTN/PCS)
A0542-07	175mm/7"	12/96

#### Pruning shears

Materials:stainless steel blades; metal handle with soft grip.  
Blade hardness:hrc:48-51.  
Cutting capacity: fresh tree branches 8mm and less in diameter; dry branches 4mm and less.



ITEM NO.	SIZE	BOX(CTN/PCS)
A0543	175mm/7"	12/96

#### Multi-function scissors

Stainless steel blades heat treated Sand-blast finish  
Double-colour plastic handle  
Used for cutting branches, vegetables, wires and thin metal sheet



ITEM NO.	SIZE	BOX(CTN/PCS)
A0059-07	175mm/7"	12/72
A0059-08	200mm/8"	12/72

#### Pruning shears

Stainless steel blades heat treated  
Spring-loaded plastic handle with lock for easy operation  
Cutting capacity: fresh tree branches 6mm and less in diameter;dry branches 3mm and less.  
Best used for trimming,thinning and light duty pruning



ITEM NO.	SIZE	BOX(CTN/PCS)
A0544	165mm/7"	12/96

#### SK5

#### Pruning shears (metal handle)

Vinyle-dipped metal handle  
Special-treated Sk5 blade insures long time performance  
Cutting capacity: fresh wood dia.18mm, dry wood dia.12mm



ITEM NO.	SIZE	BOX(CTN/PCS)
A0511-08	200mm/8"	12/72

#### SK5

#### Pruning shears (metal handle)

Vinyle-dipped metal handle  
Special-treated Sk5 blade insures long time performance  
Cutting capacity: fresh wood dia.20mm, dry wood dia.12mm



ITEM NO.	SIZE	BOX(CTN/PCS)
A0055-08	200mm/8"	12/72



### Hedge shears

- A0061 A0062 A0063
- A0064 A0066 A0067
- A0268 A0368 A0682

#### Hedge shears



ITEM NO.	SIZE	BOX(CTN/PCS)
A0061	275mm/11"	-/12

#### Hedge shears

Carbon steel heat-treated, steel pipe handle with plastic grip  
Blade length: 275mm/11"  
Overall length: 560mm



ITEM NO.	SIZE	BOX(CTN/PCS)
A0062	275mm/11"	-/12

#### Hedge shears

Stainless steel heat-treated, aluminum forged handle with plastic grip  
Blade length: 225mm/9"  
Overall length: 500mm



ITEM NO.	SIZE	BOX(CTN/PCS)
A0063	225mm/9"	-/12

#### Hedge shears (telescopic aluminum handle)

Carbon steel heat-treated, telescopic aluminum pipe handle with plastic grip  
Blade length: 250mm/10"  
Overall length: 570mm/860mm



ITEM NO.	SIZE	BOX(CTN/PCS)
A0064	250mm/10"	-/12

#### Hedge shears (metal handle)

Carbon steel heat-treated, metal handle with plastic grip  
Blade length: 250mm/10"  
Overall length: 550mm



ITEM NO.	SIZE	BOX(CTN/PCS)
A0066	250mm/11"	-/12

#### Hedge shears (telescopic metal handle)

Carbon steel heat-treated, telescopic metal pipe handle with plastic grip  
Blade length: 250mm/10"  
Overall length: 560mm/850mm



ITEM NO.	SIZE	BOX(CTN/PCS)
A0067	250mm/10"	-/12

#### Lopping shears

Max. capacity: DIA.40MM



ITEM NO.	SIZE	BOX(CTN/PCS)
A0268	750mm	-/12

#### Lopping shears telescopic aluminum handle

High carbon steel heat-treated, telescopic aluminum pipe handle with plastic grip  
Blade length: 125mm/5"  
Overall length: 710mm/1100mm  
Max. cutting capacity: fresh wood dia.35mm, hard wood dia.25mm



ITEM NO.	SIZE	BOX(CTN/PCS)
A0368	710mm/1100mm	-/12

#### Telescopic pruner & fruit picker

Max.length:4200mm

Cutter blades made of high carbon alloy steel, heat-treated for durability  
Aluminum telescopic handle for heavy duty operation  
Swivel cutting head for hard-to-reach areas



ITEM NO.	SIZE	BOX(CTN/PCS)
A0682	4200mm	-/12



### Shovel

- A0702 A0703 A0704P A0704S
- A0706 A0707 A0708 A0709
- A0694 A0695 A0696 A0697 A0698 A0699

#### Camping shovel



ITEM NO.	SIZE	BOX(CTN/PCS)
A0702	630mm	-/6

#### Stainless steel shovel



ITEM NO.	SIZE	BOX(CTN/PCS)
A0703	820mm	-/12

#### Pointed / square Shovel-High Carbon Steel



ITEM NO.	SIZE	BOX(CTN/PCS)
A0704P	230x270x470x1020mm	-/12
A0704S	230x270x470x1020mm	-/12

#### Metal shovel



ITEM NO.	SIZE	BOX(CTN/PCS)
A0706	Carbon steel	12/72

#### Cultihoe



ITEM NO.	SIZE	BOX(CTN/PCS)
A0707	Carbon steel	10/40

#### Stainless mini shovel ( wide ) Wooden handle



ITEM NO.	SIZE	BOX(CTN/PCS)
A0708	Stainless steel	12/-

#### Stainless mini shovel ( narrow ) Wooden handle



ITEM NO.	SIZE	BOX(CTN/PCS)
A0709	Stainless steel	12/-

#### Mini steel rake



Carbon steel heat-treated  
Hard wood handle

ITEM NO.	SIZE	BOX(CTN/PCS)
A0694		6/24

#### Mini steel hoe



Carbon steel heat-treated  
Hard wood handle

ITEM NO.	SIZE	BOX(CTN/PCS)
A0695		6/24

#### Two-way pick-hoe



Carbon steel heat-treated  
Hard wood handle

ITEM NO.	SIZE	BOX(CTN/PCS)
A0696		6/24

#### Two-way rake/hoe



Carbon steel heat-treated  
Hard wood handle

ITEM NO.	SIZE	BOX(CTN/PCS)
A0697		6/24

#### Hatchet

Carbon steel heat-treated  
Hard wood handle



ITEM NO.	SIZE	BOX(CTN/PCS)
A0698	375mm/14"	-/24

#### Hatchet

Carbon steel heat-treated  
Hard wood handle



ITEM NO.	SIZE	BOX(CTN/PCS)
A0699	400mm/16"	-/24





Utility saw

- A0192 A0292 A0193 A0192B A0292B
- A0892 A0992 A0993 A0194 A0692
- A0019 A0019B

Utility saw

High carbon steel heat treated  
Ground teeth with triple-side cutting edges insures  
long-time and easy operation  
Saw blades replaceable



ITEM NO.	SIZE	BOX(CTN/PCS)
A0192-210	210mm	6/24
A0192-240	240mm	6/24
A0192-270	270mm	6/24
A0192-300	300mm	6/24
A0192-350	350mm	6/24

Utility saw blade

High carbon steel heat treated  
Ground teeth with triple-side cutting edges insures  
long-time and easy operation  
Saw blades replaceable

ITEM NO.	SIZE	BOX(CTN/PCS)
A0192B-210	210mm	60/240
A0192B-240	240mm	60/240
A0192B-270	270mm	60/240
A0192B-300	300mm	60/240
A0192B-350	350mm	60/240

Utility saw



ITEM NO.	SIZE	BOX(CTN/PCS)
A0992	350mm	6/24

Multi Function Saw



ITEM NO.	SIZE	BOX(CTN/PCS)
A0993	350mm	6/24

Grafting knife



Stainless steel heat treated for durability  
Foldable blade for safe carriage

ITEM NO.	SIZE	BOX(CTN/PCS)
A0019		10/100

Utility folding saw

High carbon steel heat treated  
Ground teeth with triple-side cutting edges insures  
long-time and easy operation  
Saw blades replaceable



ITEM NO.	SIZE	BOX(CTN/PCS)
A0292-210	210mm	6/36
A0292-240	240mm	6/36
A0292-270	270mm	6/36

Utility folding saw

High carbon steel heat treated  
Ground teeth with triple-side cutting edges insures  
long-time and easy operation  
Saw blades replaceable



ITEM NO.	SIZE	BOX(CTN/PCS)
A0193-240	240mm	12/48

Hand saw



ITEM NO.	SIZE	BOX(CTN/PCS)
A0892-14	350mm/14"	12/48
A0892-16	400mm/16"	12/48
A0892-18	450mm/18"	12/48
A0892-20	500mm/20"	12/48

Folding saw



ITEM NO.	SIZE	BOX(CTN/PCS)
A0692-180	180mm	6/48

German type grafting knife



ITEM NO.	SIZE	BOX(CTN/PCS)
A0019B-R	Right	12/96
A0019B-L	Left	12/96

Hose nozzle

- M0001 M0002
- M0003 M0004
- M0005 M0011

Hose nozzle

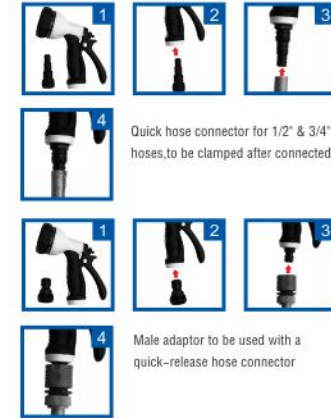

Quick hose connector for 1/2" & 3/4" hoses, to be clamped after connected

Male adaptor to be used with a quick-release hose connector

ITEM NO.	SIZE	BOX(CTN/PCS)
M0001		12/72

2 function hose nozzle

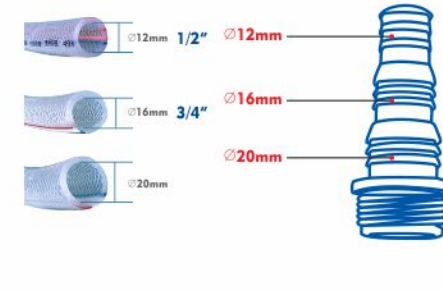

ITEM NO.	SIZE	BOX(CTN/PCS)
M0003		12/72

Hose nozzle set



ITEM NO.	SIZE	BOX(CTN/PCS)
M0005		12/72

8 function hose nozzle

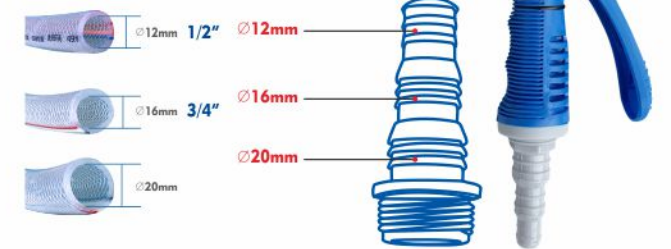

ITEM NO.	SIZE	BOX(CTN/PCS)
M0002		12/72

Gun nozzle with standard hose connector



- Continuously adjustable water flow from hard jet to fine mist.
- On/off trigger with lock.
- Ergonomically shaped trigger for easy and convenient use.
- Standard hose connector for connecting 13mm(1/2") hoses. Convenient leak-free connection of the spray gun to the hose. Also fits all other watering products.

ITEM NO.	SIZE	BOX(CTN/PCS)
M0004		10/60

Hose nozzle

Brass nozzle for long-time performance  
Impact plastic handle with steel lever  
Quick plastic coupler included



ITEM NO.	SIZE	BOX(CTN/PCS)
M0011		12/72



Portable hose reel set

- M0013 M0014 M0012
- M0010 M0010B
- M0006 M0007 M0008 M0009

**Elastic extendable water hose & nozzle set**

- ※ Extendable water hose with adaptor and hose nozzle.
- ※ Suitable for car and yacht washing, garden watering, floor and wall cleaning
- ※ Three layer latex for durability
- ※ Light weight and compact for easy storage



ITEM NO.	SIZE	BOX(CTN/PCS)
M0013-20	20m/65.5ft	1/-
M0013-30	30m/98ft	1/-

Portable hose reel set

- ※ Flattened water hose to fit into a more compact reel for easy carriage.
- ※ Suitable for car and yacht washing, garden watering, floor and wall cleaning



ITEM NO.	SIZE	BOX(CTN/PCS)
M0014-20	20m	1/-

**M0010 Universal Tap Connector**  
1/2"



Suitable for all 13mm(1/2 inch) water faucet with or without threads  
Used to attach a 1/2"(standard type) garden hose to round or oval spout taps  
The connector is sealed to the tap by tightening the stainless steel jubilee clip  
Used in conjunction with hose connectors.

ITEM NO.	SIZE	BOX(CTN/PCS)
M0010	13mm(1/2")	120/720
M0010B	13mm(1/2")	120/720

**M0010B Tap adaptor & hose connector**  
1/2"



Portable hose reel set

- 1 Portable hose reel set, a household necessity, suitable for car and yacht washing, garden watering, floor and wall cleaning
- 2 Easy to assemble, no tools needed
- 3 Steel pipe frame epoxy coated to resist corrosion
- 4 Standard accessories: 4 pieces of coupler and hose connectors, 1 piece 7-pattern hose nozzle



ITEM NO.	SIZE	BOX(CTN/PCS)
M0012	20m	1/3

**Hose connector**

1/2" M0006

3/4" M0007



Used for connection between hose and spraying equipment, suitable for 13mm (1/2inch) \19mm (3/4inch) hose

ITEM NO.	SIZE	BOX(CTN/PCS)
M0006	13mm(1/2")	120/720
M0007	19mm(3/4")	110/660

**Luxury dual use tap adaptor**

To be used in connection to screw faucet for mutual conversion between 1/2 inch and 3/4 inch (such as washing machine faucet).  
To be used in connection to screw faucet, suitable for 13mm(1/2 inch) hose

M0008 M0009



ITEM NO.	SIZE	BOX(CTN/PCS)
M0008	13mm(1/2")-19mm(3/4")	120/720
M0009	13mm(1/2")	120/720

**Axe | A0799**



Carbon steel heat treated  
Steel pipe handle with rubber grip

ITEM NO.	BOX(CTN/PCS)
A0799	6/24

Industrial grade grease gun

- BD-Y0020 BD-Y0021 BD-Y0022
- BD-Y0023 BD-Y0024 BD-Y0025

Extra heavy-duty construction ideal for automobile, machines and equipments  
Working pressure: 7000psi



ITEM NO.	SIZE	BOX(CTN/PCS)
BD-Y0020-400	400cc	-/12
BD-Y0020-600	600cc	-/12

Heavy-duty construction for professional operation and home use.  
Double air vent  
Working pressure: 6000psi



ITEM NO.	SIZE	BOX(CTN/PCS)
BD-Y0021	400cc	-/16

Heavy-duty construction for professional operation and D.I.Y. use.  
Both cartridge and bulk loading acceptable  
Working pressure: 6000psi



ITEM NO.	SIZE	BOX(CTN/PCS)
BD-Y0022	600cc	-/12

Heavy-duty construction for professional operation and D.I.Y. use.  
Both cartridge and bulk loading acceptable  
Working pressure: 6000psi



ITEM NO.	SIZE	BOX(CTN/PCS)
BD-Y0023	400cc	-/20

Heavy-duty construction for professional operation and D.I.Y. use.  
Both cartridge and bulk loading acceptable  
Working pressure: 6000psi



ITEM NO.	SIZE	BOX(CTN/PCS)
BD-Y0024	600cc	-/12

Light-weight and mini size make it an ideal tool for Light-duty and outdoor operation  
Working pressure: 3000psi



ITEM NO.	SIZE	BOX(CTN/PCS)
BD-Y0025	120cc	-/36

By-pass pruners

- BD-D0017 BD-D0018 BD035

Sk5 steel blade special treated for heavy-duty pruning work  
Metal handle vinyl-dipped  
Cutting capacity: fresh wood dia.20mm, dry wood dia.12mm



ITEM NO.	SIZE	BOX(CTN/PCS)
BD-D0017	200mm/8"	

Sk5 steel blade special treated for heavy-duty pruning work  
Metal handle vinyl-dipped  
Cutting capacity: fresh wood dia.20mm, dry wood dia.12mm



ITEM NO.	SIZE	BOX(CTN/PCS)
BD-D0018	200mm/8"	

Sk5 steel blade special treated for heavy-duty pruning work  
Aluminum handle vinyl-dipped with press-to-open lock  
Cutting capacity: fresh wood dia.20mm, dry wood dia.12mm



ITEM NO.	SIZE	BOX(CTN/PCS)
BD035	200mm/8"	

Multi-function electrician's tool

- BA0143 BA0144

Cable cutting: Capacity up to 16mm dia. cables

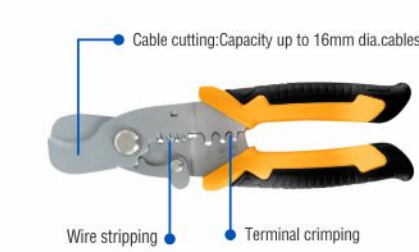

Wire stripping Terminal crimping

ITEM NO.	SIZE	BOX(CTN/PCS)
BA0143	175mm/7"	10/100

Multi-cutter: for cutting wire, cable, wiring duct and metal sheet

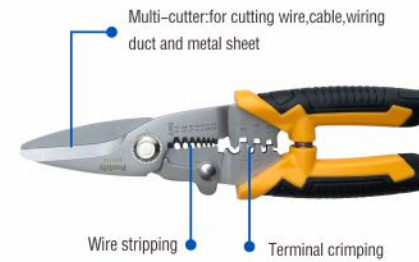

Wire stripping Terminal crimping

ITEM NO.	SIZE	BOX(CTN/PCS)
BA0144	200mm/8"	10/80

Hacksaw frame

- BD-C0003

All steel construction for heavy-duty work  
Pull open handle to change used blades  
Two saw blades included, one for steel, one for wood



ITEM NO.	SIZE	BOX(CTN/PCS)
BD-C0003	300mm/12"	6/24



### Self-clamping wrench set | BA0138

Auto-adjusting Claws 10-19mm/13-24mm  
Suitable For Hex And Square Nuts  
Ratchet Function  
Single-hand Operation



ITEM NO.	SIZE	BOX(CTN/PCS)
BA0138	200mm/8"	6/36

### Black try square | Y2-043 Y2-044



ITEM NO.	SIZE	BOX(CTN/PCS)
Y2-043	400x600x2.0mm	-/36
Y2-044	200x300x2.0mm	-/100

### Carving knife set | BC0055



ITEM NO.	SIZE	BOX(CTN/PCS)
BC0055	5-pc set	12/120

### Stainless steel scissors | BC0044

Materials:stainless steel blades; zing alloy handle.  
Blade hardness:hrc: 54-56.  
Most suitable for the following applications



ITEM NO.	SIZE	BOX(CTN/PCS)
BC0044	200mm/8"	12/120

### Pruning secateurs | BD053 BD054

Blades made from Japan SK5 steel with steel handle vinyl dipped for comfort  
Blade hardness:hrc:58-60.  
Cutting capacity: fresh tree branches 6mm and less in diameter; dry twigs 3mm and less.  
Best used for thinning and picking fruits or vegetables



ITEM NO.	SIZE	BOX(CTN/PCS)
BD053	150mm	12/120

Blades made from Japan SK5 steel with steel handle vinyl dipped for comfort  
Blade hardness:hrc:58-60.  
Cutting capacity: fresh tree branches 6mm and less in diameter; dry twigs 3mm and less.  
Best used for thinning and picking fruits or vegetables



ITEM NO.	SIZE	BOX(CTN/PCS)
BD054	150mm	12/120

### High pressure foot pump | BT0004 BT0005

Reinforced steel frame structure for heavy duty performance and durability  
Wider foot pedal for more steady pumping  
High quality pressure gauge for more precise reading  
Precision manufacturing ensures stronger and faster air flow



ITEM NO.	SIZE	BOX(CTN/PCS)
BT0004	Max pressure 700kpa	1/10

Reinforced steel frame structure for heavy duty performance and durability  
Wider foot pedal for more steady pumping  
High quality pressure gauge for more precise reading  
Precision manufacturing ensures stronger and faster air flow



ITEM NO.	SIZE	BOX(CTN/PCS)
BT0005	Max pressure 1000kpa	1/10

### Super pump | BT0001

Ø45x530mm

Extra thick pipe for faster and easy inflation  
Include schrader & presta valves  
Include 3 inflator needles  
Non-slip base



ITEM NO.	SIZE	BOX(CTN/PCS)
BT0001	Ø45x530mm	1/12

### Multi-purpose Lithium base grease | BH0009

Working temperature:100℃  
Dripping temperature:160℃  
Environment temperature:-20-120℃

Patented self-suction bucket for easy and clean grease loading



ITEM NO.	SIZE	BOX(CTN/PCS)
BH0009		

